



KISTENMACHER

Tools and Hardware





PASSION FOR QUALITY SINCE 1900

In the year 1888 a young boy named Ernst G. Kistenmacher joined his father, a German merchant, visiting an international trade fair in the city of Leipzig in Germany. The vibrant mood of foreign languages spoken by foreign people doing business on the trade fair captivated the boy immediately. Especially a group of Arab merchants dressed in their traditional robes fascinated him. The young boy followed the men and watched them spreading out prayer rugs on the ground and then starting to pray. Never ever in his life he could forget the image of these proud merchants interrupting their business to bow down in humility before God. And in that very moment he knew that one day he would visit their homeland to learn more about their culture, history and religion.

A few years later, the boy had become a young man in the meantime, he embarked on a nearly one year lasting business journey to the Middle East and India which was the

groundbreaking of his company
E.G. Kistenmacher GmbH & Co. KG.

Ever since then we are following the same path which the company took in its founding years: Our main focus always lies on the requirements of our customers and the best possible quality of our products!

Thanks to this philosophy we can look back on a history of more than one hundred successful years. And our today's customers in the Arab world as well as our suppliers in Germany rely on our partnership for several generations in the meantime.

We would be glad if we could count you to that circle of satisfied customers, too.

Faithfully yours,
E.G. Kistenmacher GmbH & Co. KG





OVERVIEW

Abrasives



Automotive Tools



Hand Tools



Lubrication Equipment



Crimping & Cutting

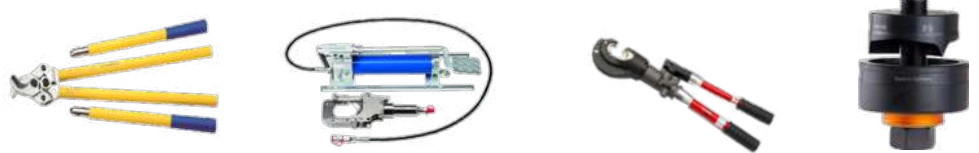

Compressed Air Tools



Workshop



Measurement



Industrial Accessories



Industrial Safety



Castor Wheels





Cutting & Grinding Discs - Stainless Steel



TECHNOFLEX KISTENMACHER brand Cutting Discs for Stainless Steel INOX Type A60T / A46T-BF

the composition of the discs prevents the formation of rust,
service life also good in normal steel with flat/depressed center

Art. No.	size (mm)	Ø (inch)	center
337222	100 x 1.0 x 16	4"	flat
299238	115 x 1.0 x 22.23	4.5"	flat
334235	115 x 1.6 x 22.23	4.5"	flat
337223	125 x 1.0 x 22.23	5"	flat
423449	180 x 1.6 x 22.23	7"	depressed
411609	230 x 1.9 x 22.23	9"	depressed

TECHNOFLEX KISTENMACHER brand Cutting Discs for Stainless Steel INOX Type AS30 S

the composition of the discs prevents the formation of rust,
service life also good in normal steel with depressed center

Art. No.	size (mm)	Ø (inch)	center
	100 x 3.0 x 16	4"	depressed
329471	115 x 3.0 x 22.23	4.5"	depressed
337224	125 x 3.0 x 22.23	5"	depressed
	180 x 3.0 x 22.23	7"	depressed
	230 x 3.0 x 22.23	9"	depressed



TECHNOFLEX KISTENMACHER brand Grinding Discs for Stainless Steel INOX Type A24 / 30Q-BF

good service and fast cutting all purpose disc - suitable for
grinding all types of metal, steel sheet and welding seams,
with depressed center

Art. No.	size (mm)	Ø (inch)	center
337226	100 x 6.5 x 16	4"	depressed
337227	115 x 6.5 x 22.23	4.5"	depressed
337228	125 x 6.5 x 22.23	5"	depressed
	150 x 6.5 x 22.23	6"	depressed
	180 x 6.5 x 22.23	7"	depressed
	230 x 6.5 x 22.23	9"	depressed



Cutting Discs

TECHNOFLEX KISTENMACHER brand Cutting Discs for Steel - Type A24 R-BF

good service and fast cutting all purpose disc,
suitable for cutting all types of metal

with depressed center
optionally with flat center

Art. No.	size (mm)	Ø (inch)	center
281370	100 x 3.0 x 16	4"	depressed
281371	115 x 3.0 x 22.23	4.5"	depressed
335480	125 x 3.0 x 22.23	5"	depressed
	150 x 3.0 x 22.23	6"	depressed
281372	180 x 3.0 x 22.23	7"	depressed
281373	230 x 3.0 x 22.23	9"	depressed



TECHNOFLEX KISTENMACHER brand Cutting Discs for Stone - Type C24 R-BF

good service and fast cutting all purpose disc,
suitable for cutting all types of stone, concrete, roof tiles, etc.

with depressed center
optionally with flat center

Art. No.	size (mm)	Ø (inch)	center
281792	100 x 3.0 x 16	4"	depressed
281793	115 x 3.0 x 22.23	4.5"	depressed
	125 x 3.0 x 22.23	5"	depressed
	150 x 3.0 x 22.23	6"	depressed
351034	180 x 3.0 x 22.23	7"	depressed
281794	230 x 3.0 x 22.23	9"	depressed



TECHNOFLEX KISTENMACHER brand Cutting Discs for Steel - Type A30/36 - stationary use

good service and fast cutting all purpose disc,
suitable for cutting all types of metal - flat center

Art. No.	size (mm)	finish
2301320	300 x 3.5 x 25.4	A 30 S ST (T41)
	305 x 2.8 x 25.4	A 36 S-BF ST (T41)
2351320	350 x 3.5 x 25.4	A 30 S ST (T41)
426200	356 x 3.0 x 25.4	A 36 P-BF ST (T41)
	400 x 3.2 x 25.4	A 36 S ST (T41)
2400020	400 x 4.0 x 25.4	AS 30 S ST (T41)





Grinding Discs



TECHNOFLEX KISTENMACHER brand Grinding Discs for Steel - Type A30T-BF T27

good service and fast cutting all purpose disc - suitable for grinding all types of metal, sheet steel and welding seams with depressed center

Art. No.	size (mm)	Ø (inch)	center
281376	100 x 6.5 x 16	4"	depressed
281377	115 x 6.5 x 22.23	4.5"	depressed
	125 x 6.5 x 22.23	5"	depressed
	150 x 6.5 x 22.23	6"	depressed
281378	180 x 6.5 x 22.23	7"	depressed
281381	230 x 6.5 x 22.23	9"	depressed

TECHNOFLEX KISTENMACHER brand Grinding Discs for Stone - Type C30S-BF

good all purpose disc - with durable service life for all types of stone, concrete, root tiles, etc. with depressed center

Art. No.	size (mm)	Ø (inch)	center
	100 x 6.5 x 16	4"	depressed
3116660	115 x 6.5 x 22.23	4.5"	depressed
3126660	125 x 6.5 x 22.23	5"	depressed
3156660	150 x 6.5 x 22.23	6"	depressed
3186660	180 x 6.5 x 22.23	7"	depressed
3236660	230 x 6.5 x 22.23	9"	depressed



TECHNOFLEX KISTENMACHER brand Cup Grinding Wheels for Stone - C24 N-B

with thread M14

Art. No.	size (mm)	grit
CG STN16	110 x 90 x 55	16
CG STN24	110 x 90 x 55	24
CG STN36	110 x 90 x 55	36



TECHNOFLEX KISTENMACHER brand Cup Grinding Wheels for Steel - A24 N-B

with thread M14

Art. No.	size (mm)	grit
CG STL16	110 x 90 x 55	16
CG STL24	110 x 90 x 55	24
CG STL36	110 x 90 x 55	36



Flap Discs

TECHNOFLEX KISTENMACHER brand Abrasive Flap Discs ECO Type 300 GT-S29

with fibreglass backing, suitable for steel, nonferrous and aluminium material, with depressed center

Art. No.	size (mm)	grit
370 115 EGK 40	115 x 22,2	40
370 115 EGK 60	115 x 22,2	60
370 115 EGK 80	115 x 22,2	80
370 115 EGK 120	115 x 22,2	120

Art. No.	size (mm)	grit
370 125 EGK 40	125 x 22,2	40
370 125 EGK 60	125 x 22,2	60
370 125 EGK 80	125 x 22,2	80
370 125 EGK 120	125 x 22,2	120



TECHNOFLEX KISTENMACHER brand Abrasive Flap Discs PRO GT-S Type 303 VT 29

with fibreglass backing, suitable for steel, stainless steel, with depressed center

Art. No.	size (mm)	grit
373 115 EGK 40	115 x 22,2	40
373 115 EGK 60	115 x 22,2	60
373 115 EGK 80	115 x 22,2	80
373 115 EGK 120	115 x 22,2	120

Art. No.	size (mm)	grit
373 125 EGK 40	125 x 22,2	40
373 125 EGK 60	125 x 22,2	60
373 125 EGK 80	125 x 22,2	80
373 125 EGK 120	125 x 22,2	120



Abrasives

VSM brand Vulcanfibre Discs - KF 708

for steel, shape S1 E

Art. No.	size (mm)	grain
727802	115 x 22	16
727803	115 x 22	24
727805	115 x 22	36
727806	115 x 22	40
727807	115 x 22	50
727808	115 x 22	60
727809	115 x 22	80
727810	115 x 22	100
727811	115 x 22	120



Art. No.	size (mm)	grain
727855	180 x 22	16
727856	180 x 22	24
727858	180 x 22	36
727859	180 x 22	40
727860	180 x 22	50
727861	180 x 22	60
727862	180 x 22	80
727863	180 x 22	100
727864	180 x 22	120

VSM brand Vulcanfibre Discs - KF 713

for stainless steel, shape S1 E

Art. No.	size (mm)	grain
728378	115 x 22	24
728379	115 x 22	36
728380	115 x 22	40
728381	115 x 22	50
728382	115 x 22	60
728383	115 x 22	80
728384	115 x 22	100
728385	115 x 22	120



Art. No.	size (mm)	grain
728414	180 x 22	24
728415	180 x 22	36
728416	180 x 22	40
728417	180 x 22	50
728418	180 x 22	60
728419	180 x 22	80
728420	180 x 22	100
728421	180 x 22	120

VSM brand Vulcanfibre Discs - SF 08

for stone, shape S1 E

Art. No.	size (mm)	grain
728313	115 x 22	24
728314	115 x 22	36
728316	115 x 22	60
728317	115 x 22	80
728319	115 x 22	120

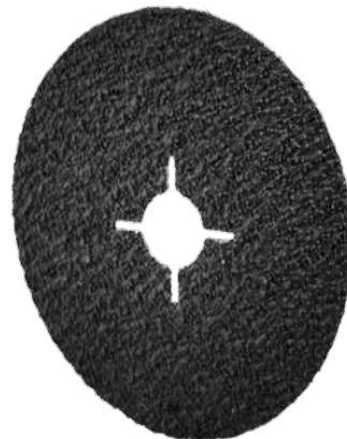

Art. No.	size (mm)	grain
728337	180 x 22	16
728338	180 x 22	24
728339	180 x 22	36
728341	180 x 22	60
728342	180 x 22	80
728343	180 x 22	120

Abrasives

VSM brand fibrs disc - Type XF870

ceramic - for all kinds of steel, very good on stainless steels or superalloys, very long lifetime - aggressive cut

Art. No.	size	grit
737048	115 x 22 mm	24
731252	115 x 22 mm	36
731254	115 x 22 mm	40
731255	115 x 22 mm	50
731257	115 x 22 mm	60
731258	115 x 22 mm	80
737045	115 x 22 mm	100
731259	115 x 22 mm	120

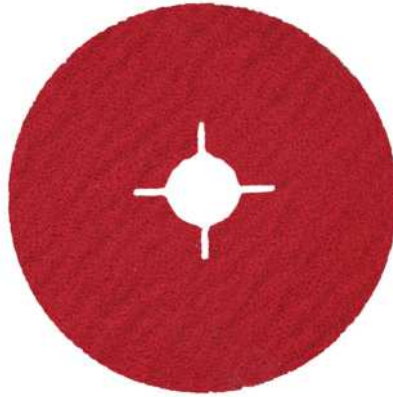

Art. No.	size	grit
737053	180 x 22 mm	24
731273	180 x 22 mm	36
731274	180 x 22 mm	40
731275	180 x 22 mm	50
731276	180 x 22 mm	60
731277	180 x 22 mm	80
737052	180 x 22 mm	100
731278	180 x 22 mm	120

VSM brand fibre disc - Type XF733

ceramic - for aluminium, unalloyed steel, non-ferrous metal, reduces the adhesion of the material to the abrasive grain, very long service life - self sharpening effect

Art. No.	size	grain
787856	115 x 22 mm	24
787587	115 x 22 mm	36
787588	115 x 22 mm	60
787591	115 x 22 mm	80



Art. No.	size	grain
787601	180 x 22mm	24
787602	180 x 22mm	36
787609	180 x 22mm	60
787611	180 x 22mm	80

VSM brand fibre disc - Type KP131K

aluminium oxide - for wood and lacquer. On velour backed paper backing for self-sticking systems - lowrisk of clogging -

Art. No.	size	grain
714302	150 x 18 mm	60
714303	150 x 18 mm	80
714304	150 x 18 mm	100
745952	150 x 18 mm	120
714313	150 x 18 mm	150

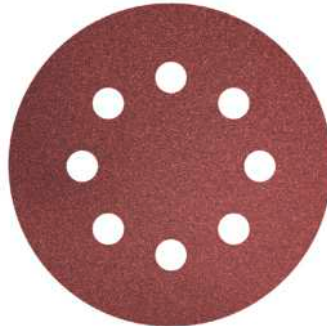

Art. No.	size	grain
714317	150 x 18 mm	180
714318	150 x 18 mm	240
714287	150 x 18 mm	320
714321	150 x 18 mm	400

VSM brand Cut-roll Abrasive Cloth - Type KK114F

aluminium oxide - for universal use, very flexible cotton cloth - backing F-cotton

Art. No.	size	grit
720569	100 mm x 50 mtr	40
720571	100 mm x 50 mtr	60
720572	100 mm x 50 mtr	80
720573	100 mm x 50 mtr	100
720574	100 mm x 50 mtr	120
720575	100 mm x 50 mtr	150



Art. No.	size	grit
720576	100 mm x 50 mtr	180
720577	100 mm x 50 mtr	220
720578	100 mm x 50 mtr	240
720580	100 mm x 50 mtr	320
720582	100 mm x 50 mtr	400

also available in width of 25, 30, 40, 50, 115, 120 mm

Abrasives

Backing pads with and without Velcro-Fastener

good scratch pattern due to damping and flexibility of backing pad, with M10/14 thread



Art. No.	size (inch)	description
6211205	4 1/2"	M14 with velcro
6212205	5	M14 with velcro
6218205	7	M14 with velcro
6211100	4 1/2"	M10 without velcro
6211105	4 1/2"	M14 without velcro
6212105	5	M14 without velcro
6218105	7	M14 without velcro



KISTENMACHER brand Abrasive Flap Wheels

for metal, wood and plastic, with 6.0 mm shaft



Art. No.	D (mm)	B (mm)	S (mm)	P (mm)
100 40206 EGK 40	040	020	6	40
100 40206 EGK 60	040	020	6	60
100 40206 EGK 80	040	020	6	80
100 40206 EGK120	040	020	6	120
100 50206 EGK 40	050	020	6	40
100 50206 EGK 60	050	020	6	60
100 50206 EGK 80	050	020	6	80
100 50206 EGK120	050	020	6	120
100 50306 EGK 40	050	030	6	40
100 50306 EGK 60	050	030	6	60
100 50306 EGK 80	050	030	6	80
100 50306 EGK120	050	030	6	120
100 60306 EGK 40	060	030	6	40
100 60306 EGK 60	060	030	6	60
100 60306 EGK 80	060	030	6	80
100 60306 EGK120	060	030	6	120

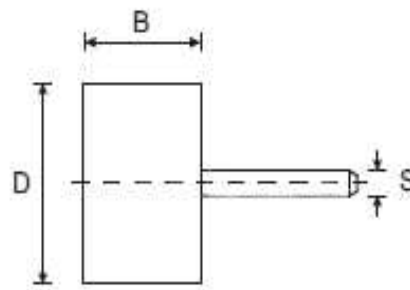

Other sizes and grits available upon request

Abrasives

TECHNOFLEX KISTENMACHER brand Unmounted Abrasive Flap Wheels Type 200

deburring, deflashing, cleaning, light grinding and mat finishing
for stainless steel, light aluminium, wood and plastic
available with bore 25,0 mm and 25,5 mm



Art. No.	plus grit	size (mm)	available grits
200 1002525 EGK	___	100 x 025 x 025	040-060-080-100-120-150-180-240-280-320
200 1003025 EGK	___	100 x 030 x 025	040-060-080-100-120-150-180-240-280-320
200 1202525 EGK	___	120 x 025 x 025	040-060-080-100-120-150-180-240-280-320
200 1203025 EGK	___	120 x 030 x 025	040-060-080-100-120-150-180-240-280-320
200 1303025 EGK	___	130 x 025 x 025	040-060-080-100-120-150-180-240-280-320
200 1303025 EGK	___	130 x 030 x 025	040-060-080-100-120-150-180-240-280-320
200 1402525 EGK	___	140 x 025 x 025	040-060-080-100-120-150-180-240-280-320
200 1403025 EGK	___	140 x 030 x 025	040-060-080-100-120-150-180-240-280-320
200 1405025 EGK	___	140 x 050 x 025	040-060-080-100-120-150-180-240-280-320

Art. No.	plus grit	size (mm)	size (inch)	recess	available grits
202 1502532 EGK	___	150 x 025 x 032	6 x 1 x 1"	2 x Ø 51x5	040-060-080-100-120-150-180-240-280-320
202 1503032 EGK	___	150 x 030 x 032		2 x Ø 51x7	040-060-080-100-120-150-180-240-280-320
202 1505032 EGK	___	150 x 050 x 032		2 x Ø 51x15	040-060-080-100-120-150-180-240-280-320
202 1652532 EGK	___	165 x 025 x 032		2 x Ø 51x5	040-060-080-100-120-150-180-240-280-320
202 1653032 EGK	___	165 x 030 x 032		2 x Ø 51x7	040-060-080-100-120-150-180-240-280-320
202 1655032 EGK	___	165 x 050 x 032		2 x Ø 51x15	040-060-080-100-120-150-180-240-280-320
202 2002551 EGK	___	200 x 025 x 051	8 x 1 x 2"	2 x Ø 76x5	040-060-080-100-120-150-180-240-280-320
202 2003051 EGK	___	200 x 030 x 051		2 x Ø 51x7	040-060-080-100-120-150-180-240-280-320
202 2005051 EGK	___	200 x 050 x 051		2 x Ø 76x15	040-060-080-100-120-150-180-240-280-320

TECHNOFLEX KISTENMACHER brand Flanges for Recessed Abrasive Flap Wheels Type 202

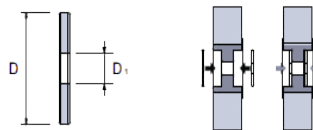

Art. No. plus borehole size	size D x D (mm)	for wheel-diameter (mm)	available borehole sizes
202 051 000 EGK	51 x 10	150, 165	010-012-014-015-016-020-025
202 076 000 EGK	76 x 10	200	014-015-016-020-025-030-032

Brushes

Pipeline- / Joint-Brushes, knotted

optimal brushes for pipeline and piping construction
 steel wire 0.50 mm
 stainless steel wire 0.50 mm

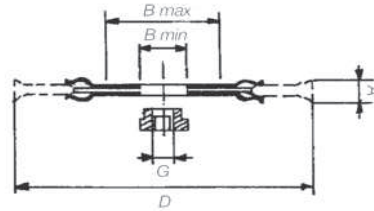

Art. No. steel wire	Art. No. stainless steel wire	D Ø (mm)	knots	bore (mm)	G thread	A (mm)	RPM (1/min)
110007350	110007250	100	24	22,2		6	12000
110017350	110017250	100	24		M14	6	12000
111507350	111507250	115	24	22,2		6	12000
111517350	111517250	115	24		M14	6	12000
112507350	112507250	125	40	22,2		6	12000
112517350	112517250	125	40		M14	6	12000
115007350	115007250	150	40	22,2		6	9000
115017350	115017250	150	40		M14	6	9000
117807350	117807250	178	64	22,2		6	9000
117817350	117817250	178	64		M14	6	9000

Conical Brushes, knotted

efficient in corners and at edges
 steel wire 0.50 mm
 stainless steel wire 0.50 mm

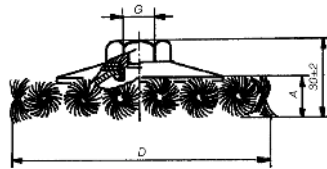

Art. No. steel wire	Art. No. stainless steel wire	D Ø (mm)	knots	G thread	A (mm)	RPM (1/min)
410014350	410014250	100	18	M14	13	12000
410012350		100	22	M14	13	12000
411514350	411514250	115	18	M14	13	12000
411512350	411512250	115	20	M14	13	12000
412513350	412513250	125	20	M14	13	10000
418513350		185	36	M14	13	4500
418503350		185	36	B22,2	13	4500

Knotted Cup Brushes

high removal rate a high rotation
 steel wire 0.50 mm
 brass wire 0.50 mm
 stainless steel wire 0.50 mm

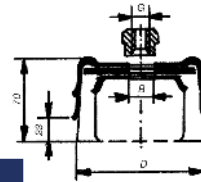

Art. No. steel wire	Art. No. brass wire	Art. No. stainless steel wire	D Ø (mm)	knots	bore (mm)	G thread	A (mm)	RPM (1/min)
203513350			35*	16		M14	1	12000
204513350			45*	16		M14	1	12000
206516350	206516150		65	18		M14	1	12000
208004350	208004150	208004250	80	22	22,2		1	10500
208014350	208014150	208014250	80	22		M14	1	10500
210004350	210004150	210004250	100	30	22,2		1	8500
210014350	210014150	210014250	100	30		M14	1	8500
212004350	212004150	212004250	120	36	22,2		1	6500
212014350	212014150	212014250	120	36		M14	1	6500

Brushes

Surface Cleaning Brushes, crimped wire

effective on surfaces
 steel wire 0.30 mm
 brass wire 0.30 mm
 stainless steel wire 0.30 mm



Art. No. steel wire	Art. No. brass wire	Art. No. stainless steel wire	D Ø (mm)	B bore / G thread	RPM (1/min)
606026330	606026130	606024230	60	16	12000
606016330	606016130	606014230	60	M14	12000
607526330	607526130	607524230	75	16	10000
607516330	607516130	607514230	75	M14	10000
608003330	608003130	608004230	80	22,2	10000
608013330	608013130	608014230	80	M14	10000
610003330	610003130	610004230	100	22,2	8500
610013330	610013130	610014230	100	M14	8500
612503330	612503130	612503230	125	22,2	6500
612513330	612513130	612513230	125	M14	6500
615003330	615003130	615003230	150	22,2	4500
615013335	615013130	615013230	150	M14	4500

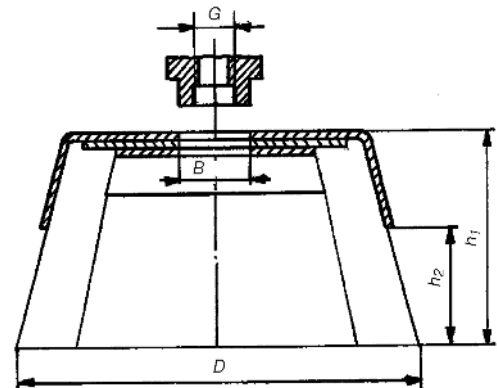

6 mm Shank Wheel Brushes crimped wire

steel wire 0.30 mm
 brass wire 0.20 mm
 stainless steel wire 0.30 mm



Art. No. steel wire	Art. No. brass wire	Art. No. stainless steel wire	D Ø (mm)	A (mm)	RPM (1/min)
	802006120		20	6	20000
803008330	803008120	803008230	30	7 - 8	20000
804011330	804011120	804011230	40	10 - 12	18000
805008330			50	8 - 10	4500
805011330	805011120	805011230	50	10 - 12	15000
805017330	805017120	805017230	50	16 - 18	15000
806012330	806012120	806012230	60	10 - 12	15000
806018330	806018120	806018230	60	16 - 18	15000
807012330	807012120	807012230	70	10 - 12	15000
807018330	807018120	807018230	70	17 - 19	15000
807510330	807510120	807510230	75	8 - 10	4500
808012330	808012120	808012230	80	12 - 14	15000
808019330	808019120	808019230	80	18 - 20	15000
810010335	810010130	810010230	100	8 - 10	10000



6 mm Shank Cup Brushes crimped wire

steel wire 0.30 / 0.35 mm
 brass wire 0.20 / 0.25 mm
 stainless steel wire 0.30 / 0.35 mm

Art. No. steel wire	Art. No. brass wire	Art. No. stainless steel wire	D Ø (mm)	RPM (1/min)
605071330	605071120	605071230	50	4500
605071335	605171125	605071235	50	4500
607071330	607071120	605071230	70	4500
607571335	607571125	605071235	75	4500



6 mm Shank Wheel and Cup Brushes, knotted

steel wire 0.50 mm
 stainless steel wire 0.50 mm

Art. No. steel wire	Art. No. stainless steel wire	D Ø (mm)	A (mm)	rows	RPM (1/min)
107571350	107571250	75	16	1	20000
109071350	109071250	90	16	1	20000
107081350	107081250	70	16	2	20000
305571350	305571250	55	16	1	6000

Brushes

Tube brushes with external M12 / 1/2" thread available in

steel wire 0.35 mm straight
 steel wire 0.30 mm crimped
 brass wire 0.30 mm crimped



Art. No. straight steel wire	Art. No. crimped steel wire	Art. No. crimped brass wire	(mm) Ø
090203	09020330	09020130	20
090223	09022330	09022130	22
090253	09025330	09025130	25
090303	09030330	09030130	30
090323	09032330	09032130	32
090383	09038330	09038130	38
090443	09044330	09044130	44
090503	09050330	09050130	50
090573	09057330	09057130	57
090633	09063330	09063130	63
090693	09069330	09069130	69
090753	09075330	09075130	75
090823	09082330	09082130	82
090943	09094330	09094130	94
091013	09101330	09101130	101

Hand Wire Brushes

suitable for derusting, removal of paint residues and cleaning,
 4-rows, in cartons of 12 pcs.

also available in 3-rows and 5-rows



straight steel wire: 001.143523

crimped brass wire: 002.243523

straight stainless steel wire:
 (INOX): 004.1431230



Spark Plug Brushes

for automotive workshops and fine machining, 3-rows

Art. No.	13115	crimped brass wire 0.15 mm
Art. No.	13120	crimped brass wire 0.20 mm
Art. No.	13125	crimped brass wire 0.25 mm



File Cards

for cleaning wood and metal files, file length 100 mm

Art. No.	280225	200 x 25 mm
Art. No.	280240	200 x 40 mm
Art. No.	280250	200 x 50 mm



Street Brooms

wooden body,
 with straight red PVC bristles



Art. No.	size (cm)	rows
10316	29	5
10916	40	6
12516	50	6
13016	60	6

Floor Brooms

wooden body,
 with straight black PVC bristles



Art. No.	size (cm)
23010	30
24010	40
25010	50
26010	60

Floor Squeegees

with metal support



Art. No.	size (cm)
36235	35
36245	45
36260	60

Combination Spanners



Combination Spanners - Type 300

chrome-vanadium steel, chrome plated
ring 15° offset, DIN 3113 B

WIESEMANN 1893
GERMANY

Art. No.	size (mm)	Art. No.	size (mm)
300c07	7	300c16	16
300c08	8	300c17	17
300c09	9	300c19	19
300c10	10	300c22	22
300c11	11	300c23	23
300c12	12	300c46	46
300c13	13	300c50	50
300c14	14	300c55	55
300c15	15		

Combination Spanners - Type 350 - Short Pattern

chrome-vanadium steel, chrome plated
ring 15° offset, DIN 3113 A

Art. No.	size (mm)	Art. No.	size (mm)
350c06	6	350c18	18
350c07	7	350c19	19
350c08	8	350c20	20
350c09	9	350c21	21
350c10	10	350c22	22
350c11	11	350c23	23
350c12	12	350c24	24
350c13	13	350c27	27
350c14	14	350c30	30
350c15	15	350c32	32
350c16	16	350c34	34
350c17	17	350c36	36

Art. No.	size (inch)	Art. No.	size (inch)	Art. No.	size (inch)
3500001c	1/4	3500007c	19/32	3500014c	15/16
3500002c	5/16	3500008c	5/8	3500015c	1
3500003c	3/8	3500009c	11/16	3500016c	1.1/16
3500004c	7/16	3500010c	3/4	3500017c	1.1/8
3500005c	1/2	3500012c	13/16	3500019c	1.1/4
3500006c	9/16	3500013c	7/8		





Double Ended Ring Spanners



Double Ended Ring Spanners - Type 100

chrome-vanadium steel, chrome plated
deep offset

WIESEMANN 1893

GERMANY

Art. No.	size (mm)	Art. No.	size (mm)	Art. No.	size (mm)
100c0607	6 x 7	100c1317	13 x 17	100c2426	24 x 26
100c0708	7 x 8	100c1415	14 x 15	100c2427	24 x 27
100c0809	8 x 9	100c1417	14 x 17	100c2430	24 x 30
100c0810	8 x 10	100c1617	16 x 17	100c2528	25 x 28
100c0911	9 x 11	100c1618	16 x 18	100c2730	27 x 30
100c1011	10 x 11	100c1719	17 x 19	100c2732	27 x 32
100c1012	10 x 12	100c1722	17 x 22	100c3032	30 x 32
100c1013	10 x 13	100c1819	18 x 19	100c3034	30 x 34
100c1113	11 x 13	100c1821	18 x 21	100c3036	30 x 36
100c1213	12 x 13	100c1922	19 x 22	100c3236	32 x 36
100c1214	12 x 14	100c1924	19 x 24	100c3436	34 x 36
100c1314	13 x 14	100c2022	20 x 22	100c3641	36 x 41
100c1315	13 x 15	100c2123	21 x 23	100c4146	41 x 46
100c1316	13 x 16	100c2224	22 x 24	100c4650	46 x 50

Art. No.	size (inch)	Art. No.	size (inch)	Art. No.	size (inch)
1000001c	1/4 x 5/16	1000006c	9/16 x 5/8	1000010c	3/4 x 7/8
1000002c	5/16 x 3/8	1000007c	19/32 x 11/16	1000011c	13/16 x 7/8
1000003c	3/8 x 7/16	1000008c	5/8 x 11/16	1000012c	15/16 x 1
1000004c	7/16 x 1/2	1000009c	5/8 x 3/4	1000014c	1.1/16 x 1.1/4
1000005c	1/2 x 9/16				

Double Ended Spanners - Type 150 - Short Pattern

chrome-vanadium steel, chrome plated
deep offset

Art. No.	size (mm)	Art. No.	size (mm)	Art. No.	size (mm)
150c0607	6 x 7	150c1415	14 x 15	150c2123	21 x 23
150c0809	8 x 9	150c1617	16 x 17	150c2426	24 x 26
150c1011	10 x 11	150c1819	18 x 19	150c2528	25 x 28
150c1213	12 x 13	150c2022	20 x 22	150c2732	27 x 32



Double Ended Open Spanners



Double Ended Open Jaw Spanners Type 200

chrome-vanadium steel, chrome plated

WIESEMANN 1893
GERMANY

Art. No.	size (mm)	Art. No.	size (mm)	Art. No.	size (mm)
200c55007	5,5 x 7	200c1214	12 x 14	200c2123	21 x 23
200c0607	6 x 7	200c1314	13 x 14	200c2224	22 x 24
200c0708	7 x 8	200c1315	13 x 15	200c2426	24 x 26
200c0709	7 x 9	200c1317	13 x 17	200c2427	24 x 27
200c0809	8 x 9	200c1415	14 x 15	200c2528	25 x 28
200c0810	8 x 10	200c1417	14 x 17	200c2730	27 x 30
200c0910	9 x 10	200c1617	16 x 17	200c2732	27 x 32
200c0911	9 x 11	200c1618	16 x 18	200c3032	30 x 32
200c1011	10 x 11	200c1719	17 x 19	200c3036	30 x 36
200c1012	10 x 12	200c1722	17 x 22	200c3236	32 x 36
200c1013	10 x 13	200c1819	18 x 19	200c3436	34 x 36
200c1113	11 x 13	200c1922	19 x 22	200c3641	36 x 41
200c1114	11 x 14	200c1924	19 x 24	200c4146	41 x 46
200c1213	12 x 13	200c2022	20 x 22	200c4650	46 x 50

Art. No.	size (inch)	Art. No.	size (inch)	Art. No.	size (inch)
2000001c	1/4 x 5/16	2000007c	9/16 x 5/8	2000012c	3/4 x 7/8
2000002c	5/16 x 3/8	2000008c	19/32 x 11/16	2000013c	13/16 x 7/8
2000003c	3/8 x 7/16	2000009c	5/8 x 11/16	2000014c	15/16 x 1
2000004c	7/16 x 1/2	2000010c	5/8 x 3/4	2000016c	1.1/16 x 1.1/4
2000005c	1/2 x 9/16				

Double Ended Open Jaw Spanners - Type 250 - Short Pattern

chrome-vanadium steel, chrome plated

Art. No.	size (mm)	Art. No.	size (mm)	Art. No.	size (mm)
250c0607	6 x 7	250c1415	14 x 15	250c2123	21 x 23
250c0809	8 x 9	250c1617	16 x 17	250c2426	24 x 26
250c1011	10 x 11	250c1819	18 x 19	250c2528	25 x 28
250c1213	12 x 13	250c2022	20 x 22	250c2732	27 x 32



Spanner Sets

Combination Spanner Sets

chrome-vanadium steel, chrome plated
in carton box

WIESEMANN 1893
GERMANY

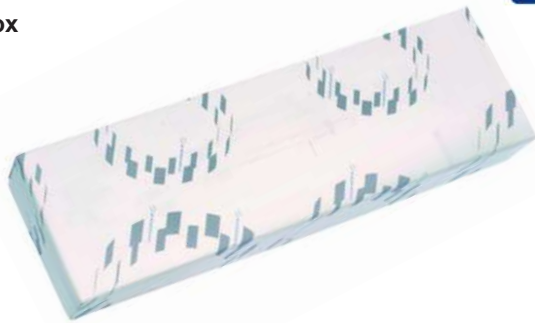

Art. No.	pcs per set	sizes
350 K6/c/S	6	8, 10, 11, 13, 17, 19
350 K8/c	8	8, 10, 11, 13, 14, 17, 19, 22
350 K12/c/6-32	12	6, 7, 8, 10, 12, 13, 14, 17, 19, 22, 27, 32
350K 6ac	6	3/8, 7/16, 1/2, 9/16, 5/8, 3/4
350K 8ac	8	1/4, 5/16, 3/8, 7/16, 1/2, 9/16, 5/8, 3/4
350K 12ac	12	1/4, 5/16, 3/8, 7/16, 1/2, 9/16, 5/8, 3/4, 7/8, 1.1/16, 1.1/4

Combination Spanner Sets

chrome-vanadium steel, chrome plated
in plastic wallet

Art. No.	pcs per set	sizes
350 T8/c	8	8, 9, 10, 11, 13, 14, 17, 19
350 T8/c/S	8	8, 10, 11, 13, 14, 17, 19, 22
350 T12/c/6-22	12	6, 7, 8, 9, 10, 11, 12, 13, 14, 17, 19, 22
350 T12/c/6-32	12	6, 8, 10, 13, 14, 17, 19, 22, 24, 27, 30, 32
350 T12/c/S6-32/S	12	6, 8, 10, 12, 13, 14, 17, 19, 22, 24, 27, 32
350 T12/cfAH	12	6, 7, 8, 10, 12, 13, 14, 17, 19, 22, 27, 32



Double Ended Ring Spanner Sets

chrome-vanadium steel, chrome plated
Type 100 - deep offset
Type 150 - short pattern offset

in carton box

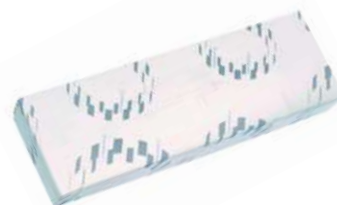

Art. No.	pcs per set	sizes
100 K8/c	8	6 x 7, 8 x 9, 10 x 11, 12 x 13, 14 x 15, 16 x 17, 18 x 19, 20 x 22
100 K12/c	12	6 x 7, 8 x 9, 10 x 11, 12 x 13, 14 x 15, 16 x 17, 18 x 19, 20 x 22, 21 x 23, 24 x 26, 25 x 28, 27 x 32
100 K 6ac	6	3/8 x 7/16, 1/2 x 9/16, 19/32 x 11/16, 5/8 x 3/4, 13/16 x 7/8, 15/16 x 1
100 K 8ac	8	1/4 x 5/16, 3/8 x 7/16, 1/2 x 9/16, 19/32 x 11/16, 5/8 x 3/4, 13/16 x 7/8, 15/16 x 1, 1.1/16 x 1.1/4
150 K6/c	6	6 x 7, 8 x 9, 10 x 11, 12 x 13, 14 x 15, 16 x 17
150 K8/c	8	6 x 7, 8 x 9, 10 x 11, 12 x 13, 14 x 15, 16 x 17, 18 x 19, 20 x 22
150 K12/c	12	6 x 7, 8 x 9, 10 x 11, 12 x 13, 14 x 15, 16 x 17, 18 x 19, 20 x 22, 21 x 23, 24 x 26, 25 x 28, 27 x 32

Spanner Sets



Double Ended Ring Spanner Sets

chrome-vanadium steel, chrome plated
 Type 100 - deep offset
 Type 150 - short pattern offset

in plastic wallet

WIESEMANN 1893
 GERMANY



Art. No.	pcs per set	sizes
100 T 8/c	8	6 x 7, 8 x 9, 10 x 11, 12 x 13, 14 x 15, 16 x 17, 18 x 19, 20 x 22
100 T12/c	12	6 x 7, 8 x 9, 10 x 11, 12 x 13, 14 x 15, 16 x 17, 18 x 19, 20 x 22, 21 x 23, 24 x 26, 25 x 28, 27 x 32
150 T 6/c	6	6 x 7, 8 x 9, 10 x 11, 12 x 13, 14 x 15, 16 x 17
150 T 8/c	8	6 x 7, 8 x 9, 10 x 11, 12 x 13, 14 x 15, 16 x 17, 18 x 19, 20 x 22
150 T12/c	12	6 x 7, 8 x 9, 10 x 11, 12 x 13, 14 x 15, 16 x 17, 18 x 19, 20 x 22, 21 x 23, 24 x 26, 25 x 28, 27 x 32

Double Ended Open Jaw Spanner Sets

Type 200 - deep
 Type 250 - short pattern

in carton box

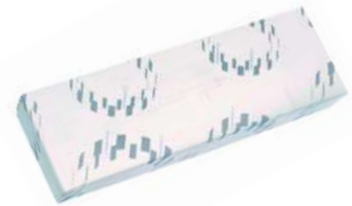

Art. No.	pcs per set	sizes
200 K 8/c	8	6 x 7, 8 x 9, 10 x 11, 12 x 13, 14 x 15, 16 x 17, 18 x 19, 20 x 22
200 K 12/c	12	6 x 7, 8 x 9, 10 x 11, 12 x 13, 14 x 15, 16 x 17, 18 x 19, 20 x 22, 21 x 23, 24 x 26, 25 x 28, 27 x 32
250 K 6ac	6	3/8 x 7/16, 1/2 x 9/16, 19/32 x 11/16, 5/8 x 3/4, 13/16 x 7/8, 15/16 x 1
250 K 8ac	8	1/4 x 5/16, 3/8 x 7/16, 1/2 x 9/16, 19/32 x 11/16, 5/8 x 3/4, 13/16 x 7/8, 15/16 x 1, 1.1/16 x 1.1/4
250 K 6/c	6	6 x 7, 8 x 9, 10 x 11, 12 x 13, 14 x 15, 16 x 17
250 K 8/c	8	6 x 7, 8 x 9, 10 x 11, 12 x 13, 14 x 15, 16 x 17, 18 x 19, 20 x 22
250 K 12/c	12	6 x 7, 8 x 9, 10 x 11, 12 x 13, 14 x 15, 16 x 17, 18 x 19, 20 x 22, 21 x 23, 24 x 26, 25 x 28, 27 x 32

Double Ended Open Jaw Spanner Sets

Type 200
 Type 250 - short pattern

in plastic wallet



Art. No.	pcs per set	sizes
200 T 8/c	8	6 x 7, 8 x 9, 10 x 11, 12 x 13, 14 x 15, 16 x 17, 18 x 19, 20 x 22
200 T12/c	12	6 x 7, 8 x 9, 10 x 11, 12 x 13, 14 x 15, 16 x 17, 18 x 19, 20 x 22, 21 x 23, 24 x 26, 25 x 28, 27 x 32
250 T 6/c	6	6 x 7, 8 x 9, 10 x 11, 12 x 13, 14 x 15, 16 x 17
250 T 8/c	8	6 x 7, 8 x 9, 10 x 11, 12 x 13, 14 x 15, 16 x 17, 18 x 19, 20 x 22
250 T 12/c	12	6 x 7, 8 x 9, 10 x 11, 12 x 13, 14 x 15, 16 x 17, 18 x 19, 20 x 22, 21 x 23, 24 x 26, 25 x 28, 27 x 32

Slogging Wrenches



Slogging Ring Wrenches

special drop forged steel

WIESEMANN 1893
GERMANY



Art. No.	size (mm)	Art. No.	size (mm)	Art. No.	size (mm)
600sg24	24	600sg70	70	600sg70	130
600sg27	27	600sg75	75	600sg75	135
600sg30	30	600sg80	80	600sg80	140
600sg32	32	600sg85	85	600sg85	145
600sg36	36	600sg90	90	600sg90	150
600sg38	38	600sg95	95	600sg95	155
600sg41	41	600sg100	100	600sg100	160
600sg46	46	600sg105	105	600sg105	165
600sg50	50	600sg110	110	600sg110	170
600sg55	55	600sg115	115	600sg115	175
600sg60	60	600sg120	120	600sg120	180
600sg65	65	600sg125	125		

Slogging Open Jaw Wrenches

special drop forged steel



Art. No.	size (mm)	Art. No.	size (mm)	Art. No.	size (mm)
610sg24	24	610sg70	70	610sg125	125
610sg27	27	610sg75	75	610sg130	130
610sg30	30	610sg80	80	610sg135	135
610sg32	32	610sg85	85	610sg140	140
610sg36	36	610sg90	90	610sg145	145
610sg41	41	610sg95	95	610sg150	150
610sg46	46	610sg100	100	610sg155	155
610sg50	50	610sg105	105	610sg160	160
610sg55	55	610sg110	110	610sg165	165
610sg60	60	610sg115	115	610sg170	170
610sg65	65	610sg120	120	610sg175	175
				610sg180	180

Socket Sets and Ratchets

WGB brand Socket Sets 1/2" drive

sockets made of chrome-vanadium steel
chromium-plated, in sheet steel box
24 pcs per set, consisting of:

sockets: 10, 11, 12, 13, 14, 15, 16, 17, 18, 19, 20,
21, 22, 23, 24, 27, 30, 32 mm

accessories:

- 352 (Universal Joint 73 mm)
- 356 (Extension 125 mm)
- 356 (Extension 250 mm)
- 354 (T-slide Handle 300 mm)
- 353 (Speeder)
- 3066 (Reversible Ratchet 255 mm - 72 teeth)



Further socket sets available on request e.g. 1/4", 3/8" drive

Reversible Ratchet

lever type, 72 teeth
made of chrome-vanadium steel, chrome plated
two component handle



Art. No.	square	teeth	length
5012003	1/4"	72	140
2356003	3/8"	72	190
3066003	1/2"	72	250

Reversible Ratchet

43, 41, 45 teeth
made of chrome-vanadium steel, chrome plated
two component handle



Art. No.	square	teeth	length
9291683	1/4"	43	140
9291693	3/8"	41	200
9291703	1/2"	45	250

Ratchets

Extension Bar

chrome-vanadium steel,
chrome plated



Art. No.	square drive	length (mm)
9208783	1/4"	55
9228713	1/4"	75
9208793	1/4"	105
9226143	1/4"	150
9224033	3/8"	50
9225923	3/8"	75
9224053	3/8"	125
9224043	3/8"	150
9224063	3/8"	250
9215133	3/4"	200
9215143	3/4"	400
9224693	1/2"	75
9200103	1/2"	125
9200113	1/2"	205

Universal Joint

chrome-vanadium steel,
chrome plated



Art. No.	square drive	length (mm)
2322003	3/8"	24
9201343	1/2"	36
9224923	3/4"	46

Sliding T-Handle

chrome-vanadium steel,
chrome plated



Art. No.	square drive	length (mm)
9208773	1/4"	115
9226913	3/8"	200
9200093	1/2"	300
9215153	3/4"	430

Sliding T-Handle

chrome-vanadium steel,
chrome plated



Art. No.	square drive	length (mm)
9208803	1/4"	40
9224073	3/8"	58
9200123	1/2"	73

Speeder Handle

chrome-vanadium steel,
chrome plated



Art. No.	square drive	length (mm)
9200083	1/2"	375

Torque Wrenches

PADRE brand torque wrench with reversible ratched-head

- 1/2", 3/8", 1/2", 3/4", chrome-vanadium steel
- double scale in N-m and lbf-ft divisions for precise adjustment
 - actuation accuracy: +/- 3% tolerance of the set scale value
 - large vision panel, precise adjustment using a magnifyingglass
 - an audible and palpable signal when desired torque value is achieved
 - with exact gearing 30-teeth ratchet mechanism
 - secure locking function within the handle
 - square drive adaptor to DIN 3120 ISO 1174 with ball lock
 - two-component handle with a soft zone, is ergonomic in design and comfortable in the hand



Art. No.	drive	NM	graduation (Nm)	lbf.ft	length (mm)	weight (grs)
1965	1/4"	2 - 25	0,1	1,5 - 18	289	460
1966	3/8"	5 - 50	0,25	3,5 - 37	350	610
1967	1/2"	10 - 100	0,5	8 - 75	412	910
1968	1/2"	20 - 200	1	10 - 150	500	1300
1969	1/2"	60 - 300	1	45 - 220	585	1450
1971	3/4"	100 - 600	1	75 - 440	960	3800
1972	3/4"	150 - 800	10	110 - 960	1250	4800
1973	3/4"	200 - 1000	30	150 - 740	1500	5800

PADRE brand torque wrench adaptor

Art. No.	size
909	1/4" to 3/8"
926	3/8" to 1/2"
962	1/2" to 3/4"
997	3/4" to 1"



Ratchets & Tools Assortment



PADRE brand Metal Tool Boxes, green, 5-tray

consisting of: 102 pcs tools assortment,
box with one handle and 1 brass padlock



Art. No. 1726 MM	size: 530 x 200 x 200 mm	all sizes mm
Art. No. 1726 AF	size: 530 x 200 x 200 mm	all sizes inch

PADRE brand Ratchets

1/2" drive, according to DIN 3122
chrome-vanadium steel, chrome plated



Art. No.	length (mm)	weight (g)	version
947	280	490	reversible type
948	280	490	push type

PADRE brand reversible Ratchets

1/2" drive, according to DIN 3122
chrome-vanadium steel, chrome plated



Art. No.	length (mm)	weight (g)	version
950H	250	490	lever type

PADRE brand Socket Set Wrenches - 25 pcs/set

1/2" drive, chrome-vanadium steel
metric, in metal case

Art. No. 978 HS

containing:

- | | | |
|----------------------|---|----------------|
| 1 Sliding T-Handle | No. 946 | length: 300 mm |
| 1 Reversible Ratchet | No. 950H | length: 250 mm |
| 1 Universal Joint | No. 955 | length: 65 mm |
| 1 Extension bar | 125/250 | |
| 20 Sockets | 10, 11, 12, 13, 14, 15, 16, 17, 18, 19, 20, 21, 22, 23, 24, 25, 26, 27, 30, 32 mm | |



Socket Sets

PADRE brand Socket Set Wrenches - 26 pcs/set

1/2" drive, chrome-vanadium steel
metric, in metal case

Art. No. 979 HS

containing:

- | | | |
|----------------------|---|----------------|
| 1 Speed braze | No. 945 | length: 410 mm |
| 1 Sliding T-Handle | No. 946 | length: 300 mm |
| 1 Reversible Ratchet | No. 950H | length: 250 mm |
| 1 Universal Joint | No. 955 | length: 65 mm |
| 1 Extension bar | 125/250 | |
| 20 Sockets | 10, 11, 12, 13, 14, 15, 16, 17,
18, 19, 20, 21, 22, 23, 24, 25,
26, 27, 30, 32 mm | |



PADRE brand Bit Socket Torx Set - 9 pcs/set

1/2" drive,
in metal case



Art. No.	contents
986 T 9	969/-T20-T25-T27-T30-T40-T45-T50-T55-T60

PADRE brand Bit Socket Hexagon Set - 9 pcs/set

1/2" drive, metric,
in metal case



Art. No.	contents
986 S 9	967/-4-5-6-7-8-10-12-14-17

PADRE brand Tubular box-spanners, nickel-plated



Art. No.	(mm)	length (mm)	Ø (mm)	Art. No.	(mm)	length (mm)	Ø (mm)
815	4x5	110	5,5	815	19x22	170	12,5
	6x7	110	5,5		19x24	180	12,5
	8x9	110	6,5		20x22	170	12,5
	8x10	120	6,5		21x23	170	14,5
	9x10	120	6,5		22x24	180	14,5
	9x11	120	6,5		22x27	180	14,5
	10x11	120	6,5		24x26	180	14,5
	10x13	140	6,5		24x27	180	14,5
	10x14	140	6,5		24x30	180	14,5
	11x13	140	6,5		25x28	180	16,3
	11x14	140	6,5		27x29	210	16,3
	12x13	140	8,5		27x30	210	16,3
	12x14	140	8,5		27x32	210	16,3
	13x14	140	8,5		30x32	210	16,3
	13x15	140	8,5		30x36	230	18,5
	13x17	150	10,0		32x36	230	18,5
	14x15	140	10,0		36x41	230	18,5
	14x17	150	10,0		41x46	250	21,0
	16x17	150	10,0		46x50	250	21,0
	17x19	160	12,5		50x55	280	21,0
	17x22	170	12,5		55x60	280	21,0
	18x19	160	12,5				

Rim Wrenches

Single Ended Wheel Nut Wrenches

for trucks, special tool steel, silver lacquered



Art. No.	size	length
72 3112 019	19 mm	265 mm
72 3112 022	22 mm	360 mm
72 3112 024	24 mm	360 mm
72 3112 027	27 mm	400 mm
72 3112 030	30 mm	400 mm
72 3112 032	32 mm	400 mm
72 3112 033	33 mm	400 mm
72 3112 036	36 mm	400 mm

Cross Wheel Wrenches

made from special tool steel, silver lacquered

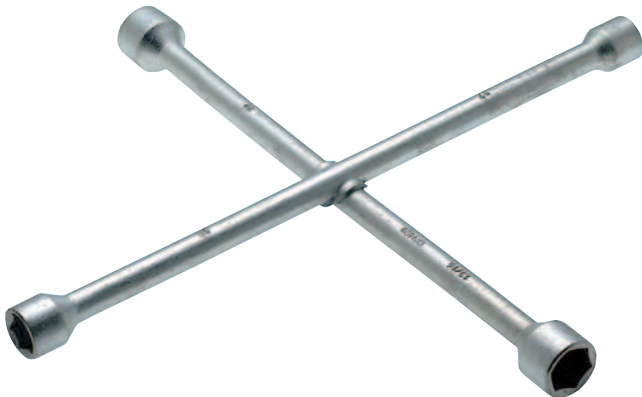

a) for trucks

24 x 27 x 38 x 32 mm (13/16")
15/16 x 1.1/16 x 1.1/2 x 1.1/4" (13/16")

Art. No. 70 2000 000

b) for trucks

19 x 22 x 24 x 27 mm
3/4 x 7/8 x 15/16 x 1.1/16" (13/16")

Art. No. 72 2000 000

c) for cars

17 x 19 x 22 mm x 1/2"

Art. No. 70 0150 800

a) for cars

17 x 19 x 22 mm x 13/16" (outside 4-point/square)

Art. No. 70 0100 000



Double Ended Wheel Nut Wrenches

for trucks, special tool steel, silver lacquered, length 400 mm



a) 6-point on both sides

Art. No.	length
70 5000 002	24 x 27 mm
70 5700 002	27 x 30 mm
70 5500 002	27 x 33 mm
70 5800 002	30 x 32 mm
70 5900 002	30 x 33 mm
70 9590 002	32 x 33 mm



b) 6-point / 6-point + 4-point / square drive (13/16")

Art. No.	length
70 3210 002	38 x 32 mm
70 3300 002	1.1/16 x 1.1/4"
70 3310 002	27 x 32 mm
70 3400 002	1.1/8 x 1.1/4"
70 3100 002	1.1/8" x 1.1/2"
70 3200 002	1.1/4" x 1.1/2"



c) 4-point / 6-point

Art. No.	length
70 1307 002	17 x 32 mm
70 1306 002	17 x 35 mm
70 1304 002	21 x 38 mm
70 1302 002	21 x 41 mm



Tommy Bars

fully hardened 18 x 500 mm, silver lacquered

Art. No. 70 3010 102



Tyre Levers & Pry Bars



Tyre Levers - Mounting Bars

forged and both ends heat treated



straight - type



s - type



knee - type



straight - type

Art. No.	length (mm)
----------	-------------

2101/1	150
2101/2	200
2101/3	300
2101/4	400
2101/5	500
2101/6	600
2101/7	700

s - type

Art. No.	length (mm)
----------	-------------

2104/3	300
2104/4	400
2104/5	500
2104/6	600
2104/7	700

knee - type

Art. No.	length (mm)
----------	-------------

2106/3	300
2106/4	400
2106/5	500
2106/6	600
2106/7	700

straight - type



knee - type



Mercedes Benz - type



Tyre Levers - HEYCO brand

forged and both ends heat treated



straight - type

length (mm)	Art. No.
-------------	----------

300	1500030080
400	1500040080
450	
500	1500050080
600	1500060080

knee - type

Art. No.

1505040080
1505050080
1505060080

Mercedes Benz - type

Art. No.	Ref. No.
----------	----------

1509045020	0005811758
1509060020	0005812158

rim assembling lever



rim dismantling lever



KISTENMACHER Tyre Levers - (TRILEX - type)

Art. No.	length (mm)	description
01 3400 700	500	rim assembling lever
01 3400 200	500	rim dismantling lever



Tyre Lever Sets - (TRILEX - type)

consisting of assembling & dismantling lever

Art. No.	size (mm)
313846020	600 x 20



6815



6810

Pry Bar Standard Ø 14 mm

Chrome-vanadium steel, silver painted

Art. No.	length (mm)	description
6815	400	round shaft
6810	400	square shaft

Pullers

Standard Pullers - No. 10 2-arm mechanical Type



pulling legs, drop forged, in one piece. therefore guaranteed non bending even by extremely hard work. for swift and safe removal of wheels of any description, gears, races, ball bearings, pulleys etc.

Art. No.	size (mm)	size (mm)
10/1	15-85	100
10/1A	15-125	100
10/2	20-160	150
10/2A	20-200	150
10/3	40-250	200
10/3A	40-350	200
10/4	40-530	200



Standard Pullers - No. 13 3-arm mechanical Type

strong triple grip puller with parallel movable legs. can be used for external and also for internal work by simply turning pulling legs. triple grip puller cannot tip over even by extreme use.

important notice: pulling legs, extensions and all other equipment of standard twin grip pullers can be used in conjunction with our No. 13 triple grip pullers.

Art. No.	size (mm)	size (mm)
13/1A	15-120	100
13/2	20-160	150
13/2A	20-220	150

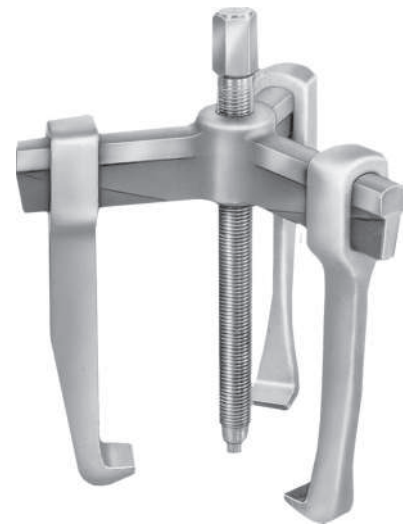

Universal Pullers - No. 16/17

strong universal triple grip puller with parallel movable legs and large spread. can be used for inside or outside operations. the triple grip puller cannot tip over even by extreme use.

2-arm mechanical type

Art. No.	size (mm)	size (mm)
16/1	25-80	100
16/1A	25-130	100
12/2	50-160	150
16/2A	60-200	150
16/3	80-250	200
16/3A	80-350	200
16/4	110-250	200
16/5	170-640	225

3-arm mechanical type

Art. No.	size (mm)	size (mm)
17/1	25-80	100
17/1A	25-120	100
17/2	50-160	150
17/2A	60-200	150
17/3A	100-380	200
17/4	120-250	200
17/5	120-640	200



Pullers



Universal Pullers - No. 20/21

strong universal triple grip puller with parallel movable legs and large spread. can be used for inside or outside operations. the triple grip puller cannot tip over even by extreme use.



2-arm mechanical type

3-arm mechanical type

Art. No.	size (mm)	size (mm)	Art. No.	size (mm)	size (mm)
20/1	20-150	80	21/1	20-150	80
20/2	40-200	130	21/2	40-200	130

Universal Pullers - No. 22/23

of sturdy yet well balanced construction for all types of application, simply to operate, very wide range. self-locking system prevents slipping of jaws. more pressure by forcing screw automatically increases grip of jaws. mechanical centre screws are interchangeable with hydraulic rams.



2-arm mechanical type

3-arm mechanical type

Art. No.	size (mm)	size (mm)	Art. No.	size (mm)	size (mm)
22/01	15-85	85	23/01	15-85	85
22/0	20-120	120	23/0	20-120	120
22/1	20-165	145	23/1	20-165	145
22/2	35-230	220	23/2	35-230	220
22/3	50-300	270	23/3	50-300	270
22/4	50-400	400	23/4	50-400	400
22/5	50-500	500	23/5	50-500	500
22/6	55-650	500	23/6	55-650	500

Universal Puller Sets - No. K22/60

this illustration shows separator with universal puller separating two closely placed gear wheels. they can then easily be pulled off from the shaft.

set consisting of each 1 pc in metal case:

Universal puller	No. 22/1, 22/2
Separators	No. 60/1, 60/2
Cross-beam	No. 23/1K, 23/2K
1 Pulling Leg, compl.	No. 22/1H, 22/2H

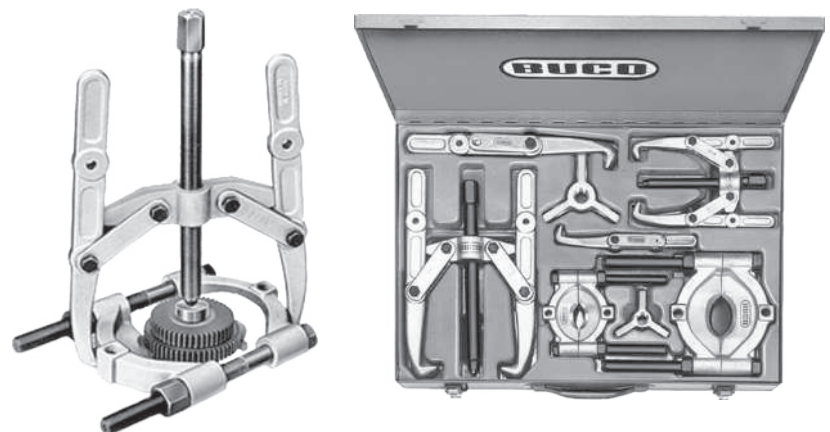

Pullers



Heavy Pullers - No. 24/25/26/27

mechanical type

exceptionally strong design combined with large capacity. universal use as pulling legs are interchangeable. a puller with 5 legs can easily be made into a 4-, 3- or 2-leg puller. in case of spoke wheels it is advisable to insert legs between spokes on the hub. our powerful hydraulic pullers are specially recommended for all industrial maintenance and repair work.



2-arm mechanical type

Art. No.	size (mm)	size (mm)
----------	-----------	-----------

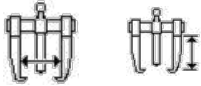

24/1	50-350	325
24/2	60-500	500

3-arm mechanical type

Art. No.	size (mm)	size (mm)
----------	-----------	-----------



25/1	60-350	325
25/2	60-500	500

4-arm mechanical type

Art. No.	size (mm)	size (mm)
----------	-----------	-----------

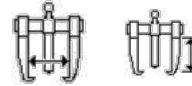

26/1	70-350	325
26/2	70-500	500

5-arm mechanical type

Art. No.	size (mm)	size (mm)
----------	-----------	-----------

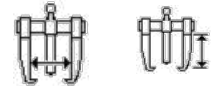

27/1	80-350	325
27/2	80-500	500

Universal Pullers - No. 36/37

a small very handy inexpensive puller designed for any light work. the unique self-locking device enables arms to be pressed tightly against parts to be pulled.

2-arm mechanical type

Art. No.	size (mm)	size (mm)
----------	-----------	-----------

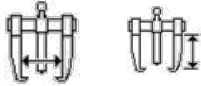

36/1	10-55	40
36/2	10-75	65

3-arm mechanical type

Art. No.	size (mm)	size (mm)
----------	-----------	-----------



37/1	10-55	40
37/2	10-75	65

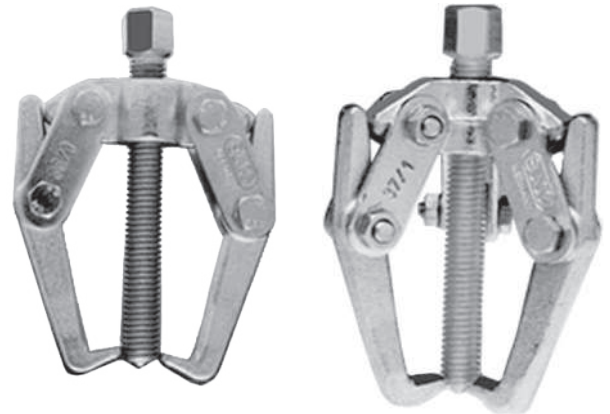

Battery Terminal Pullers - No. 40

a small very handy puller for battery service, electrical appliances, small motors, ball bearings, gears, etc. the ideal -one hand- application allows swift safe and easy use. automatic clamping of pulling legs by spring pressure. once in position no slipping-off possible.

2-arm mechanical type

Art. No.	size (mm)	size (mm)
----------	-----------	-----------



40/1	10-55	40
40/2	10-70	65



Pullers



Universal Pullers - No. 92/93

handy little pullers with self-centering function and automatically adjusting pulling legs. the higher the increasing pressure of the spindle, the firmer the clasping pressure of the pulling legs.

2-arm type

3-arm type

Art. No.	size (mm)	size (mm)	Art. No.	size (mm)	size (mm)
92/1	10-60	45	93/1	10-60	45
92/2	10-70	65	93/2	10-70	65
92/3	10-100	80	93/3	10-100	80



2-arm type



3-arm type

Universal Pullers - No. 94/95

handy little pullers with self-centering function and automatically adjusting pulling legs. the higher the increasing pressure of the spindle, the firmer the clasping pressure of the pulling legs.

2-arm type

3-arm type

Art. No.	size (mm)	size (mm)	Art. No.	size (mm)	size (mm)
94/1	10-100	80	95/1	10-100	80
94/2	10-120	120	95/2	10-120	120
94/3	20-160	160	95/3	20-160	160
94/4	20-220	200	95/4	20-220	200



2-arm type



3-arm type

Ball Joint Pullers - No. 180

for easy and swift removal of ball pins from the tapered housing on steering arms.



Art. No.	opening (mm)	width (mm)	height (mm)
180/2	18	37	37
180/3	23	45	45
180/4	29	55	60
180/5	39	70	80
180/6	46	90	100

Ball Joint Pullers - No. 183

very handy, many sided and specially suited for where lack of space forbids entry of direct models



Art. No.	opening (mm)	height (mm)
183/1	22	20-50

Pullers & Separators



Separators - No. 60

indispensable for the removal of races, bearings, gear wheels etc. from hubs, shafts, where space is limited. the flat sides of separator halves give ample all round support.

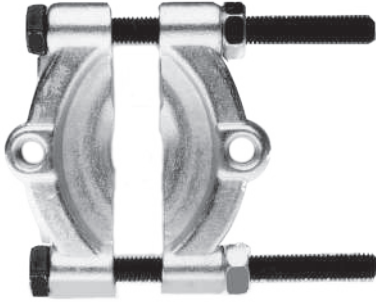

Art. No.	opening (mm)	for use with pulling units
60/0	5 - 60	B10/1 + B10/1A. 62/0
60/1	12 - 75	B10/1A. 62/1
60/2	22 - 150	B10/2 + B10/2A. 62/2
60/3	30 - 155	B10/3 + B10/3A. 62/3
60/4	30 - 200	B10/3A. 62/4
60/5	40 - 280	62/5

Pulling Units - No. B10

for separators and thread adaptors



Art. No.	width (mm)	length (mm)	for use with separators
B10/1	100	110	60/0
B10/1A	130	110	60/1
B10/2	165	185	60/2
B10/2A	205	185	60/2
B10/3	260	260	60/3
B10/3A	355	260	60/3 60/4
B10/4	530	260	60/3 60/4

Pulling Units - No. 62

for separators and thread adaptors



Art. No.	width (mm)	length (mm)	for use with separators
62/0	45 - 110	110	60/0
62/1	55 - 140	155	60/1
62/2	60 - 215	200	60/2
62/3	85 - 295	315	60/2
62/4	120 - 350	305	60/3 60/4
62/5	140 - 435	320	60/5

Sets: Separator No. 60 + Pulling Units - No. B10 mechanical type

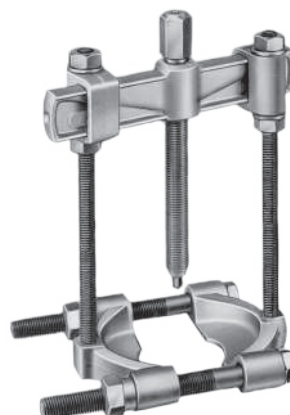

Art. No.	opening (mm)	width (mm)
60/0 + B10/1	5 - 60	100
60/1 + B10/1A	12 - 75	130
60/2 + B10/2	22 - 150	165
60/3 + B10/3	30 - 155	260
60/4 + B10/3A	30 - 200	530

Pullers & Separators



Puller sets

in metal case, consisting of:
pulling unit - extension (pair) - separator



Art. No.	contents
K60/0	B10/1 - 60/0 - ZBV/1
K60/1	B10/1A - 60/1 - ZBV/1
K60/2	B10/2 - 60/2 - ZBV/2
K60/3	B10/3 - 60/3 - ZBV/3
K60/4	B10/3A - 60/4 - ZBV/3

Art. No.	contents
K62/0	62/0 - 60/0 - ZBV/1
K62/1	62/1 - 60/1 - ZBV/1
K62/2	62/2 - 60/2 - ZBV/2
K62/3	62/3 - 60/3 - ZBV/3
K62/4	62/4 - 60/4 - ZBV/3



Coil Spring Compressor Sets

for quick and safe mounting or removal of all usual coils. the simple yet safe clamping device avoids the breaking away of the spring while working.

it is advisable to use 3 spring compressors simultaneously evenly placed. this will avoid sagging of spring.

long and short spindles are interchangeable.

Art. No.	size:
909/1 - 2 pcs	200 mm
909/2 - 2 pcs	300 mm
909/3 - 2 pcs	400 mm

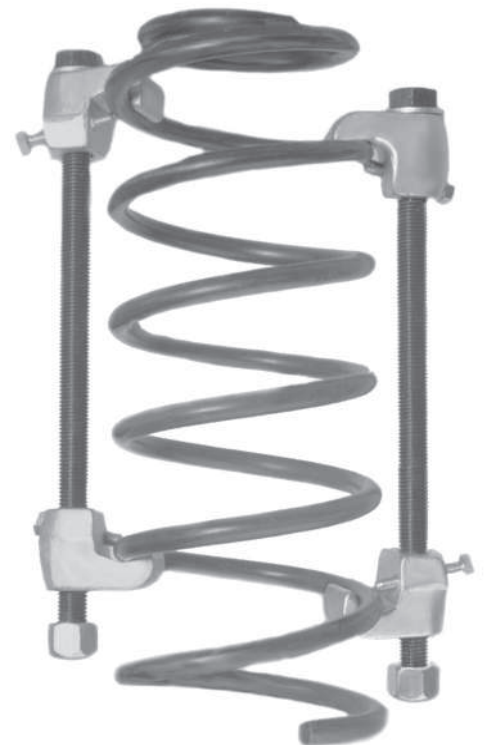

Hammers

Plastic Hammers with yellow or red transparent heads

made of shock proof cellulose-acetate,
ash wood handle



Art. No. red	Art. No. yellow	length (mm)	dia. (mm)	pcs/ carton
100/22	101/22	250	22	6
100/27	101/27	270	27	6
100/32	101/32	280	32	6
100/35	101/35	290	35	6
100/40	101/40	320	40	6
100/50	101/50	340	50	6
100/60	101/60	370	60	2

Nylon Hammers with white/milky heads

made of shock proof nylon,
ash wood handle



Art. No. white	length (mm)	dia. (mm)	pcs/ carton
102/22	250	22	6
102/27	270	27	6
102/32	280	32	6
102/35	290	35	6
102/40	320	40	6
102/50	340	50	6
102/60	370	60	2

Spare Heads for Plastic Hammers, yellow

made of shock proof cellulose-acetate (1 pair)



Art. No. yellow	dia. (mm)
1925/22	22
1925/27	27
1925/32	32
1925/35	35
1925/40	40
1925/50	50
1925/60	60

Spare Heads for Plastic Hammers, white/milky

made from nylon, (1 pair)



Art. No. yellow	dia. (mm)
1926/22	22
1926/27	27
1926/32	32
1926/35	35
1926/40	40
1926/50	50
1926/60	60

Rubber Mallets

with flat faces, ash wood handle



Art. No.	weight (g)	head size (mm)
571.1	160	80 x 40
571.2	340	90 x 54
571.3	550	110 x 65
571.4	750	127 x 75
571.5	1250	140 x 90

PICARD brand Cross Pein and Finishing Hammer

with extra wide and thin face



Art. No. 252/51

PICARD brand Cross Pein and Finishing Hammer

with extra wide and thin face, with straight pein



Art. No. 252/52

Bumping Tools



PICARD brand Bumping Tool Sets

9 pcs per set, in sheet iron boxes

Art. No. 0025200



PICARD brand Bumping Tool Sets

12 pcs per set, in sheet iron boxes

Art. No. 0025900



PICARD brand Bumping Tool Sets

25 pcs per set, in sheet iron boxes, 3 compartments

Art. No. 0026000



PICARD brand Bumping Tool Sets

30 pcs per set, in sheet iron boxes, 3 compartments

Art. No. 0025400



PICARD brand Inside Pry and Surfacing Spoon

small pattern

Art. No. 2521800



Art. No. 2521890



PICARD brand Inside Pry and Surfacing Spoon

Art. No. 2521990



PICARD brand Anvil Blocks

Art. No. 252/15 roof wedge



Art. No. 252/40 toe pattern



Grips

Grips with Wire Cutters

with drop-forged chrome-vanadium steel jaws, used for round and flat materials



Art. No.	length (mm)	weight (g)	capacity (mm)
0100-0105	140	170	30
0100-0107	180	355	35
0100-0110	250	545	50
0100-0112	300	900	65

also available with extra wide red PVC coated quick-release lever



Art. No.	length (mm)	weight (g)	capacity (mm)
0100-1111	250	550	50

Grips with Straight Drop-forged Jaws

of chrome-vanadium steel, used for flat materials



Art. No.	length (mm)	weight (g)	capacity (mm)
0200-0207	180	355	35
0200-0210	250	510	40

Ideal Grips

with drop-forged chrome-vanadium steel jaws, used for flat, round, shaped and square materials



Art. No.	length (mm)	weight (g)	capacity (mm)
0250-0251	180	370	35
0250-0252	250	575	50

Prisma Grips

with drop-forged chrome-vanadium steel jaws, used for round and flat materials



Art. No.	length (mm)	weight (g)	capacity (mm)
0110-0118	180	350	30
0110-0125	250	555	35
0110-0130	300	900	50

Grips

Parallel Plus Grips

with drop-forged chrome-vanadium steel jaws, used for round and flat materials



Art. No.	length (mm)	weight (g)	capacity (mm)
0150-0150	250	580	45

Parallel Grips

with drop-forged chrome-vanadium steel jaws, used for flat and shaped materials



Art. No.	length (mm)	weight (g)	capacity (mm)
0160-0160	250	700	50

Welding Grips with Jaws

of chrome-vanadium steel



Art. No.	length (mm)	weight (g)	capacity (mm)
0300-0300	280	790	60
0300-0301	280	935	70

Grips for Tubes with Jaws

of chrome-vanadium steel



Art. No.	length (mm)	weight (g)	capacity (mm)
0320-0320	280	790	10-90
0320-0321	280	935	10-90

Long-Nose-Grips for sheet metal

of chrome-vanadium steel, ideal for clamping, bending and crimping of thin and soft sheet metals



Art. No.	length (mm)	weight (g)	capacity (mm)
0370-0370	180	470	45

Grips

C-Clamp Grips

with drop-forged chrome-vanadium steel jaws



Art. No.	length (mm)	weight (g)	capacity (mm)
0340-0340	175	235	50
0340-0341	280	710	90
0340-0342	460	1080	235
0340-0343	610	1355	410

Parallel C-Clamp Grips

with movable jaws



Art. No.	length (mm)	weight (g)	capacity (mm)
0350-0351	280	780	90
0350-0352	460	1170	235
0350-0353	610	1415	410

Long Nose Grips

with drop-forged chrome-vanadium steel jaws, used for gripping in tapering spaces



Art. No.	length (mm)	weight (g)	capacity (mm)
0360-0360	165	180	40
0360-0361	240	380	55

Chain Grip Cutters - for steel, copper or PVC

with drop forged chrome-vanadium steel jaws, used for large and asymmetric workpieces



Art. No.	length (mm)	weight (g)	capacity (mm)
0280-0280	250	930	150

Strap & Filter Wrenches, Piston Ring Compressors



Strap Wrenches

bright nickel plated
with plastic coated handle,
with non-slip textile strap

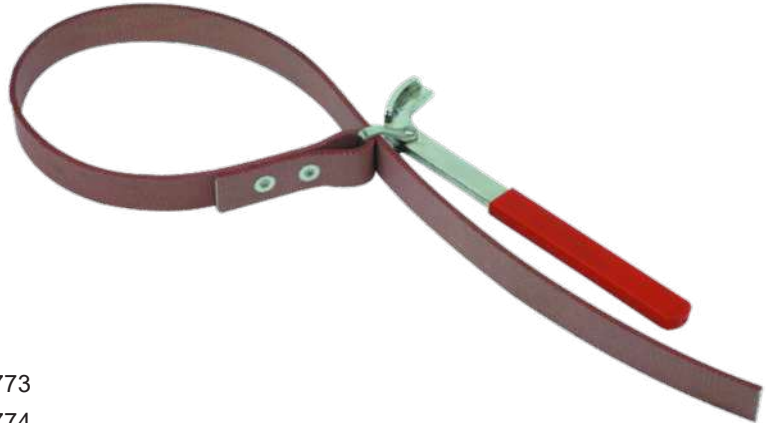

Art. No.	length (mm)	capacity (mm)
0740-0741	230	160
0740-0742	230	240

Replacement straps for 160 mm cap. Art. No. 0740-0773

Replacement straps for 240 mm cap. Art. No. 0740-0774

Strap Wrenches

chromium-plated with forged handle,
made of chrome-vanadium steel,
with non-slip textile strap



Art. No.	length (mm)	capacity (mm)
0740-0745	280	280

Replacement straps for 280 mm cap. Art. No. 0740-0746

Piston Ring Compressors

with infinitely variable regulation,
special spring steel, tightening
strap blue

Art. No.	length (mm)	capacity (mm)
0700-0701	80	57-125
0700-0711	100	57-125
0700-0702	80	90-175
0700-0721	100	90-175
0700-0703	165	90-175



Filter Wrenches & Valve Spring Compressors

Filter Wrenches

bright nickel plated
with plastic coated handle
with perforated strap



Art. No.	length (mm)	capacity (mm)
0760-0763	220	60-80
0760-0764	240	75-110

Filter Wrenches

bright nickel plated
with 1/2" square drive
with perforated strap



Art. No.	length (mm)	capacity (mm)
0760-0761	130	60-80
0760-0762	150	75-110

Filter Wrenches

bright nickel plated
with plastic coated handle
with toothed strap



Art. No.	length (mm)	capacity (mm)
0760-0773	210	60-80
0760-0774	230	75-110

Filter Wrenches

bright nickel plated
with 1/2" square drive
with toothed strap



Art. No.	length (mm)	capacity (mm)
0760-0771	140	65-80
0760-0772	160	75-110

Piston Ring Pliers

bright nickel plated, for removal and fitting
of piston rings

Art. No.	length (mm)	capacity (mm)
0600-0601	200	50-100
0600-0602	240	90-150



Valve Spring Compressors

bright nickel plated, for light vehicle engines

Art. No.	length (mm)	capacity (mm)	version
0500-0500	290	70-225	straight jaws

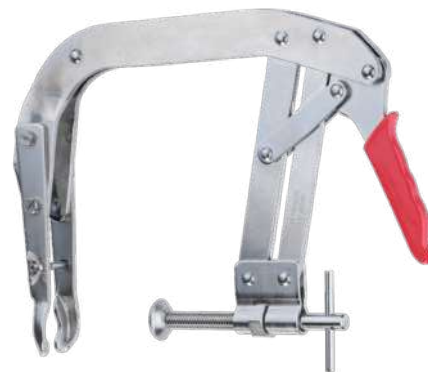

Replacement jaws, straight, pair Art. No. 0500-0511

Allen Keys

Hexagon Key Wrenches ISO 2936

chrome-vanadium steel - Type 200
available in black colour and nickel plated



metric size

inch size

Art. No. black	Art. No. nickel plated	Ø (mm)	Art. No. black	Art. No. nickel plated	Ø (inch)
200-015-01	200-015-02	1.5	200-364-51	200-364-52	3/64
200-020-01	200-020-02	2	200-005-51	200-005-52	0,05
200-025-01	200-025-02	2.5	200-116-51	200-116-52	1/16
200-030-01	200-030-02	3	200-564-51	200-564-52	5/64
200-035-01	200-035-02	3.5	200-332-51	200-332-52	3/32
200-040-01	200-040-02	4	200-764-51	200-764-52	7/64
200-045-01	200-045-02	4.5	200-180-51	200-180-52	1/8
200-050-01	200-050-02	5	200-964-51	200-964-52	9/64
200-055-01	200-055-02	5.5	200-532-51	200-532-52	5/32
200-060-01	200-060-02	6	200-316-51	200-316-52	3/16
200-070-01	200-070-02	7	200-732-51	200-732-52	7/32
200-080-01	200-080-02	8	200-140-51	200-140-52	1/4
200-090-01	200-090-02	9	200-932-51	200-932-52	9/32
200-100-01	200-100-02	10	200-516-51	200-516-52	5/16
200-110-01	200-110-02	11	200-113-51	200-113-52	11/32
200-120-01	200-120-02	12	200-380-51	200-380-52	3/8
200-130-01	200-130-02	13	200-716-51	200-716-52	7/16
200-140-01	200-140-02	14	200-120-51	200-120-52	1/2
200-150-01	200-150-02	15	200-916-51	200-916-52	9/16
200-160-01	200-160-02	16	200-580-51	200-580-52	5/8
200-170-01	200-170-02	17	200-340-51	200-340-52	3/4
200-180-01	200-180-02	18	200-780-51	200-780-52	7/8
200-190-01	200-190-02	19	200-100-51	200-100-52	1
200-200-01	200-200-02	20			
200-210-01	200-210-02	21			
200-220-01	200-220-02	22			
200-240-01	200-240-02	24			
200-270-01	200-270-02	27			
200-300-01	200-300-02	30			
200-320-01	200-320-02	32			
200-360-01	200-360-02	36			
200-400-01		40			
200-460-01		46			
200-500-01		50			
200-550-01		55			

Hexagon Key Wrenches ISO 2936L

EXTRA LONG chrome-vanadium steel - Type 210
available in black colour and nickel plated



metric size

inch size

Art. No. black	Art. No. nickel plated	Ø (mm)	Art. No. black	Art. No. nickel plated	Ø (inch)
210-015-01	210-015-02	1.5	210-364-51	210-364-52	3/64
210-020-01	210-020-02	2	210-005-51	210-005-52	0,05
210-025-01	210-025-02	2.5	210-116-51	210-116-52	1/16
210-030-01	210-030-02	3	210-564-51	210-564-52	5/64
210-035-01	210-035-02	3.5	210-332-51	210-332-52	3/32
210-040-01	210-040-02	4	210-764-51	210-764-52	7/64
210-045-01	210-045-02	4.5	210-180-51	210-180-52	1/8
210-050-01	210-050-02	5	210-964-51	210-964-52	9/64
210-055-01	210-055-02	5.5	210-532-51	210-532-52	5/32
210-060-01	210-060-02	6	210-316-51	210-316-52	3/16
210-070-01	210-070-02	7	210-732-51	210-732-52	7/32
210-080-01	210-080-02	8	210-140-51	210-140-52	1/4
210-090-01	210-090-02	9	210-932-51	210-932-52	9/32
210-100-01	210-100-02	10	210-516-51	210-516-52	5/16
210-110-01	210-110-02	11	210-113-51	210-113-52	11/32
210-120-01	210-120-02	12	210-380-51	210-380-52	3/8
210-130-01	210-130-02	13	210-716-51	210-716-52	7/16
210-140-01	210-140-02	14	210-120-51	210-120-52	1/2
210-150-01	210-150-02	15	210-916-51	210-916-52	9/16
210-160-01	210-160-02	16	210-580-51	210-580-52	5/8
210-170-01	210-170-02	17	210-340-51	210-340-52	3/4
210-180-01	210-180-02	18	210-780-51	210-780-52	7/8
210-190-01	210-190-02	19	210-100-51	210-100-52	1
210-200-01	210-200-02	20			
210-220-01	210-220-02	22			
210-240-01	210-240-02	24			
210-270-01	210-270-02	27			



Allen Key Sets

Hexagon Key Wrench Sets ISO 2936

chrome-vanadium steel - Type 230
each set packed in plastic wallet
available in black colour and nickel plated



metric size

Art. No. black	Art. No. nickel plated	pcs per set	sizes (mm)
230-186-01	230-186-02	8	1.5, 2, 2.5, 3, 4, 5, 5.5, 6
230-190-01S	230-190-02S	9	1.5, 2, 2.5, 3, 4, 5, 6, 8, 10
230-192-01	230-192-02	9	2, 2.5, 3, 4, 5, 6, 8, 10, 12
230-102-01S	230-102-02S	10	1.5, 2, 2.5, 3, 4, 5, 6, 8, 10, 12
230-102-01	230-102-02	10	2, 2.5, 3, 4, 5, 5.5, 6, 8, 10, 12
230-114-01	230-114-02	11	2, 2.5, 3, 4, 5, 5.5, 6, 8, 10, 12, 14

Hexagon Key Wrench Sets ISO 2936

chrome-vanadium steel - Type 230
each set packed in plastic wallet
available in black colour and nickel plated



inch size

Art. No. black	Art. No. nickel plated	pcs per set	sizes (inch)
230-284-51	230-284-52	8	1/16, 5/64, 3/32, 1/8, 5/32, 3/16, 7/32, 1/4
230-298-51S	230-298-52S	9	1/16, 5/64, 3/32, 1/8, 5/32, 3/16, 1/4, 5/16, 3/8
230-298-51	230-298-52	9	5/64, 3/32, 1/8, 5/32, 3/16, 7/32, 1/4, 5/16, 3/8
230-202-51S	230-202-52S	10	1/16, 5/64, 3/32, 1/8, 5/32, 3/16, 1/4, 5/16, 3/8, 1/2
230-202-51	230-202-52	10	5/64, 3/32, 1/8, 5/32, 3/16, 7/32, 1/4, 5/16, 3/8, 1/2
230-216-51	230-216-52	11	5/64, 3/32, 1/8, 5/32, 3/16, 7/32, 1/4, 5/16, 3/8, 1/2, 9/16

Hexagon Key Wrench Sets ISO 2936

chrome-vanadium steel - Type 238
each set packed in plastic clip
available in black colour and nickel plated



metric sizes

inch size



Art. No. black	Art. No. nickel plated	pcs per set	sizes (mm/inch)
238-376-01	238-376-02	7	1.5, 2, 2.5, 3, 4, 5, 6
238-390-01	238-390-02	9	1.5, 2, 2.5, 3, 4, 5, 6, 8, 10
238-302-01	238-302-02	10	1.5, 2, 2.5, 3, 4, 5, 6, 8, 10, 12
238-474-51	238-474-52	7	1/16, 5/64, 3/32, 1/8, 5/32, 3/16, 1/4
238-498-51	238-498-52	9	1/16, 5/64, 3/32, 1/8, 5/32, 3/16, 1/4, 5/16, 3/8
238-402-51	238-402-52	10	1/16, 5/64, 3/32, 1/8, 5/32, 3/16, 1/4, 5/16, 3/8, 1/2

Allen Key Sets

Hexagon Key Wrench Sets ISO 2936L

EXTRA LONG - chrome-vanadium steel - Type 213
each set packed in plastic wallet



metric sizes

Art. No. black	Art. No. nickel plated	pcs per set	sizes (mm)
213-188-01	213-188-02	8	1.5, 2, 2.5, 3, 4, 5, 6, 8
213-180-01	213-180-02	8	2, 2.5, 3, 4, 5, 6, 8, 10
213-190-01	213-190-02	9	1.5, 2, 2.5, 3, 4, 5, 6, 8, 10
213-192-01	213-192-02	9	2, 2.5, 3, 4, 5, 6, 8, 10, 12
213-102-01	213-102-02	10	1.5, 2, 2.5, 3, 4, 5, 6, 8, 10, 12



Hexagon Key Wrench Sets ISO 2936L

EXTRA LONG - chrome-vanadium steel - Type 213
each set packed in plastic wallet



inch sizes

Art. No. black	Art. No. nickel plated	pcs per set	sizes (inch)
213-286-51	213-286-52	8	1/16, 5/64, 3/32, 1/8, 5/32, 3/16, 1/4, 5/16
213-288-51	213-288-52	8	5/64, 3/32, 1/8, 5/32, 3/16, 1/4, 5/16, 3/8
213-298-51	213-298-52	9	1/16, 5/64, 3/32, 1/8, 5/32, 3/16, 1/4, 5/16, 3/8
213-292-51	213-292-52	9	5/64, 3/32, 1/8, 5/32, 3/16, 1/4, 5/16, 3/8, 1/2
213-202-51	213-202-52	10	1/16, 5/64, 3/32, 1/8, 5/32, 3/16, 1/4, 5/16, 3/8, 1/2



Hexagon Key Wrench Sets ISO 2936L

EXTRA LONG - chrome-vanadium steel - Type 211
each set packed in plastic clip



metric sizes

Art. No. black	Art. No. nickel plated	pcs per set	sizes (mm)
211-390-01	211-390-02	9	1.5, 2, 2.5, 3, 4, 5, 6, 8, 10
211-302-01	211-302-02	10	1.5, 2, 2.5, 3, 4, 5, 6, 8, 10, 12



inch sizes

Art. No. black	Art. No. nickel plated	pcs per set	sizes (inch)
211-498-51	211-498-52	9	1/16, 5/64, 3/32, 1/8, 5/32, 3/16, 1/4, 5/16, 3/8
211-402-51	211-402-52	10	1/16, 5/64, 3/32, 1/8, 5/32, 3/16, 1/4, 5/16, 3/8, 1/2



Allen Key Sets

Hexagon Key Wrenches with ballpoint

EXTRA LONG - chrome-vanadium steel - Type 413
each set packed in plastic wallet

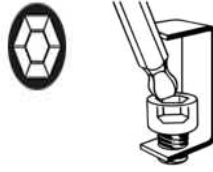

metric sizes

Art. No. nickel plated	Art. No. steel grey	pcs per set	sizes (mm)
413-166-02	413-166-08	6	2, 2.5, 3, 4, 5, 6
413-176-02	413-176-08	7	1.5, 2, 2.5, 3, 4, 5, 6
413-180-02	413-180-08	8	2, 2.5, 3, 4, 5, 6, 8, 10
413-190-02	413-190-08	9	1.5, 2, 2.5, 3, 4, 5, 6, 8, 10
413-102-02	413-102-08	10	1.5, 2, 2.5, 3, 4, 5, 6, 8, 10, 12



inch sizes

Art. No. nickel plated	Art. No. steel grey	pcs per set	sizes (inch)
413-274-52	413-274-58	7	5/64, 3/32, 1/8, 5/32, 3/16, 7/32, 1/4
413-298-52	413-298-58	9	5/64, 3/32, 1/8, 5/32, 3/16, 7/32, 1/4, 5/16, 3/8
413-202-52	413-202-58	10	1/16, 5/64, 3/32, 1/8, 5/32, 3/16, 1/4, 5/16, 3/8, 1/2



Hexagon Key Wrenches with ballpoint

LONG - chrome-vanadium steel - Type 451
each set packed in plastic clip



metric sizes

Art. No. nickel plated	Art. No. steel grey	pcs per set	sizes (mm)
451-365-02	451-365-08	6	1.5, 2, 2.5, 3, 4, 5
451-376-02	451-376-08	7	1.5, 2, 2.5, 3, 4, 5, 6
451-390-02	451-390-08	9	1.5, 2, 2.5, 3, 4, 5, 6, 8, 10
451-302-02	451-302-08	10	1.5, 2, 2.5, 3, 4, 5, 6, 8, 10, 12



inch sizes

Art. No. nickel plated	Art. No. steel grey	pcs per set	sizes (inch)
451-498-52	451-498-58	9	1/16, 5/64, 3/32, 1/8, 5/32, 3/16, 1/4, 5/16, 3/8
451-402-52	451-402-58	10	1/16, 5/64, 3/32, 1/8, 5/32, 3/16, 1/4, 5/16, 3/8, 1/2



Allen Key Sets



TORX Key Wrenches

chrome-vanadium steel - Type 525
each set packed in plastic wallet



Art. No. nickel plated	Art. No. steel grey	pcs per set	sizes (TX)
525-180-02	525-180-08	8	TX 9, 10, 15, 20, 25, 27, 30, 40

TORX Key Wrenches

EXTRA LONG - chrome vanadium steel - Type 551
each set packed in plastic clip



Art. No. steel grey	pcs per set	sizes (TX)
551-180-08	8	TX 9, 10, 15, 20, 25, 27, 30, 40
551-190-08	9	TX 10, 15, 20, 25, 27, 30, 40, 45, 50

KISTENMACHER brand - Hand Clip Allen Key Set

chrome-vanadium steel, black finish
nickel plated, metal hand clip

Art. No.	pcs per set	sizes (TX)
2937-45/7210	7	2.5, 3, 4, 5, 6, 8, 10 mm
2937-45/7211	7	1/16, 5/64, 3/32, 1/8, 5/32, 3/16, 7/32"
2937-45/7220	8	TX 9, 10, 15, 20, 25, 27, 30, 40
2937-45/7221	8	TX 9, 10, 15, 20, 25, 27, 30, 40 - tamper proof



Allen Key Sets & Offset Screwdrivers



KISTENMACHER brand Allen Key Set

chrome-vanadium steel, nickel plated, each set packed in PVC box packing (red/black Flexbox)

Art. No.	pcs per set	version	sizes
43KL/5KM	9	short type	1.5, 2, 2.5, 3, 4, 5, 6, 8, 10 mm
43KL/7KM	9	long type	1.5, 2, 2.5, 3, 4, 5, 6, 8, 10 mm
43KL/8KM	9	long type, ballpoint	1.5, 2, 2.5, 3, 4, 5, 6, 8, 10 mm
43KL/10KM	9	short type	TX 8, 9, 10, 15, 20, 25, 27, 30, 40
43/KL/11KM	9	short type	TX 9, 10, 15, 20, 25, 27, 30, 40, 45
43/KL/16KM	9	short type, ballpoint	TX 8, 9, 10, 15, 20, 25, 27, 30, 40



Offset Screwdrivers, DIN 5200

for slotted head screws, chrome-vanadium steel, nickel plated

Art. No.	length (mm)	width of blade (mm)	Ø shaft (mm)
	100	4,0	4,0
KMR03208	100	5,0	5,0
KMR03103	125	5,5	5,0
KMR03209	125	6,0	6,0
KMR03104	150	8,0	7,0



Offset Screwdrivers, DIN 5208

for cross recess screws, chrome-vanadium steel, nickel plated

Art. No.	length (mm)	Ø shaft (mm)	version
KMR03401	100	6,0	PH1 + PH2
KMR03501	100	6,0	6,0 + PH2
KMR03402	150	8,0	PH3 + PH4



Offset Screwdrivers, DIN 5208

for Pozidriv/Supadriv screws, chrome-vanadium steel, nickel plated

Art. No.	length (mm)	Ø shaft (mm)	version
KMR04021	100	6,0	PZ1 + PZ2
KMR04022	150	8,0	PZ3 + PZ4



Hexagon Key Wrenches - ergonomic T-Handle



Hexagon Key Wrenches - ergonomic T-handle

blade chrome-vanadium steel - nickel plated

Art. No.	Ø (mm)	length of blade (mm)	total length (mm)
220-220-02	2	200	225
220-252-02	2,5	200	225
220-315-02	3	150	175
220-320-02	3	200	225
220-415-02	4	150	175
220-420-02	4	200	225
220-515-02	5	150	182
220-520-02	5	200	232
220-615-02	6	150	182
220-620-02	6	200	232
220-720-02	7	200	232
220-815-02	8	150	182
220-820-02	8	200	232
220-102-02	10	200	239
220-122-02	12	200	239
220-143-02	14	300	339

Art. No.	Ø (mm)	length of blade (mm)	total length (mm)
220-564-52	5/64	100	125
220-332-52	3/32	100	125
220-180-52	1/8	150	175
220-532-52	5/32	150	175
220-316-52	3/16	150	182
220-140-52	1/4	150	182
220-516-52	5/16	150	182
220-380-52	3/8	200	239



Hexagon Key Wrenches - two component ergonomic T-handle with use of either end (side drive)

blade chrome-vanadium steel

Art. No.	Ø (mm)	length of blade (mm)	total length (mm)
226-020-07	2	125	151
226-025-07	2,5	125	151
226-030-07	3	125	151
226-040-07	4	125	151
226-050-07	5	150	184
226-060-07	6	150	184
226-080-07	8	175	218
226-100-07	10	175	218



T-Line Wrenches

T-Line, hexagon wrench, ball point, chrome-vanadium steel with multicomponent handle, with side drive

Art. No.	size	PU
54720	SW 2.0 x 100	12
54721	SW 2.5 x 100	12
54722	SW 3.0 x 100	12
54723	SW 4.0 x 150	12
54724	SW 5.0 x 150	12
54725	SW 6.0 x 200	12
54726	SW 8.0 x 200	12
54727	SW 10.0 x 200	12



T-Line, hexagon wrench, chrome-vanadium steel with multicomponent handle, with side drive

Art. No.	size	PU
54730	SW 2.0 x 100	12
54731	SW 2.5 x 100	12
54732	SW 3.0 x 100	12
54733	SW 4.0 x 150	12
54734	SW 5.0 x 150	12
54735	SW 6.0 x 200	12
54736	SW 8.0 x 200	12
54737	SW 10.0 x 200	12

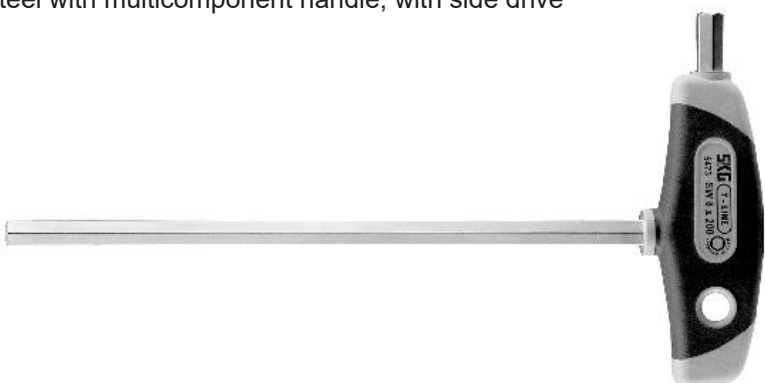

T-Line, torx wrench, chrome-vanadium steel with multicomponent handle, with side drive

Art. No.	size	PU	Art. No.	size	PU
54960	T 9 x 100	12			
54961	T 10 x 100	12	54973	T 10 x 200	12
54962	T 15 x 100	12	54974	T 15 x 200	12
54963	T 20 x 100	12	54975	T 20 x 200	12
54964	T 25 x 100	12	54976	T 25 x 200	12
54965	T 27 x 150	12	54977	T 27 x 200	12
54966	T 30 x 150	12	54978	T 30 x 200	12
54967	T 40 x 150	12	54970	T 40 x 200	12
54968	T 45 x 150	12	54971	T 45 x 250	12
54969	T 50 x 150	12	54972	T 50 x 250	12

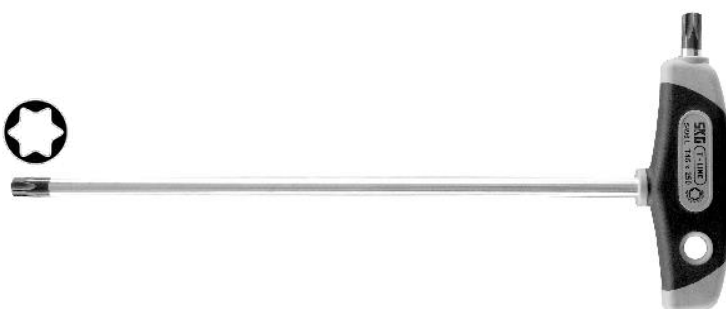

T-Line, socket wrench, chrome-vanadium steel with multicomponent handle

Art. No.	size	PU	Art. No.	size	PU
54900	SW 5.5 x 125	12			
54901	SW 6.0 x 125	12			
54902	SW 7.0 x 125	12	54920	SW 7.0 x 350	12
54903	SW 8.0 x 125	12	54921	SW 8.0 x 350	12
54904	SW 9.0 x 125	12	54922	SW 9.0 x 350	12
54905	SW 10.0 x 125	12	54923	SW 10.0 x 350	12
54906	SW 11.0 x 125	12	54924	SW 11.0 x 350	12
54907	SW 12.0 x 125	12	54925	SW 12.0 x 350	12
54908	SW 13.0 x 125	12	54926	SW 13.0 x 350	12
54909	SW 14.0 x 125	12	54927	SW 14.0 x 350	12
54917	SW 17.0 x 125	12	54928	SW 17.0 x 350	12



Screwdrivers



Screwdrivers Profi Comfort Line

blade chrome plated, with black tip, multicomponent handle, blue/black, 12 pcs per carton

Art. No.	Art. No.	mm
	66450	2.5 x 75
66010	66451	3.0 x 75
	66060	3.0 x 250
66011	66452	4.0 x 100
	66063	4.5 x 250
66012		5.0 x 100
	66453	5.0 x 150
	66454	5.0 x 200
66013		5.5 x 125
	66064	5.5 x 300
66014		6.0 x 125
	66065	6.0 x 450
66015	66066	6.5 x 150
66016		7.0 x 150
66017		8.0 x 175
66018		10.0 x 200
66029		12.0 x 250
66030		14.0 x 250

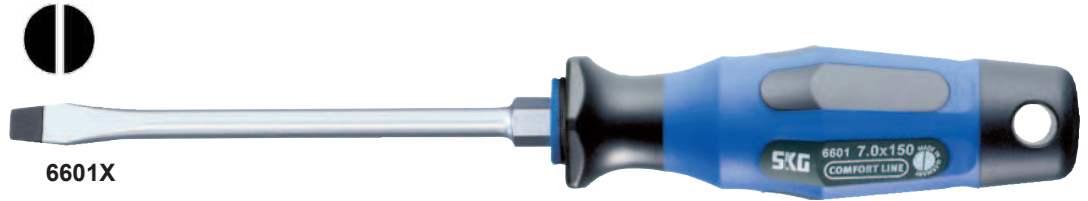

6601X

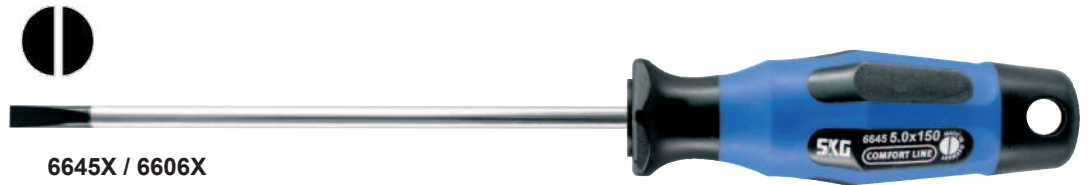

6645X / 6606X

Screwdrivers Profi Comfort Line

blade chrome plated, with black tip, multicomponent handle, blue/black, 12 pcs per carton

Art. No.	PH	mm
66350	0	60
66351	1	80
66352	2	100
66353	3	150
66047	4	200
33035	1	200
66036	1	300
66038	2	200
66039	2	300
66040	2	400
66046	3	300



6635X

Art. No.	PZ	mm
66370	0	60
66371	1	80
66372	2	100
66373	3	150
66057	4	200
66050	1	200
66051	1	300
66053	2	200
66054	2	300
66055	2	400
66056	3	300



6637X / 6605X

Screwdrivers

SKG



Nutdrivers Profi Comfort Line,

blade chrome plated, multicomponent handle, blue/black, 12 pcs per carton

Art. No.	size	Art. No.	size
66930	3.0 x 125	66941	11.0 x 125
66931	3.5 x 125	66942	12.0 x 125
66932	4.0 x 125	66943	13.0 x 125
66933	4.5 x 125	66944	14.0 x 125
66934	5.0 x 125	66945	15.0 x 125
66935	5.5 x 125	66946	16.0 x 125
66936	6.0 x 125	66947	17.0 x 125
66937	7.0 x 125	66921	1/4" x 125
66938	8.0 x 125	66922	5/16" x 125
66939	9.0 x 125	66923	3/8" x 125
66940	10.0 x 125	66924	1/2" x 125



Torx-Screwdrivers Profi Comfort Line,

blade chrome plated with black tip, multicomponent handle, blue/black, 12 pcs per carton

Art. No.	size	Art. No.	size
66973	T 5 x 50	66956	T 20 x 100
66950	T 6 x 50	66957	T 25 x 100
66951	T 7 x 50	66958	T 27 x 100
66952	T 8 x 60	66959	T 30 x 115
66953	T 9 x 60	66960	T 40 x 130
66954	T 10 x 80	66961	T 45 x 130
66955	T 15 x 80	66962	T 50 x 150



Ball Point Screwdrivers Profi Comfort Line,

blade chrome plated, with black tip, multicomponent handle, blue/black, 12 pcs per carton

Art. No.	size
66700	2.0 x 100
66701	2.5 x 100
66702	3.0 x 100
66703	4.0 x 100
66704	5.0 x 100
66705	6.0 x 125
66706	8.0 x 150
66707	10.0 x 150
66708	12.0 x 150



Screwdrivers



Screwdrivers Profi Basic-Line VDE - 1000 V

red insulated blade, with black tip, basic plastic handle, up to 1000V AC, GS approved, 12 pcs per carton

Art. No.	size	
63600	PH 0 x 60	
63601	PH 1 x 80	
63602	PH 2 x 100	
63603	PH 3 x 150	
63604	PH 4 x 200	

Art. No.	size	
63800	PZ 0 x 60	
63801	PZ 1 x 80	
63802	PZ 2 x 100	
63803	PZ 3 x 150	
63804	PZ 4 x 200	

Art. No.	size	
64700	2,5 x 75	
64701	3,0 x 75	
64702	3,0 x 100	
64703	3,5 x 100	
64704	4,0 x 100	
64705	5,5 x 100	
64706	6,5 x 100	
64707	8,0 x 175	
64708	10,0 x 200	

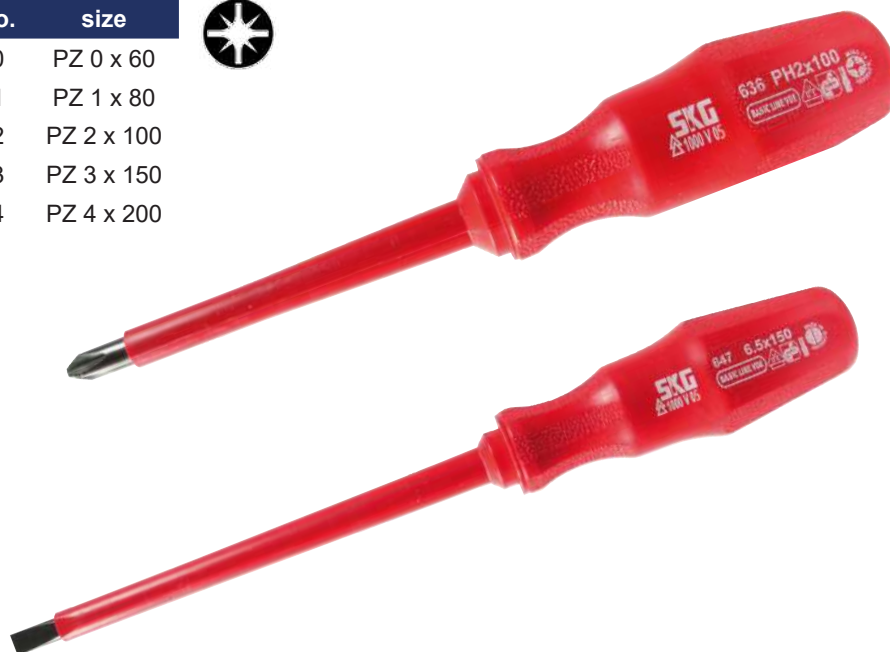

Screwdrivers Profi Comfort-Line VDE - 1000 V

red insulated blade, with black tip, multicomponent handle, red/yellow up to 1000V AC, GS approved, 12 pcs per carton

Art. No.	size	
66360	PH 0 x 60	
66361	PH 1 x 80	
66362	PH 2 x 100	
66363	PH 3 x 150	
66364	PH 4 x 200	

Art. No.	size	
66380	PZ 0 x 60	
66381	PZ 1 x 80	
66382	PZ 2 x 100	
66383	PZ 3 x 150	
66384	PZ 4 x 200	

Art. No.	size	
66470	2,5 x 75	
66471	3,0 x 75	
66472	3,0 x 100	
66473	3,5 x 100	
66474	4,0 x 100	
66475	5,5 x 100	
66476	6,5 x 100	
66477	8,0 x 175	
66478	10,0 x 200	



Screwdrivers



TORX Screwdrivers Profi Comfort-Line VDE - 1000 V

red insulated blade, with black tip, multicomponent handle, red/yellow, up to 1000V AC, GS approved, 12 pcs per carton

Art. No.	size	Art. No.	size
66982	T5 x 60	66989	T20 x 80
66983	T6 x 60	66990	T25 x 80
66984	T7 x 60	66991	T27 x 100
66985	T8 x 60	66992	T30 x 100
66986	T9 x 80	66993	T40 x 100
66987	T10 x 80	66994	T45 x 150
66988	T15 x 80		



Socket Wrench Profi Comfort-Line VDE - 1000V

red insulated blade, multicomponent handle, red/yellow, up to 1000V AC, GS approved, 12 pcs per carton

Art. No.	size	Art. No.	size
66900	4.0 x 125	66908	10.0 x 125
66901	4.5 x 125	66909	11.0 x 125
66902	5.0 x 125	66910	12.0 x 125
66903	5.5 x 125	66911	13.0 x 125
66904	6.0 x 125	66912	14.0 x 125
66905	7.0 x 125	66913	15.0 x 125
66906	8.0 x 125	66914	16.0 x 125
66907	9.0 x 125	66915	17.0 x 125



SET Profi Comfort-Line VDE All in One - Display Set

use one screwdriver for six sizes, red insulated blade, with black tip, multicomponent handle, red/yellow insulated up to 1000V AC,

GS approved, approved, 36 pcs/box

ALL-IN-ONE 1 SCREWDRIVER for 6 SIZES

Art. No.	size
SET 01500	PH/PZ 1-2-3 (6 sizes)



Screwdrivers



Profi Comfort-Line VDE - All in One - 1000 V

red insulated blade, with black tip, multicomponent handle, red/yellow, up to 1000V AC, GS approved, 12 pcs per carton

Art. No.	size
01500	PH/PZ 1-2-3 (6 sizes)



Profi Silver-Line - All in One

chrome-vanadium steel, multicomponent handle, with hex nut shank support, 12 pcs per carton

Art. No.	size
67150	PH/PZ 1-2-3 (6 sizes)



Profi Comfort-Line VDE All In One in blisterpacking

red insulated blade, with black tip, multicomponent handle red/yellow up to 1000V AC, GS approved



Art. No.	size
01501	PH/PZ 1-2-3

Profi Silver-Line - All in One in blisterpacking

chrome-vanadium steel, multicomponent handle with hex nut shank support



Art. No.	size
01502	PH/PZ 1-2-3

Screwdriver Sets

SKG



Profi Basic-Line Set - 6 pcs set

chrome plated blade, with black tip,
basic plastic handle, black, 12 sets per carton

Art. No. 56060

- 4.0 x 75 mm
- 5.0 x 100 mm
- 6.0 x 125 mm
- 7.0 x 150 mm

- ⊕ PH1 x 80 mm
- ⊕ PH2 x 100 mm

Art. No. 56070

with hex nut shank support

- 4.0 x 75 mm
- 4.5 x 95 mm
- 5.5 x 100 mm
- 7.0 x 125 mm

- ⊕ PH1 x 80 mm
- ⊕ PH2 x 100 mm



Profi Comfort-Line Set - 6 pcs set

chrome plated blade, with black tip,
multicomponent handle, blue/black, 12 sets per carton

Art. No. 65602

- 4.0 x 75 mm
- 5.0 x 100 mm
- 6.0 x 125 mm
- 7.0 x 150 mm

- ⊕ PH1 x 80 mm
- ⊕ PH2 x 100 mm

Art. No. 56612

with hex nut shank support

- 4.0 x 75 mm
- 4.5 x 95 mm
- 5.5 x 100 mm
- 7.0 x 125 mm

- ⊕ PH1 x 80 mm
- ⊕ PH2 x 100 mm



Profi Basic-Line Set VDE - 7 pcs set

red insulated blade, with black tip, basic plastic handle,
up to 1000V AC, 12 sets per carton

GS approved

Art. No. 56080

- 2.5 x 75 mm
- 4.0 x 100 mm
- 5.5 x 125 mm
- 6.5 x 150 mm

- ⊕ PH1 x 80 mm
- ⊕ PH2 x 100 mm

- voltage tester -140 mm



Profi Comfort-Line Set VDE - 7 pcs set

red insulated blade, with black tip, multicomponent
red/yellow handle, up to 1000V AC, 12 sets per carton

GS approved

Art. No. 65604

- 2.5 x 75 mm
- 4.0 x 100 mm
- 5.5 x 125 mm
- 6.5 x 150 mm

- ⊕ PH1 x 80 mm
- ⊕ PH2 x 100 mm

- voltage tester -140 mm



Screwdriver Sets

SKG



Profi Comfort-Line Set TORX-TR - 6 pcs per set

chrome plated blade, with black tip, multicomponent handle blue/black - tamper proof

Art. No. 65616 
T10, T15, T20, T25, T27, T30



Profi Comfort-Line Set TORX-TR - 7 pcs per set

chrome plated blade, with black tip, multicomponent handle blue/black - tamper proof

Art. No. 65615 
T9, T10, T15, T20, T25, T27, T30



Profi Comfort-Line Set TORX - 7 pcs per set

chrome plated blade, with black tip, multicomponent handle, blue/black

Art. No. 65617 
T10, T15, T20, T25, T27, T30, T40



Profi Comfort-Line Set TORX - 8 pcs per set

chrome plated blade, with black tip, multicomponent handle blue/black

Art. No. 65613 
T9, T10, T15, T20, T25, T27, T30, T40



Screwdriver Sets



KISTENMACHER brand Screwdriver set VDE/GS,
with one component handle, with red insulated blade
- red PPC/VDE execution

Art. No. 926/VDE

7 pcs set

- 2.5 x 75 mm
- 4.0 x 100 mm
- 5.5 x 125 mm
- 6.5 x 150 mm
- ⊕ PH1 x 80 mm
- ⊕ PH2 x 100 mm
- voltage tester - 140 mm



Art. No. 927/VDE

7 pcs set

- 2.5 x 75 mm
- 3.5 x 100 mm
- 4.0 x 100 mm
- 5.5 x 125 mm
- ⊕ PH1 x 80 mm
- ⊕ PH2 x 100 mm
- voltage tester - 140 mm

KISTENMACHER brand Screwdriver set VDE/GS,
with one component handle, with red insulated blade
- red PPC execution

Art. No. 926/VDE6

6 pcs set

- 2.5 x 75 mm
- 4.0 x 100 mm
- 5.5 x 125 mm
- ⊕ PH1 x 80 mm
- ⊕ PH2 x 100 mm
- voltage tester - 140 mm



Art. No. 926/VDE5

5 pcs set

- 3.0 x 100 mm
- 3.5 x 100 mm
- 4.0 x 100 mm
- ⊕ PH1 x 80 mm
- ⊕ PH2 x 100 mm

KISTENMACHER brand Screwdriver set,
with one component handle, nickel plated blade,
polished - red PPC execution

Art. No. 925/WS

7 pcs set

- 2.5 x 75 mm
- 4.0 x 100 mm
- 5.5 x 125 mm
- 6.5 x 150 mm
- ⊕ PH0 x 60 mm
- ⊕ PH1 x 80 mm
- ⊕ PH2 x 100 mm



Nutdriver & Bits



KISTENMACHER brand Socket Wrench / Nut Driver

with nickel plated chrome-vanadium blade and red transparent handle
Type: „Optiform“



Art. No.	size (mm)	Art. No.	size (mm)
3790/3	3.0	3790/9	9.0
3790/4	4.0	3790/10	10.0
3790/4,5	4.5	3790/11	11.0
3790/5	5	3790/12	12.0
3790/5,5	5.5	3790/13	13.0
3790/6	6	3790/14	14.0
3790/7	7	3790/17	17.0
3790/8	8		

Art. No.	size (inch)
3790/1/2	1/2
3790/3/8	3/8
3790/3/16	3/16
3790/7/32	7/32
3790/1/4	1/4
3790/5/32	5/32
3790/5/16	5/16
3790/1/8	1/8

Philips (PH) Bit

C 6,3 - 1/4" Hexagon, high quality chrome-vanadium steel



Art. No.	size (mm)	length (mm)
142201025	1	25
142201050	1	50
142201070	1	70
142201090	1	90
142202025	2	25
142202050	2	50
142202070	2	70
142202090	2	90
142203025	3	25
142203050	3	50
142203070	3	70
142203090	3	90
142204032	4	32

Pozidriv (PZ) Bit

C 6,3 - 1/4" Hexagon, high quality chrome-vanadium steel



Art. No.	size (mm)	length (mm)
142301025	1	25
142301050	1	50
142301070	1	70
142301090	1	90
142302025	2	25
142302050	2	50
142302070	2	70
142302090	2	90
142303025	3	25
142303050	3	50
142303070	3	70
142303090	3	90
142304032	4	32

TORX (TX) Bit

C 6,3 - 1/4" Hexagon, high quality chrome-vanadium steel

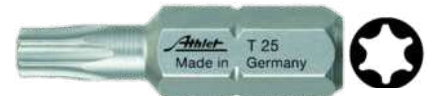

Art. No.	size (TX)	length (mm)
1445/WU/5/10	5	25
1445/WU/6/10	6	25
1445/WU/7/10	7	25
1445/WU/8/10	8	25
1445/WU/9/10	9	25
1445/WU/10/10	10	25
1445/WU/15/10	15	25
1445/WU/20/10	20	25
1445/WU/25/10	25	25
1445/WU/27/10	27	25
1445/WU/30/10	30	25
1445/WU/40/10	40	25
1445/WU/45/10	50	25
1445/WU/55/10	55	25

Slotted Bit

C 6,3 - 1/4" Hexagon, high quality chrome vanadium steel



Art. No.	size (mm)	length (mm)
142103025	3.0	25
142103525	3.5	25
142104025	4.0	25
142105525	5.5	25
142106525	6.5	25
142108025	8.0	25



Screwdriver Bits

Profi Double-sided Screwdriver Bit

high quality chrome-vanadium steel - 1/4"
Philips (PH) on both sides - 65 mm



packing options	qty
in plastic box	10/12
in plastic box	50/60
in sales carton	100/120
bulk packing	500/2500/5000

Profi Double-sided Screwdriver Bit

high quality chrome-vanadium steel - 1/4"
Philips (PH) and slotted Screws - 60 mm



packing options	qty
in plastic box	10/12
in plastic box	50/60
in sales carton	100/120
bulk packing	500/2500/5000

Profi Double-sided Screwdriver Bit

high quality chrome-vanadium steel - 1/4"
Pozidriv (PZ) on both sides - 65 mm



packing options	qty
in plastic box	10/12
in plastic box	50/60
in sales carton	100/120
bulk packing	500/2500/5000

Profi Double-sided Screwdriver Bit

high quality chrome-vanadium steel - 1/4"
Pozidriv (PZ) and slotted Screws - 60 mm



packing options	qty
in plastic box	10/12
in plastic box	50/60
in sales carton	100/120
bulk packing	500/2500/5000

Many other versions available upon request. Please contact our sales staff for further information!

Profi Long Screwdriver Bit

high quality chrome-vanadium steel - 1/4"
Philips (PH) DIN 3126 - E 6,3



Art. No.	size (mm)	length (mm)	packing options	qty
14320150	1	50	in plastic box	10/12
14320170	1	70	in plastic box	50/60
14320189	1	89	in sales carton	100/120
14320250	2	50	bulk packing	500/2500/5000
14320270	2	70		
14320289	2	89		
14320350	3	50		
14320370	3	70		
14320389	3	89		

Profi Long Screwdriver Bit

high quality chrome-vanadium steel - 1/4"
Slotted DIN 3126 - E 6,3



Art. No.	size (mm)	size (mm)	length (mm)	packing options	qty
1431053050	0,5	3,0	50	in plastic box	10/12
1431053070	0,5	3,0	70	in plastic box	50/60
1431063550	0,6	3,5	50	in sales carton	100/120
1431084550	0,8	4,5	50	bulk packing	500/2500/5000
1431105550	1,0	5,5	50		
1431126550	1,2	6,5	50		
1431168050	1,6	8,0	50		

Many other versions available upon request. Please contact our sales staff for further information!

Screwdriver Bits

Profi long Screwdriver Bit

high quality chrome-vanadium steel
TORX (TX) - 1/4" Drive DIN 3126 - E 6,3 - 50 mm



packing options	qty
in plastic box	10/12
in plastic box	50/60
in sales carton	100/120
bulk packing	500/2500/5000

Profi long Screwdriver Bit

high quality chrome-vanadium steel
Hexagonal - 1/4" Drive DIN 3126 - E 6,3 - 50 mm



packing options	qty
in plastic box	10/12
in plastic box	50/60
in sales carton	100/120
bulk packing	500/2500/5000

Double Sided Screwdriver Bit

high quality chrome-vanadium steel - 1/4"
red metallic lacquered, packing in transparent plastic box

available in various colours

Art. No.	size	colour	packing
141202065-R/12	PH2 + PH2 65 mm	red metallic	12/box
141202065-R/20	PH2 + PH2 65 mm	red metallic	20/box



Magnetic Bit holder DIN 3126

with strong permanent magnet, with stainless steel sleeve
packed in plastic box



Art. No.	size	st. steel sleeve	circlip
14300054100/50	50 mm E 6.3	10,0 x 25 mm	w/o
14300104100/50	100 mm E 6.3	10,0 x 35 mm	w/o
14300104200/50	100 mm E 6.3	11,1 x 35 mm	with
14300154100/50	150 mm E 6.3	10,0 x 35 mm	w/o
14300154200/50	150 mm E 6.3	11,1 x 35 mm	with

Many other versions available upon request. Please contact our sales staff for further information!

Chisels & Punches

Flat Chisels DIN 6453

chrome-vanadium steel, oval shank

Art. No.	size (mm)	slitting width (mm)
312-100	100 x 14 x 9	15
312-125	125 x 14 x 9	15
312-150	150 x 17 x 11	18
312-175	175 x 20 x 12	21
312-200	200 x 23 x 13	24
312-250	250 x 23 x 13	25
312-300	300 x 23 x 13	26
312-400	400 x 26 x 13	32



Stone Chisels DIN 7254 B

chrome-vanadium steel, oval shank

Art. No.	size (mm)	slitting width (mm)
310-20-200	200 x 20 x 12	25
310-20-250	250 x 20 x 12	25
310-23-300	300 x 23 x 13	28
310-23-350	350 x 23 x 13	28
310-23-400	400 x 23 x 13	28
310-26-500	500 x 26 x 13	31
310-26-600	600 x 26 x 13	31
310-26-800	800 x 26 x 13	33



Mason's Chisels DIN 7254 A

chrome-vanadium steel, octagonal shank

Art. No.	size (mm)	slitting width (mm)
311-100	100 x 10 x 12	12
311-125	125 x 10 x 12	12
311-150	150 x 12 x 16	16
311-200	200 x 16 x 19	19
311-250	250 x 16 x 23	23
311-300	300 x 18 x 26	26
311-350	350 x 18 x 26	26
311-400	400 x 18 x 26	26
311-500	500 x 20 x 30	30



Pointed Chisels DIN 7256

chrome-vanadium steel, octagonal shank

Art. No.	size (mm)
308-200	200 x 16
308-250	250 x 16
308-300	300 x 18
308-350	350 x 18
308-400	400 x 18
308-500	500 x 20



Arch Punches & Sets

Arch/Wad Punches

according to DIN 7200 A, drop forged, blue lacquered oven finish, channel polished



Art. No.	size (mm)	Art. No.	size (mm)	Art. No.	size (mm)	Art. No.	size (mm)	Art. No.	size (mm)	Art. No.	size (mm)
0100010	1	0100060	6	0100150	15	0100250	25	0100350	35	0100450	45
0100015	1,5	0100065	6,5	0100160	16	0100260	26	0100360	36	0100460	46
0100020	2	0100070	7	0100170	17	0100270	27	0100370	37	0100470	47
0100025	2,5	0100080	8	0100180	18	0100280	28	0100380	38	0100480	48
0100030	3	0100090	9	0100190	19	0100290	29	0100390	39	0100490	49
0100035	3,5	0100100	10	0100200	20	0100300	30	0100400	40	0100500	50
0100040	4	0100110	11	0100210	21	0100310	31	0100410	41		
0100045	4,5	0100120	12	0100220	22	0100320	32	0100420	42		
0100050	5	0100130	13	0100230	23	0100330	33	0100430	43		
0100055	5,5	0100140	14	0100240	24	0100340	34	0100440	44		

other sizes are available upon request

Arch Punch Sets

plain, blue lacquered oven finish, with polished channel, according to DIN 7200 A, in roll-up pouch

Available Sets:

Art. No.	pcs per set	sizes (mm)
0122930	6	2-4-6-8-10-12
0120810	8	3-6-8-10-12-16-20-25
0120310	8	3-5-7-8-10-13-16-19
0120410	9	3-5-7-8-10-13-16-19-22
0120510	10	3-5-7-8-10-13-16-19-22-25
0120660	12	3-5-6-8-10-12-13-14-16-20-22-25

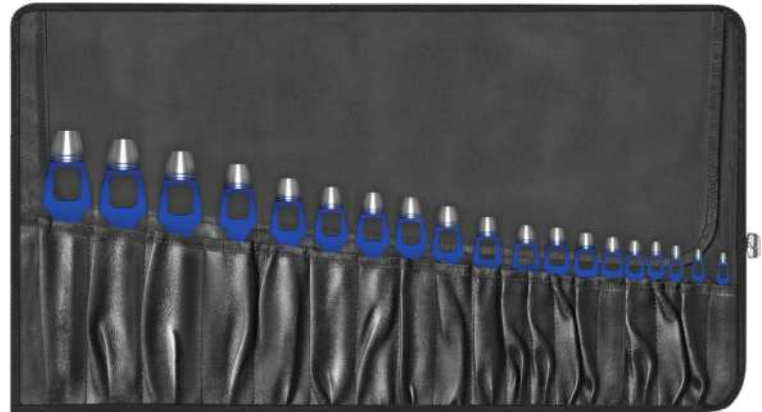

other sets with different sizes are available upon request

Belt Punches

according to DIN 7200 B, plain, blue lacquered oven finish, with fine polished nose



Art. No.	mm	inch	Art. No.	mm	inch	Art. No.	mm	inch	Art. No.	mm	inch
0200010	1	1/32	0200050	5	3/16	0200110	11	7/16	0200190	19	3/4
0200015	1,5		0200055	5,5		0200120	12	15/32	0200200	20	25/32
0200020	2	1/16	0200060	6	7/32	0200130	13	1/2	0200210	21	13/16
0200025	2,5		0200065	6,5		0200140	14	9/16	0200220	22	7/8
0200030	3	1/8	0200070	7	1/4	0200150	15	19/32	0200230	23	29/32
0200035	3,5		0200080	8	5/16	0200160	16	5/8	0200240	24	15/16
0200040	4	5/32	0200090	9	11/32	0200170	17	21/32	0200250	25	1
0200045	4,5		0200100	10	3/8	0200180	18	11/16			

Chisels & Punches



Belt Punch Sets

plain, blue, lacquered oven finish, with fine polished nose, according to DIN 7200B,

in roll-up pouch



Art. No.	pcs per set	sizes (mm)
0220022/B	7	3-5-7-8-10-11-13
0220032/B	8	3-5-7-8-10-13-16-19
0220012/B	9	2-3-4-5-6-7-8-9-10
0220042/B	9	3-5-7-8-10-13-16-19-22
0220052/B	10	3-5-7-8-10-13-16-19-22-25

Center Punches

Chrome-vanadium steel, octagon shank, polished point, lacquered oven finish, available with blue (B) or golden brown lacquered shank.

Art. No. (blue)	Art. No. (golden brown)	sizes (mm)
105-100x8/B	105-8	100 x 8
105-10/B	105-10	100 x 10
105-12/B	105-120	120 x 10
105-150x16/B	105-12	120 x 12
105-180x16/B	105-150	150 x 12



Brad Punches

chrome-vanadium steel, octagon shank, lacquered oven finish

Art. No.	Art. No.	point (mm)	Art. No.	Art. No.	point (mm)
100-1	120 x 10	1	100-7	120 x 12	7
100-2	120 x 10	2	100-8	120 x 12	8
100-3	120 x 10	3	100-9	150 x 12	9
100-4	120 x 10	4	100-10	150 x 12	10
100-5	120 x 10	5	100-12	150 x 14	12
100-6	120 x 12	6	100-16	175 x 18	16

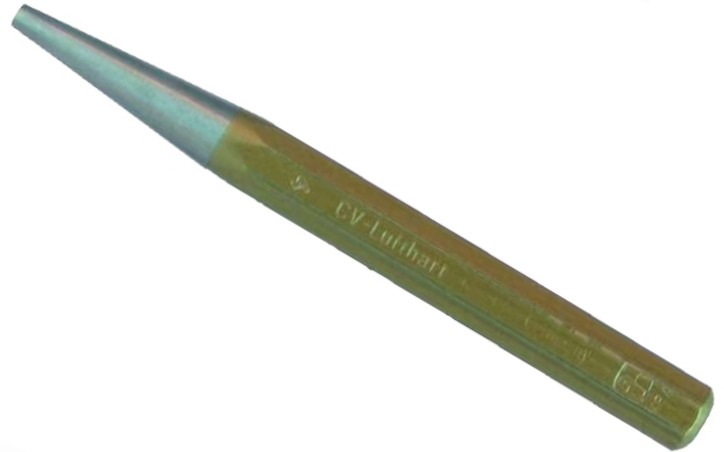

Parallel Pin Punches

chrome-vanadium steel, octagon shank, lacquered oven finish

Art. No.	size (mm)	point (mm)	Art. No.	size (mm)	point (mm)
110-2	150 x 10	2	110-9	150 x 12	9
110-2,5	150 x 10	2,5	110-10	150 x 12	10
110-3	150 x 10	3	110-12	150 x 14	12
110-4	150 x 10	4	110-14	175 x 16	14
110-5	150 x 10	5	110-16	200 x 18	16
110-6	150 x 10	6	110-18	200 x 20	18
110-7	150 x 12	7	110-20	250 x 22	20
110-8	150 x 12	8			

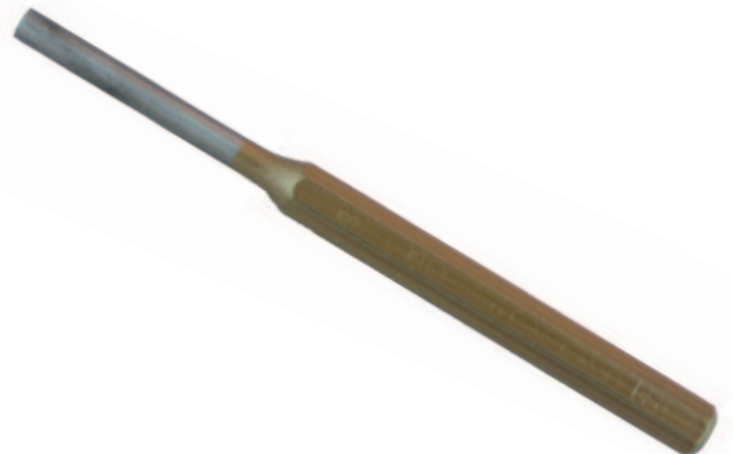

other sizes/set combinations are available on request

Chisels & Punches

Tool Sets

6 pieces set, made of chrome-vanadium self-hardening steel

- consisting of:
- flat chisels:
 - 125 x 10 x 12 mm
 - 150 x 12 x 16 mm
 - centre punch:
 - 150 x 12 mm
 - brad punches:
 - 120 x 10 x 2 mm
 - 120 x 10 x 3 mm
 - 120 x 10 x 4 mm



Art. No. 225 in PVC wallet

Pin Punch Sets

6 pieces set, octagonal, made of chrome-vanadium self-hardening steel, with non spread head, acc. to DIN 6450 C, lacquered oven finish

- consisting of:
- pin punches:
 - 3 mm
 - 4 mm
 - 5 mm
 - 6 mm
 - 7 mm
 - 8 mm



Art. No. 290 in PVC wallet

Tool Sets

6 pieces set, made of chrome-vanadium self-hardening steel

- consisting of:
- flat chisels:
 - 125 x 10 x 12 mm
 - 150 x 12 x 16 mm
 - centre punch:
 - 150 x 12 mm
 - brad punches:
 - 120 x 10 x 2 mm
 - 120 x 10 x 3 mm
 - 120 x 10 x 4 mm



Art. No. 210 in PVC case

Pin Punch Sets

6 pieces set, octagonal, made of chrome-vanadium self-hardening steel, with non spread head, acc. to DIN 6450 C, lacquered oven finish

- consisting of:
- pin punches:
 - 3 mm
 - 4 mm
 - 5 mm
 - 6 mm
 - 7 mm
 - 8 mm



Art. No. 265 in PVC case

Brad and Centre Punch Sets

6 pieces set, made of chrome-vanadium steel, plain, polished point, lacquered oven finish

- consisting of:
- brad punches:
 - 120 x 10 x 2, 3, 4, 5, 6 mm
 - centre punch:
 - 120 x 12 mm



Art. No. 235 in PVC case

Pin Punch Sets

6 pieces set, octagonal, chrome-vanadium steel, acc. to DIN 6450 C, consisting of 3, 4, 5, 6, 7, 8 mm



Art. No. 270 in metal box



Art. No. 280 in PVC box

Number & Letter Punches

Sets of Figure Punches A-Z

27 pcs sets in blue plastic box, pointed (with sight edge), according to DIN 1451



Art. No.	size (mm)	Art. No.	size (mm)
10101000	1	10108000	8
10102000	2	10109000	9
10103000	3	10110000	10
10104000	4	10111000	11
10105000	5	10112000	12
10106000	6	10114000	14
10107000	7	10115000	15

Sets of Number Punches 0-9

9 pcs sets in blue plastic box, pointed (with sight edge), according to DIN 1451



Art. No.	size (mm)	Art. No.	size (mm)
10001000	1	10008000	8
10002000	2	10009000	9
10003000	3	10010000	10
10004000	4	10011000	11
10005000	5	10012000	12
10006000	6	10014000	14
10007000	7	10015000	15



Art. No.	size (mm)	execution	Art. No.	size (mm)	execution	Art. No.	size (mm)	execution	Art. No.	size (mm)	execution
2010	10	A-Z - 27 pcs	2080	80	A-Z - 27 pcs	3010	10	0-9 - 9 pcs	3080	80	0-9 - 9 pcs
2015	15	A-Z - 27 pcs	2090	90	A-Z - 27 pcs	3015	15	0-9 - 9 pcs	3090	90	0-9 - 9 pcs
2020	20	A-Z - 27 pcs	2100	100	A-Z - 27 pcs	3020	20	0-9 - 9 pcs	3100	100	0-9 - 9 pcs
2025	25	A-Z - 27 pcs	2120	120	A-Z - 27 pcs	3025	25	0-9 - 9 pcs	3120	120	0-9 - 9 pcs
2030	30	A-Z - 27 pcs	2150	150	A-Z - 27 pcs	3030	30	0-9 - 9 pcs	3150	150	0-9 - 9 pcs
2035	35	A-Z - 27 pcs	2180	180	A-Z - 27 pcs	3035	35	0-9 - 9 pcs	3180	180	0-9 - 9 pcs
2040	40	A-Z - 27 pcs	2200	200	A-Z - 27 pcs	3040	40	0-9 - 9 pcs	3200	200	0-9 - 9 pcs
2050	50	A-Z - 27 pcs	2250	250	A-Z - 27 pcs	3050	50	0-9 - 9 pcs	3250	250	0-9 - 9 pcs
2060	60	A-Z - 27 pcs	2300	300	A-Z - 27 pcs	3060	60	0-9 - 9 pcs	3300	300	0-9 - 9 pcs
2070	70	A-Z - 27 pcs				3070	70	0-9 - 9 pcs			

Sets of Figure and Number Stencils A-Z

- made of zinc plate
- according to DIN 1451



Signograph 25 Sets

a powerful engraver with interchangeable hardened stylus and hart metal stylus

- especially suitable for hard metals and for all soft metals, plastic etc.



Art. No.	1500743	with 1,8 mtr. cable and BS plug (13A)
Art. No.	1500740	with 1,8 mtr. and cable and Schuko plug (16A)

Sealing Compound

CORTECO brand Universal Sealing Compound EVO300

colour: anthracite grey
 paste type: 100% silicone,
 temperature resistance up to +300° C,
 in display cartons of 25 pieces

For automotive and industrial applications. Wherever resistance required to oil leaks and temperatures in engines with steel or cast iron case (sumps, cylinder heads, oil pumps, differentials etc.)

Easily adapts to uneven or irregular surfaces. Good resistance to coolants and chemical agents.



Art. No.	content	carton unit	pallet unit
49372187	70 ml	25 pcs	2.250 pcs

CROLDINO HAND-CLEANING PASTE

cleans thoroughly and protects skin from oil, grease and lubricants. Bio-degradable and clinically tested. Contains special hand care components. Ideal for workshop, home use and industrial.

Art. No.	content
01 000310	500 ml



DURSOL® SHINE

cleaning and care products for all objects made of aluminium, chrome, steel, brass, copper, tin, etc. In one operation the surface is cleaned, preserved and a tarnishing is delayed. Achieves brilliant high gloss.

Art. No.	content
01 001188	75 ml



AUTOSOL® METAL POLISH

world-famous and internationally awarded cleaning and care product for all metallic surfaces. Contamination and rust can be easily removed in a single operation. Due to the balanced formulation of the active ingredients, surface protection is applied to the metals in addition to excellent cleaning. Achieves brilliant high gloss.

Art. No.	content
01 001000	75 ml



AUTOSOL® STAINLESS STEEL POLISH

specially developed for cleaning and polishing stainless steel. Leaves a radiant high gloss without scratching the surface.

Art. No.	content
01 001734	75 ml



AUTOSOL® GOLD & SILVER POLISH

ideal care product for surfaces made of gold, silver and other precious metals. The surfaces are cleaned and conserved in one operation. Effectively delays the tarnishing of silver. Achieves a radiant high gloss.

Art. No.	content
01 001050	75 ml



Funnels

PRESSOL

Funnel Sets

polyethylene, oil, acid and fuel-resistant, colour: orange



Art. No.	pcs per set	Ø (mm)
02 360	4	50, 75, 100, 120
02 360 954	5	50, 75, 100, 120, 150
02 372 043 with brass strainer	6	50, 75, 100, 120, 150, 160

Funnels

steel plated, oil and diesel resistant, handmade, available with straight spout or flexible metal spout (with removable brass strainer)



Art. No.	Ø (mm)	height (mm)	version
02 342	160	220	straight
02 344	200	280	straight
02 645	160	220	flex. spout 300 mm
02 344 950	200	280	flex. spout 300 mm

Funnels

polyethylene, straight spout, with ventilation tube, oil, acid and fuel-resistant, foodstuff compatible colour: orange



Art. No.	Ø (mm)	brass strainer	height (mm)
02 361	50		80
02 362	75		110
02 363	100		130
02 364	120		160
02 365	150		180
02 366	200		220
02 366 017	200	X	220
02 367	250		255
02 367 020	250	X	255

Funnels

polyethylene, with black flexible removable discharge spout (330 mm), oil, acid and fuel-resistant colour: orange



Art. No.	Ø (mm)	height (mm)
02 665	150	490

Funnels

polyethylene, with flexible removable discharge spout (330 mm), oil, acid and fuel-resistant, with safe handle colour: orange



Art. No.	Ø (mm)	height (mm)	version
02 662	160	470	
02 674	160	470	with brass strainer

Combi Funnels

polyethylene, with angled safety spout 200 mm and removable brass strainer colour: orange



Art. No.	Ø (mm)	height (mm)
02 562	160	260

Funnels

polyethylene, with flexible removable metal discharge spout (300 mm), with tread connection and removable brass strainer colour: orange



Art. No.	Ø (mm)	height (mm)
02 675	160	330

Funnels & Oilers

PRESSOL

Funnels

polyethylene, straight spout,
oil, petrol and acid resistant,
with removable brass strainer
colour: orange



Art. No.	Ø (mm)	height (mm)
02 372	160	205

Flexible Discharge Spouts

metal
suitable for funnels:
02 342, 02 344, 02344 950,
02 645



Art. No.	length (mm)
02 640	300

Flexible Discharge Spouts

polyethylene
suitable for funnels:
02 372, 02 662, 02 674,
colour: orange



Art. No.	length (mm)
00 238	320

Oil Bottle Funnels

polyethylene,
oil, acid and fuel-resistant
colour: orange



Art. No.	Ø (mm)	height (mm)
02 671	120	160

Oilers

polyethylene container with sealing clip
colour: white-transparent

Art. No.	cap (ml)	height (mm)
06 068	60	120
06 064	125	175
06 065	250	200
06 066	500	245



Funnels

polyethylene, straight spout
oil, acid and fuel-resistant
foodstuff-compatible
colour: white transparent



Art. No.	Ø (mm)	height (mm)
02 369	350	435

Oilers

polyethylene container
and brass spout
colour: white-transparent

Art. No.	cap (ml)	height (mm)
06 863	50	130
06 864	125	160
06 865	250	185
06 866	500	230



06 863 06 864
06 865
06 866

Industrial Oilers Metal Container

single-acting brass pump
with rigid aluminium (135 mm) and
superflex spout (210 mm)
colour: blue



Art. No.	cap (ml)	height (mm)
05 223	250	110
05 224	350	120
05 225	500	150
05 226	750	200

Oilers



Standard Oilers - Metal Container

single-acting plastic pump,
with rigid aluminium or superflex spout
colour: red

Art. No.	cap (ml)	height (mm)	spout	spout length (mm)
05 113	250	110	rigid	135
05 133	250	110	superflex	210
05 114	350	120	rigid	135
05 134	350	120	superflex	210
05 115	500	150	rigid	135
05 135	500	150	superflex	210



Standard Oilers

single-acting plastic pump,
with rigid spout or with superflex spout
colour: white-transparent

Art. No.	cap (ml)	height (mm)	spout	spout length (mm)
05 118	350	135	rigid	135
05 138	350	135	superflex	210
05 119	500	150	rigid	135
05 139	500	150	superflex	210



DIY Oilers - Polyethylene Container

single-acting plastic pump and aluminium spout
colour: white-transparent

Art. No.	cap (ml)	height (mm)	spout length (mm)
04 111	150	215	105



Industrial Oilers

single-acting brass pump with gravity controlled
suction tube and aluminium spout

Art. No.	cap (ml)	height (mm)	colour	spout length (mm)
03 802	200	270	metallic grey	135
04 802	200	270	white	135
03 803	300	320	metallic grey	165
04 803	300	320	white	165
03 805	500	350	metallic grey	165
04 805	500	350	white	165



03 80...
zinc die cast container



04 80...
polyethylene container

Measures & Cans

PRESSOL

Measuring Jugs

polypropylene
with scale
oil and acid resistant
foodstuff-compatible
stackable
colour: transparent



Art. No.	cap (liter)	height (mm)
07 060	0.25	120
07 061	0.5	135
07 062	1.0	170
07 063	2.0	215
07 064	3.0	240
07 065	5.0	270

Measuring Cylinders

polypropylene
with scale, break-proof
safe dispensing
colour: transparent



Art. No.	cap (liter)	height (mm)
07 160	0.025	170
07 161	0.05	200
07 162	0.10	255
07 163	0.25	310
07 164	0.5	345
07 165	1.0	415

Measuring Jugs

polyethylene
with scale
oil, acid and fuel-resistant
foodstuff-compatible
colour: white-transparent



Art. No.	cap (liter)	height (mm)
07 500	0.5	190
07 501	1.0	230
07 502	2.0	290
07 503	3.0	335
07 505	5.0	380

Flexible Discharge Spout

polypropylene
length: 160 mm **with sealing ring**
colour: white-transparent
suitable for:
07 500, 07 501, 07 502



Art. No.
00 328 950

Measuring Jugs

handmade, tin plated
with polyethylene safety spout
ergonomic handle



Art. No.	cap (liter)	height (mm)
07 341	0.5	230
07 342	1.0	270
07 343	2.0	320

Measuring Jugs

handmade, tin plated
with flexible metal spout
ergonomic handle



Art. No.	cap (liter)	height (mm)
07 642	1.0	370
07 643	2.0	410

Grease Guns



One Hand Grease Guns

with straight spout (150 mm)
wall thickness of tube: 1.0 mm
L-design handle
lacquering: silver
capacity 500 ccm
in single carton box packing

Can be switched with the handgrip from grease delivery
with high volume to high pressure



Art. No.
Piston Ø
Connection
Thickness of tube
loading grease

12 250
8 mm
M 10 x 1
1.0 mm
400 g cartridge

12 270
8 mm
G 1/8"
1.0 mm
400 g cartridge

Compressed Air Grease Guns

with 4 jaws hydraulic coupler
wall thickness of tube: 1.0 mm
L-design handle
pressure ratio: 50:1
lacquering: silver
capacity 500 ccm
in single carton box packing



Art. No.
Piston Ø
Connection
Thickness of tube
loading grease
Coupler
Specification

18 071
6 mm
M 10 x 1
1.0 mm
400 g cartridge
hydraulic
angled spout
(150 mm)

18 072
6 mm
M 10 x 1
1.0 mm
400 g cartridge
precision machined
high pressure hose
(11 x 300 mm)

Grease Guns



Grease Gun, Standard

manually lever operated
with hydraulic coupler, with 4 jaws
- Ø piston 8 mm
- connection M 10 x 1
- wall thickness of tube 1 mm
- loading grease cartridge 400 g
- L-design handle
- lacquering: silver
- capacity 500 ccm



Art. No.	12 632 (12 632 980)	12 634	12 630 (12 630 980)	12 633 (12 633 980)
Piston Ø	8 mm	8 mm	8 mm	8 mm
Specification	angled spout (150 mm)	angled spout (150 mm)	high pressure hose (8 x 300 mm)	high pressure hose (8 x 300 mm)
Packing	Packed in polybag	Packed in carton packing	Packed in polybag	Packed in carton packing

Grease Gun

manually lever operated
with hydraulic coupler, with 4 jaws
- connection M 10 x 1
- wall thickness of tube 1 mm
- loading grease cartridge 400 g
- L-design handle
- lacquering: black
- capacity 500 ccm



Art. No.	12 632 (12 632 981)	12 675
Piston Ø	8 mm	9 mm
Wall thickness	1 mm	1.5 mm
Handle	L-design	T-design
Specification	angled spout (150 mm)	angled spout (150 mm)
Packing	Packed in Polybag	Packed in carton packing

Grease Nipple Assortments

various sizes,
packed in transparent sales box

Art. No.	pcs per set
16 092	70
16 090	140
16 099	387



16 092



16 090



16 099

Grease Gun Accessories



Button Head Couplers

flat design, M 10 x 1 - female, for button head grease nipples, slide on type, M- and T-nipples



Art. No.	connection
12 061	16 mm

Button Head Couplers

flat design, M 10 x 1 - female, for button head grease nipples, M- and T-nipples



12 060



12 062

Art. No.	connection
12 060	10 mm
12 062	16 mm

Button Head Couplers

flat design, M 10 x 1 - female, for button head grease nipples, M- and T-nipples



Art. No.	connection
12 063	22 mm

Angled Connectors

for button head grease nipples, steel galvanized - 90° angle



Art. No.	connection
12 035	M 10 x 1 - male
12 035 805	G 1/8" - male

Bayonet Couplers

for all bayonet type grease nipples, galvanized, 14 mm size: 20 x 41 mm



Art. No.	connection
12 013	M 10 x 1 - female
12 023	G 1/8" - female

Quick Release Adaptors

for hydraulic coupler, steel galvanized, 12 mm size: 18 x 31 mm



Art. No.	connection
12 006	M 10 x 1 - female
12 006 125	G 1/8" - female

Hydraulic Couplers

with 4 jaws, Ø15 mm for H-nipples, made of galvanized steel



Art. No.	connection
12 631 980	M 10 x 1 - female
12 731 980	G 1/8" - female

Precision Machined Couplers

with 4 jaws, turned, Ø 15 mm for H-nipples, made of galvanized steel



Art. No.	connection
12 643 980	M 10 x 1 - male
12 743 980	G 1/8" - male



Push Type Guns



Oil Suction Guns

steel body - single action,
with flexible transparent hose 350 mm,
with PVC cover, colour: blue



Art. No.	ml
12 902	500

Oil Suction Guns

polished brass body, single action,
with angled brass spout 135 mm,
with zinc end caps, colour: gold



Art. No.	ml
12 935	500

Oil Suction Guns

galvanized steel body, single action,
with flexible transparent hose 350 mm,
with zinc end caps



Art. No.	ml
12 907	500
12 908	1000

High Pressure Grease Hoses DIN 1283

reinforcement: polyester, high-strength
burst pressure: 900 bar

Art. No. M 10 x 1 male	Art. No. G 1/8" male	size (mm)
12 656	12 756	8 x 300
12 666	12 766	8 x 500
12 655	12 755	11 x 300
12 665	12 765	11 x 500



High Pressure Grease Hoses DIN 1283 with hydraulic coupler

reinforcement: polyester, high-strength
burst pressure: 900 bar

Art. No. M 10 x 1 male	Art. No. G 1/8" male	size (mm)
12 656 810	12 756 810	8 x 300
12 666 810	12 766 810	8 x 500
12 655 809	12 755 809	11 x 300
12 665 809	12 765 809	11 x 500



Push Type Guns for Grease

galvanized steel casing,
for hydraulic and ball type grease nipples
pressure 60 to 80 bar

Art. No.	ml
12 362	80
12 363	150
12 365	300



Push Type Guns for Grease

plastic casing, pressure 20 bar
with pointed coupler, funnel type or
with universal coupler, ball type

Art. No. pointed coupler	Art. No. universal coupler	ml
12 321	12 331	65
12 322	12 332	150

pointed coupler



universal coupler



Grease Nipples



Type H1 - DIN 71 412

straight, 180°, hexagon version
galvanized or stainless steel

Art. No. galvanized	size	SW (mm)	A (mm)	B (mm)
15 000	1/4" BSF	7	15	5.5
15 007	M 6 x 1	7	15	5.5
15 009	M 8 x 1	9	15	5.5
15 010	M 8 x 1,25	9	15	5.5
15 013	M 10 x 1	11	15	5.5
15 014	M 10 x 1,25	11	15	5.5
15 015	M 10 x 1,5	11	15	5.5
15 026	1/8" NPT	11	15	5.5
15 037	G 1/8"	11	15	5.5
15 071	F 6 x 1 SFG	7	15	5.5
15 027	G 1/4" NPT	14	19	8
15 038	G 1/4"	14	16	6.5



Art. No. stainless st.	size	SW (mm)	A (mm)	B (mm)
15 907	M 6 x 1	7	15	5.5
15 909	M 8 x 1	9	15	5.5
15 913	M 10 x 1	11	15	5.5
15 926	1/8" NPT	11	15	5.5
15 937	G 1/8"	11	15	5.5
15 938	R 1/4"	14	17.5	6.5

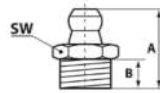

Type H2 SK - DIN 71 412

hexagon version - 45°
angled, galvanized

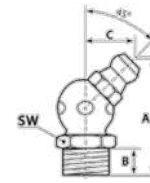

Art. No.	size	SW (mm)	A (mm)	B (mm)	C (mm)
15 100 140	1/4" BSF	9	23.5	5.5	10.5
15 107 140	M 6 x 1	9	23.5	5.5	10.5
15 108	M 7 x 1	10	23.5	5.5	10.5
15 109 140	M 8 x 1	9	23.5	5.5	10.5
15 110 140	M 8 x 1,25	9	23.5	5.5	10.5
15 113 140	M 10 x 1	11	25	5.5	11.5
15 115 140	M 10 x 1,5	11	25	5.5	11.5

Type H2 VK - DIN 71 412

square version - 45°
angled, galvanized

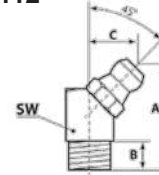

Art. No.	size	SW (mm)	A (mm)	B (mm)	C (mm)
15 172	F 8 x 1 SFG	9	20.5	5.5	10.5
15 173	F 10 x 1 SFG	11	20.5	5.5	11
15 100	1/4" BSF	9	23.5	5.5	10.5
15 107	M 6 x 1	9	23.5	5.5	10.5
15 109	M 8 x 1	9	20.2	5.5	10.5
15 110	M 8 x 1,25	9	20.2	5.5	10.5
15 113	M 10 x 1	11	20.5	5.5	11.5
15 115	M 10 x 1,5	11	20.5	5.5	11.5
15 137	G 1/8"	11	20.5	5.5	11.5

M1 Button Head Grease Nipples - DIN 3404

hexagon version, galvanized

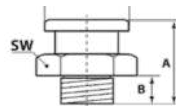

Art. No.	size	SW (mm)	A (mm)	B (mm)	C (mm)
57 807	M 6 x 1	17	17	6	16
57 809	M 8 x 1	17	17	6	16
57 810	M 8 x 1,25	17	17	6	16
57 813	M 10 x 1	17	17	6	16
57 815	M 10 x 1,5	17	17	6	16
57 817	M 12 x 1,5	17	17	6	16
57 837	G 1/8"	17	17	6	16
57 838	G 1/4"	17	17	6	16

round head



Art. No.	size	SW (mm)	A (mm)	B (mm)	C (mm)
55 807	M 6 x 1	15	16	6	16.5
55 809	M 8 x 1	15	16	6	16.5
55 810	M 8 x 1,25	15	16	6	16.5
55 813	M 10 x 1	15	16	6	16.5
55 815	M 10 x 1,5	15	16	6	16.5
55 837	G 1/8"	15	16	6	16.5
55 838	G 1/4"	15	16	6	16.5

hex. head



Type H3 VK - DIN 71 412

square version - 90°
angled, galvanized

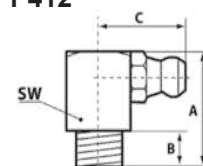

Art. No.	size	SW (mm)	A (mm)	B (mm)	C (mm)
15 200	1/4" BSF	9	18	5.5	14
15 207	M 6 x 1	9	18	5.5	14
15 209	M 8 x 1	9	18	5.5	14
15 210	M 8 x 1,25	9	18	5.5	14
15 213	M 10 x 1	11	18	5.5	15
15 215	M 10 x 1,5	11	18	5.5	15
15 237	G 1/8"	11	18	5.5	15



Manual Pumps



& Jerry Cans

Steel Barrel Pumps, Manual Operation

suitable for 60l, 200 l and 220 l containers,
galvanized steel components

Art. No. 13 012

- without accessories
- delivery rate/stroke: 16 l/min.
- adjustable in length (from 355 to 955 mm)
- completely dismountable

Art. No. 13 012 954

- with accessories / gear oil installation kit (1,5 m hose)
- with anti-drip nozzle
- delivery rate/stroke: 16 l/min.
- adjustable in length (from 355 to 955 mm)

Art. No. 13 016

- without accessories
- delivery rate/stroke: 10 l/min.
- steel discharge spout



13 012



13 012 954



13 016

Rotary Pumps

suitable for 60l, 200l containers
suction tube length: 980 mm,
with suction tube and discharge spout,
delivery rate/stroke 18 l/min.
Smooth hand-rotating operation,
telescopic suction tube, adjustable in length (from 355 to 955 mm)
the pump is continuously positionable in 360°
assembly without tools

Art. No. 13 055

- without accessories

Art. No. 13 056

- with accessories
- complete with discharge hose 2 m length, hose clips, anti-kink spring



13 055



13 056

Jerrycans - Steel

suitable for liquid fuels
mad of pickled sheet steel 0.8 mm
small neck dia. 30 mm, colour olive-green
other colours available upon request
packing: 70 pcs/pallet
manufactured and tested to comply with
German DIN/TÜV/GS and American AS 2906 standard

- without inside coating
- optionally available with inside coating



Art. No.	capacity (liter)	height (mm)
CAN 5 L	5	275
CAN 10 L	10	390
CAN 20 L	20	470

Fuel Cans

high density polyethylene
with flexible spout - cover cap
suitable for liquid fuels
UN-approval
colour: red



Art. No.	capacity (liter)	height (mm)
21 131	5	237
21 133	10	319
21 137	20	410

Manual Pumps &



Waste Oil Disposals

Manually Operated Grease Lubrication Systems

manually lever operated
 discharge pressure: up to 550 bar
 burst pressure: 850 bar
 suitable for 20 kg container, Ø 270-310 mm
 dust cover (17 076)
 stabilising-fixing brackte (17 300)
 one hand operated grease gun
 connection M 10 x 1 (17 600)
 spout, straight, M10 x 1, 150 mm (12 435)
 coupler, 4 jaws, M 10 x 1 (12 631)
 discharge hose, 1,5 m (17 003)
 suction tube length 510 mm

Art. No. 17 620



Oil Dispenser Units

14 kg container
 container size 220 x 380 mm
 manually operated
 delivery rate/stroke 85 cm³
 complete set with all accessories
 and foot rest
 colour: grey satin RAL 7040

Art. No. 17 790

mobile,
 with 2 fixed wheels

Art. No. 17 785

portable,
 with foot rest



Grease Dispenser Unit

16 kg container
 container size 220 x 380 mm
 manually operated
 deliveryrate/stroke: 10 cm³
 discharge pressure 25 bar
 complete set with all accessories and foot rest
 standard colour: grey satin RAL 7040

Art. No. 17 791

portable
 with foot rest

Art. No. 17 792

mobile
 with 2 fixed wheels



Waste Oil Drainers

mobile, air pressured oil evacuation,
 Ø drain bowl 420 mm - volume: 18 l
 telescopic height level: 1180 - 1750 mm,
 male quick release adapter G 1/4", NW 7.2
 for rectus coupling
 transparent discharge hose - 2 m
 2 fixed rear wheels, 2 front castor wheels
 standard body lacquering: grey satin RAL 7040
 bowl: blue RAL 5010

Art. No. 27 070

75 l



Waste Oil Disposals & Oil, **PRESSOL** Grease & Water supplies

Waste Oil Suction Units VENTURI System

mobile, 2 airline connections
 recommended air pressures: 6 bar
 male quick release adapter G 1/4, NW 7.2
 for rectus coupling
 with suction hose 2 m with spiral spring
 lever ball valve with suction probe adapters
 for: VW/Audi, Mercedes, BMW, Smart

2 fixed rear wheels, 2 front castor wheels,
 standard body lacquering: grey satin RAL 7040

Art. No. 27 622 75 l

Art. No. 27 632 75 l

with visual inspection reservoir 7 l



Waste Oil Drainers-/Suction Units VENTURI System

mobile, 2 airline connections, Ødrain bowl 420 mm,
 telescopic height level: 1180 - 1750 mm
 male quick release adapter G 1/4, NW 7.2,
 for rectus coupling
 with transparent discharge hose
 lever ball valve with suction probe adapters
 for: VW/Audi, Mercedes, BMW, Smart

2 fixed rear wheels, 2 front castor wheels,
 standard body lacquering: grey satin RAL 7040

Art. No. 27 622 680 75 l

Art. No. 27 632 680 75 l

with visual inspection reservoir 7 l



Hose Reels for Oil - Grease and Water/Air supply

Wall/Floor mounting versions
 open or encase hose reels

Art. No. open	Art. No. encased	hose reel	bar	DN	connection threads	hose length
29 142	29 172	oil	120	12	G 1/2" male and female	10 m
29 143	29 173	oil	120	12	G 1/2" male and female	15 m
29 242	29 272	grease	400	6	G 1/4" male and female	10 m
29 243	29 273	grease	400	6	G 1/4" male and female	15 m
29 442	29 472	water/air	20	10	G 3/8" male and female	10 m
29 443	29 473	water/air	20	10	G 3/8" male and female	15 m
29542	29 572	cooling agent	120	12	G 1/2" male and female	10 m
29543	29 573	cooling agent	120	12	G 1/2" male and female	15 m



Grease/Fresh Oil Supplies **PRESSOL**

Pneumatic Grease Supply Systems 50:1

high performance, dust cover, follower plate and adjustable stabilising fixing-bracket, high-pressure grease control gun, 360 degree Z-swivel connector, high-pressure grease hose 2 m, pressure reduction valve (8 bar pre-set), male quick release airline connector.

mobile - to suit 20 kg container

with trolley
Ø 270 - 310 mm, with 2 m grease hose

Art. No. 18 417 051



mobile - to suit 50 kg container

with trolley
Ø 335 - 385 mm, with 4 m grease hose

Art. No. 18 766 391

stationary - to suit 20 kg container

Ø 270 - 310 mm, with 2 m grease hose

Art. No. 18 419 051

stationary - to suit 200 kg container

Ø 540 - 590 mm

Art. No. 18 785 051 with 4 m grease hose

Art. No. 18 785 056 with 6 m grease hose



mobile - to suit 200 kg container

with trolley
Ø 540 - 590 mm

Art. No. 18 786 051 with 4 m grease hose

Art. No. 18 786 056 with 6 m grease hose



Pneumatic Grease Supply Systems 50:1

high performance - suction tube
dust cover, follower plate and adjustable stabilising-fixing bracket
pressure reduction valve (8 bar pre-set)
airline connection: G 1/4"

to suit 20 kg container

Ø 270 - 310 mm, suction pipe 600 mm

Art. No. 18 740 051

to suit 25 - 60 kg container

Ø 335 - 385 mm, suction pipe 700 mm

Art. No. 18 760 051

to suit 200 kg container

Ø 540 - 590 mm, suction pipe 1000 mm

Art. No. 18 780 051



Grease/Fresh Oil Supplies

PRESSOL

Pneumatic Grease Supply Systems 50:1

recommended air pressure: 8 bar (min. 2 bar / max. 10 bar)
 cylinder capacity engine 220 cm³, cylinder capacity pump 8 cm³
 quantity of strokes at 8 bar at a free-flow: 220 min
 pump capacity at 8 bar at a free flow: 1100 g/min.
 pump pressure at 8 bar air pressure: 400 bar
 air consumption at 8 bar air pressure: 400 l/min.
 airline connection: G 1/4"



suction tube length:

Art. No.	18 711 051	600 mm	to suit 20-30 kg container
Art. No.	18 713 051	700 mm	to suit 25-60 kg container
Art. No.	18 716 051	1000 mm	to suit 200 kg container

Pneumatic Oil and Diesel Pumps 1:1

fresh oil supply
 60 l / min.
 pressure side: G 3/4" male
 metal container connection: G 2" male
 airline connection: G 1/4" female
 suction tube length 860 mm G 1" male
 to suit 200 l/220 l metal container
 max. length of discharge hose 10 m



Art. No. 19 135

Pneumatic Oil and Diesel Pumps 3:1

fresh oil supply
 20 l / min.
 pressure side: G 1/2" male
 metal container connection: G 2" male
 airline connection: G 1/4" female
 suction tube length 860 mm G 3/4" male
 to suit 200 l/220 l metal container
 max. length of discharge hose 10 m



Art. No. 19 235

High Pressure Grease Control Guns

with hydraulic 4-claw coupler, straight spout
 operating pressure max 400 bar



Art. No. 18 104 G 1/8" female

Art. No. 18 114 G 1/4" female

Rotary Swivel Connectors

connection G 1/8" male, G 1/4" female
 finish: yellow galvanized steel



Art. No. 18 082 Z-swivel connector 3 x 360°

Art. No. 18 083 swivel connector 2 x 360°

Oil Control Valves

swivel connection G 1/2" female, galvanized steel spout
 operating pressure: 70 bar, automatic anti-drip nozzle
 manual switch-off

Art. No. 19 718



Fuel Oil / Diesel Supplies



PREMAxx Diesel Pump Sets

not selfpriming with 4 m discharge hose and 1,6 m suction hose
with on-off switch and motor-thermal-protection
hose connection: G 1" female, for 200 l containers and tanks
suction height: 2,5 m - discharge height: 15 m
drum connection: G 2" male



Art. No.	l/min.	v/hz	control gun	with...
23 731	52	230/50	standard	2 pin plug
23 737	52	230/50	automatic shut-off	2 pin plug
23 731 932	52	230/50	standard	13A BS plug
23 737 932	52	230/50	automatic shut-off	13A BS plug
23 721	43	24	standard	tapping clamps
23 727	43	24	automatic shut-off	tapping clamps
23 711	38	12	standard	tapping clamps
23 717	38	12	automatic shut-off	tapping clamps

MOBIFlx Diesel Pump Sets

selfpriming with 4 m discharge hose and 1,6 m suction hose
with on-off switch and 3 m electric connection cable
vane pump with integral bypass
max. suction height: 3 m
hose connection: G 1" female



Art. No.	l/min.	v	control gun	with...
23 015	35	12	standard nozzle	battery clips
23 006	35	12	automatic shut-off nozzle	battery clips
23 015 824	35	24	standard nozzle	battery clips
23 006 824	35	24	automatic shut-off nozzle	battery clips

Air Maintenance Units

complete with pressure regulator, manometer,
moisture separator and in-line lubricator, recommended
for use with pneumatic oil and grease pumps
connection: G 1/4" male, max. operating pressure 10 bar
with male quick release coupler
and wall mounting bracket



Art. No. 20 218 950

Regulators & Filters

Regulators

with wall screw clamp, pressure adjusting range 0 - 12 bar, blue colour, with pressure gauge thread



Art. No.	thread (inch)
AT-R18	1/8"
AT-R14	1/4"
AT-R12	3/8"-1/2"
AT-R34	3/4"
AT-R1	1"

Lubricators

suitable for filtered air, with wall screw clamp, blue colour

A) 12 bar with transparent clip

B) 18 bar, with metal cup



Art. No.	thread (inch)
AT-L18	1/8"
AT-L14	1/4"
AT-L12	3/8"-1/2"

Art. No.	thread (inch)
AT-LM18	1/8"
AT-LM14	1/4"
AT-LM12	3/8"-1/2"
AT-LM34	3/4"
AT-LM1	1"

Filter Regulators

with wall screw clamp, blue colour, with pressure gauge thread

A) pressure adjusting range 0 - 12 bar

B) pressure adjusting range 0 - 18 bar

with transparent cup

with metal cup



Art. No.	thread (inch)
AT-FR18	1/8"
AT-FR14	1/4"
AT-FR12	3/8"-1/2"

Art. No.	thread (inch)
AT-FRM18	1/8"
AT-FRM14	1/4"
AT-FRM12	3/8"-1/2"
AT-FRM34	3/4"
AT-FRM1	1"

Filters

with wall screw clamp, blue colour

A) pressure adjusting range 0 - 12 bar

B) pressure adjusting range 0 - 18 bar

with transparent cup

with metal cup

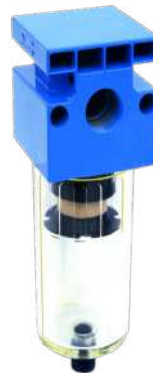

Art. No.	thread (inch)
AT-F18	1/8"
AT-F14	1/4"
AT-F12	3/8"-1/2"

Art. No.	thread (inch)
AT-FM18	1/8"
AT-FM14	1/4"
AT-FM12	3/8"-1/2"
AT-FM34	3/4"
AT-FM1	1"

Regulators & Filters



Filter Regulators + Lubricators

with wall screw clamp, blue colour

A) pressure adjusting
range 0 - 12 bar

B) pressure adjusting
range 0 - 18 bar

with transparent cup

with metal cup



Art. No.	thread (inch)
AT-FR+L18	1/8"
AT-FR+L14	1/4"
AT-FR+L12	3/8"-1/2"

Art. No.	thread (inch)
AT-FR+LM18	1/8"
AT-FR+LM14	1/4"
AT-FR+LM12	3/8"-1/2"
AT-FR+LM34	3/4"
AT-FR+LM1	1"

Filters + Regulators + Lubricators

with wall screw clamp, blue colour

A) pressure adjusting
range 0 - 12 bar

B) pressure adjusting
range 0 - 18 bar

with transparent cup

with metal cup



Art. No.	thread (inch)
AT-F+R+L18	1/8"
AT-F+R+L14	1/4"
AT-F+R+L12	3/8"-1/2"

Art. No.	thread (inch)
AT-LM18	1/8"
AT-LM14	1/4"
AT-LM12	3/8"-1/2"
AT-LM34	3/4"
AT-LM1	1"

Pressurs Filter Regulators

with lower connection (inf.) or rear connection (post.)
two adjustable air outlets with gauge Ø50 mm
aluminium body



Art. No. bayonet coupler	Art. No. universal coupler	connection (inch)
R10-INF.3/8"	R10UNI-INF.3/8"	lower conn. 3/8"
R14-INF.1/2"	R14UNI-INF.1/2"	lower conn. 1/4"
R10-POS.1/4"	R10UNI-POST.1/4"	rear conn. 1/4"
R14-POST.3/8"	R14UNI-POST.3/8"	rear conn. 3/8"

Car Washing Guns



nickel-plated aluminum body,
adjustable spare-jet regulator, max. 20 bar
Packing in single carton box
Connection thread 3/8" Female BSP
available with hose connector 3/8" Male BSP to 12 mm

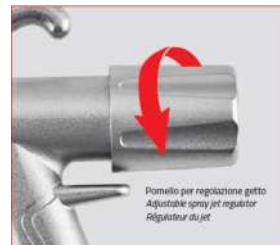

Art. No.	fitted nozzle	spare nozzle
JET2,5/3,5	2.5 mm	3.5 mm
JET2,5/2,5	2.5 mm	2.5 mm
JET3,5/2,5	3.5 mm	2.5 mm
JET3,5/3,5	3.5 mm	3.5 mm
JET2,5	2.5 mm	-
JET3,5	3.5 mm	-
JET0	-	-

Paint Spray & Washing Guns

Paint Spray Guns

packed in coloured single display box

with gravity cup
 tank capacity 500 ccm
 nylon cover, needle 1.5 mm
 operating pressure 4-8 bar

Art. No. 162A



with suction cup
 tank capacity 1000 ccm
 aluminium cover, needle 1.5 mm
 operating pressure 4-8 bar

Art. No. 162C



with suction cup
 tank capacity 1000 ccm
 PVC cover, needle 1.5 mm
 operating pressure 4-8 bar

Art. No. 701420



Paint Spray Guns

packed in coloured single display box
 with suction cup - tank capacity 1000 ccm
 with bayonet closing, aluminium cover
 needle 1.5 mm
 operating pressure 4-8 bar

Art. No. 162DS



Washing Guns

packing: 2 pcs/carton

GR 1000-tank and cover
 made from aluminium

Art. No. 61A



GR 1000-M30
 red steel tank

Art. No. 61B



connection possible with DIN 7,2
 connector or bayonet coupling 1/4"

Blow Guns & Tyre Inflating Guns



Blow Off Guns - Aluminium

in bulk packing
air flow 6 bar



Art. No. 60A

Blow Off Guns - Aluminium

in bulk packing
air flow 6 bar
with long tube



Art. No. 60B

Tyre Inflating Guns

manometer with pressure gauge Ø 63 mm
(marked with „Made in Italy“),
max. pressure 12 bar



Art. No. 60D 40 cm pipe

Digital Tyre Pressure Gauge

manometer Ø 63 mm
(marked with „Made in Italy“),
max. pressure 12 bar



Art. No. 60DD 50 cm pipe

Universal Head - Brass

clip-on connector

Art. No.	Ø (mm)	for hose in. Ø
60E/06	6	5 mm
60E/08	8	7 mm



Tyre Control Pressure Gauge

with pressure gauge Ø 63 mm
(marked with „Made in Italy“),
0-12 bar, with 40 cm tube with
chuck for direct attachment to
the valve



Art. No. 60F

Clip-on ball Foot Air Chucks

self-closing after detaching
from tyre valve (closed end)



Art. No.	Ø (mm)	hose Ø mm
14.4151	8	7
14.4171	9	8



Clip-on ball Foot Air Chucks

with female thread
self-closing after detaching
from tyre valve (closed end)



Art. No.	Ø (inch)
14.5451	1/4" - 18NPT
14.5851	1/8" - 27NPT



Service Station Tyre Inflating Chucks

Art. No.	Ø (mm)	hose Ø mm
14.6602	8	7
14.6805	9	8



Truck head with handgrip

Art. No.	Ø (mm)	hose in. Ø
60E2/06	6	5 mm
60E2/08	8	7 mm



Quick Couplings

Standard Quick-Disconnect Couplings DN 7,2

universal quick-disconnect couplings made of brass, blank, new stem profile for safe fit of the hose and assembly.

Couplings with male thread

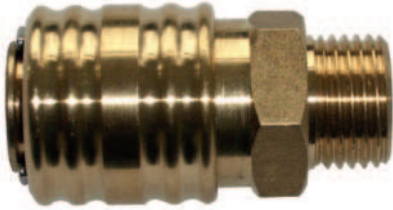

Couplings with female thread

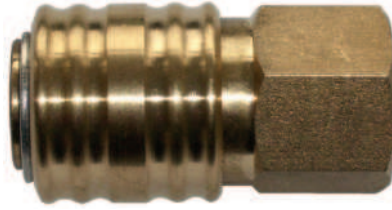

Couplings with hose stem

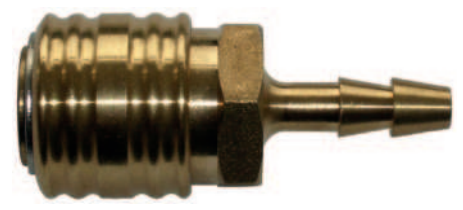

Art. No.	thread
EGKS 18 A	G 1/8"
EGKS 14 A	G 1/4"
EGKS 38 A	G 3/8"
EGKS 12 A	G 1/2"
EGKS 1415 A	M 14 x 1,5
EGKS 1615 A	M 16 x 1,5
EGKS 1815 A	M 18 x 1,5

Art. No.	thread
EGKS 18 I	G 1/8"
EGKS 14 I	G 1/4"
EGKS 38 I	G 3/8"
EGKS 12 I	G 1/2"
EGKS 1415 I	M 14 x 1,5
EGKS 1615 I	M 16 x 1,5
EGKS 1815 I	M 18 x 1,5

Art. No.	hose \varnothing (mm)
EGKS 6 T	6 mm
EGKS 8 T	8 mm
EGKS 9 T	9 mm
EGKS 10 T	10 mm
EGKS 13 T	13 mm

Standard Quick-Disconnect Couplings DN 7,2

universal quick-disconnect couplings made of brass, blank, new stem profile for safe fit of the hose and assembly

Plugs with male thread



Plugs with female thread

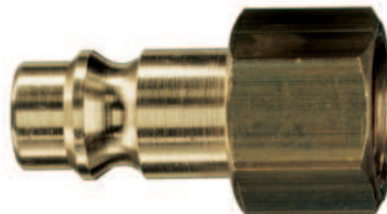

Plugs with hose stem



Art. No.	thread
EGKS 18 NA	G 1/8"
EGKS 14 NA	G 1/4"
EGKS 38 NA	G 3/8"
EGKS 12 NA	G 1/2"

Art. No.	thread
EGKS 18 NI	G 1/8"
EGKS 14 NI	G 1/4"
EGKS 38 NI	G 3/8"
EGKS 12 NI	G 1/2"

Art. No.	hose \varnothing (mm)
EGKS 6 S	6 mm
EGKS 8 S	8 mm
EGKS 9 S	9 mm
EGKS 10 S	10 mm
EGKS 13 S	13 mm

Quick Couplings

Distributors for Quick-Disconnect Couplings DN 7,2

assembled of brass MS 58, for compressed air distribution on central places

3-Way-Distributors



Art. No.	inlet G female (inch)
EGKTW 38 ES	G 3/8"
EGKTW 12 ES	G 1/2"

4-Way-Distributors



Art. No.	inlet G female (inch)
EGKFW 38 ES	G 3/8"
EGKFW 12 ES	G 1/2"

Art. No.	thread G	Pneumatic Double Nipples with male thread
185.029	1/8"-1/8"	
185.030	1/8"-1/4"	
185.033	1/4"-1/4"	
185.053	1/4"-3/8"	
185.054	1/4"-1/2"	
185.055	3/8"-3/8"	
185.075	3/8"-1/2"	
185.077	1/2"-1/2"	
185.078	1/2"-3/4"	
185.013	3/4"-3/4"	
185.015	3/4"-1"	
185.014	1"-1"	
280-228	1 1/2"-1 1/2"	
454-9	2"-2"	

Art. No.	thread G	Pneumatic Reducing Nipples with female thread, male thread and hexagon
1117	1/4"-1/8"	
322-18	3/8"-1/8"	
1068	3/8"-1/4"	
1191	1/2"-1/4"	
1018	1/2"-3/8"	
1292	3/4"-1/2"	
1193	1"-3/4"	
409-81	1 1/2"-3/4"	
417-50	2"- 1 1/4"	
417-45	2"-1 1/2"	

Pneumatic Hose Connectors DIN 8542

made of brass



Art. No.	hose \varnothing (mm) 1	hose \varnothing (mm) 2	length (mm)
113.00	4	4	64
113.01	6	6	72
113.02	6	8	72
113.03	9	9	72
113.04	13	13	72

Pneumatic-Connectors DIN 3852-2

made of brass, with male thread parallel and inner cone 45°

Art. No.	thread G (inch)	length (mm)	hose \varnothing (mm)
113-51	1/8"	37	6
113-52	1/8"	37	9
113-31a	1/4"	40	6
113-40a	1/4"	40	9
113-71	1/4"	45	13
113-32a	3/8"	43	6
113-34a	3/8"	43	9
113-43	3/8"	48	13
113-67	1/2"	44	6
113-66	1/2"	44	9
113-44	1/2"	49	13
113-25	3/4"	49	9
113-26	3/4"	54	13
113-27	3/4"	58	19



Quick Couplings

Hose Clamps DIN 20039 A

robust clamps of malleable iron, zinc plated and yellow passivated with two parts with loose saddles



Art. No.	for hose \varnothing (inch = mm)	hose outer range
SL 29	1/2" = 13 mm	22-29
SL 30	3/4" = 19 mm	28-34
SL 31	1" = 25 mm	32-40
SL 32	1.1/4" = 32 mm	39-49
SL 33	1.1/2" = 38 mm	48-60
SL 34	2" = 50 mm	56-72
SL 35	2.1/2" = 63 mm	77-94
SL 36	3" = 75 mm	89-101
SL 37	3" = 75 mm	94-115
SL 38	3.1/2" = 89 mm	113-127
SL 39	3.1/2" = 89 mm	115-145
SL 40	4" = 100 mm	127-140
SL 41	4" = 100 mm	135-155
SL 42	5" = 125 mm	155-175
SL 43	6" = 150 mm	175-195
SL 44	7" = 175 mm	210-225
SL 45	8" = 200 mm	227-250

Original Rubber Ring

made of perbunan, oil resistant



Art. No. 516-6

Claw Couplings

robust couplings of malleable iron, zinc plated and yellow passivated

Hose (formerly DIN 3483)



Art. No.	for hose \varnothing (inch = mm)
SKG 6	1/4" = 6 mm
SKG 10	3/8" = 10 mm
SKG 13	1/2" = 13 mm
SKG 15	5/8" = 15 mm
SKG 19	3/4" = 19 mm
SKG 25	1" = 25 mm
SKG 32	1.1/4" = 32 mm

Female (formerly DIN 3482)

Art. No.	thread G (inch)
KIG 14	1/4"
KIG 38	3/8"
KIG 12	1/2"
KIG 34	3/4"
KIG 10	1"
KIG 54	1.1/4"



Male (formerly DIN 3481)

Art. No.	thread G (inch)
KAG 14	1/4"
KAG 38	3/8"
KAG 12	1/2"
KAG 34	3/4"
KAG 10	1"
KAG 54	1.1/4"



Water & Air Hose Reels



Water Hose Reels WS 3220

light, practical and mobile water hose extension, special hose with textile inlay and spiral wound cross-weave, with a spraying nozzle with waterstop and a top connector, drum made of special highly breakproof plastic, strong carrying frame made of galvanized tubular steel
hose length 20m, Ø 1/2"



Art. No. 1237130



Compressor Hose Reels

with high-quality fabric hose, oil-resistant, up to 15 bar of pressure, complete with quick release couplings, drum made of special highly breakproof plastic

standard

Art. No. 1127020

frame made of steel tubing with bright galvanized zinc coating, hose length 20m, Ø 6 / 12 mm



anti twist

Art. No. 1127010 Ø 6 / 12 mm

Art. No. 1127030 Ø 9 / 15 mm

with axial connection permitting rolling up or out during operation, throughflow system, with connection hose, suitable for wall mounting, frame made of steel tubing with bright galvanized zinc coating, hose length 20m



Pressure Gauges

Pressure Gauges

plastic frame, with snap in window made of macrolon, steel casing enamelled black with 2 readings bar / psi, bottom connection

Type 50.11

Type 63.11

Type 80.18

Type 100.18



Pressure Gauges

with chrome plated ring, steel casing enamelled black with 2 readings bar / psi, bottom connection

Type 63.14

Type 80.11

Type 100.11

Type 160.11



Nominal size \varnothing mm connection	pressure range Bar / PSI	50	63	80	100
		1/4 NPT	1/4 NPT	1/2 NPT	1/2 NPT
		No.	No.	No.	No.
		50.11-...	63.11-...	80.18-...	100.18-...
0-1	0-15	1B	1B	1B	1B
0-1.6	0-25	1.6B	1.6B	1.6B	1.6B
0-2.5	0-30	2.5B	2.5B	2.5B	2.5B
0-4	0-60	4B	4B	4B	4B
0-6.8	0-100	6.8B	6.8B	6.8B	6.8B
0-10.5	0-150	10.5B	10.5B	10.5B	10.5B
0-13.5	0-200	13.5B	13.5B	13.5B	13.5B
0-17	0-250	17B	17B	17B	17B
0-21	0-300	21B	21B	21B	21B
0-24	0-350	24B	24B	24B	24B
0-27.5	0-400	27.5B	27.5B	27.5B	27.5B
0-41	0-600	41B	41B	41B	41B
0-54	0-800	54B	54B	54B	54B
0-68	0-1000	68B	68B	68B	68B
0-100	0-1500	100B	100B	100B	100B
0-140	0-2000	140B	140B	140B	140B
0-170	0-2500	170B	170B	170B	170B
0-200	0-3000	200B	200B	200B	200B
0-250	0-3500	250B	250B	250B	250B
0-315	0-4000	315B	315B	315B	315B
0-400	0-6000	400B	400B	400B	400B

Nominal size \varnothing mm connection	pressure range Bar / PSI	63	80	100	160
		1/4 NPT	1/2 NPT	1/2 NPT	1/2 NPT
		No.	No.	No.	No.
		63.14-...	80.11-...	100.11-...	160.11-...
0-1	0-15	1B	1B	1B	1B
0-1.6	0-25	1.6B	1.6B	1.6B	1.6B
0-2.5	0-30	2.5B	2.5B	2.5B	2.5B
0-4	0-60	4B	4B	4B	4B
0-6.8	0-100	6.8B	6.8B	6.8B	6.8B
0-10.5	0-150	10.5B	10.5B	10.5B	10.5B
0-13.5	0-200	13.5B	13.5B	13.5B	13.5B
0-17	0-250	17B	17B	17B	17B
0-21	0-300	21B	21B	21B	21B
0-24	0-350	24B	24B	24B	24B
0-27.5	0-400	27.5B	27.5B	27.5B	27.5B
0-41	0-600	41B	41B	41B	41B
0-54	0-800	54B	54B	54B	54B
0-68	0-1000	68B	68B	68B	68B
0-100	0-1500	100B	100B	100B	100B
0-140	0-2000	140B	140B	140B	140B
0-170	0-2500	170B	170B	170B	170B
0-200	0-3000	200B	200B	200B	200B
0-250	0-3500	250B	250B	250B	250B
0-315	0-4000	315B	315B	315B	315B
0-400	0-6000	400B	400B	400B	400B



Pressure Gauges & Test Pumps



Pressure Gauges

stainless steel casing, filled with glyzerine, stainless steel rim-sealed ring, macralon-lens, with 2 readings bar / psi



Type GL 63.13

Type GL100.13

Nominal size \varnothing mm connection	63		100	
	1/4 NPT	1/2 NPT	No. 63.14-...	No. 100.11-...
pressure range Bar / PSI			No. 63.14-...	No. 100.11-...
0-1	0-15	1B	1B	
0-1.6	0-25	1.6B	1.6B	
0-2.5	0-30	2.5B	2.5B	
0-4	0-60	4B	4B	
0-6.8	0-100	6.8B	6.8B	
0-10.5	0-150	10.5B	10.5B	
0-13.5	0-200	13.5B	13.5B	
0-17	0-250	17B	17B	
0-21	0-300	21B	21B	
0-24	0-350	24B	24B	
0-27.5	0-400	27.5B	27.5B	



Nominal size \varnothing mm connection	63		100	
	1/4 NPT	1/2 NPT	No. 63.14-...	No. 100.11-...
pressure range Bar / PSI			No. 63.14-...	No. 100.11-...
0-41	0-600	41B	41B	
0-54	0-800	54B	54B	
0-68	0-1000	68B	68B	
0-100	0-1500	100B	100B	
0-140	0-2000	140B	140B	
0-170	0-2500	170B	170B	
0-200	0-3000	200B	200B	
0-250	0-3500	250B	250B	
0-315	0-4000	315B	315B	
0-400	0-6000	400B	400B	

Hand-Operated Test Pumps with pressure gauge connection 1/2"



Art. No. specifications	HP 220	HP 300	HP 500
plunger \varnothing	22 mm	30 mm	50/16 mm
capacity/volume	15 cm ³	28 cm ³	73 cm ³
test pressure	100 bar	60 bar	200 bar
stationary type	HP 220	HP 300	HP 500
mobile type			HP 500M

Test Pumps

High Pressure Hand-Operated Test Pumps

with pressure gauge connection 1/2" and safety valve

Art. No.	HP 32/8	HP 32/12
plunger \varnothing	32/8 mm	32/12 mm
capacity/volume	28 cm ³	28 cm ³
test pressure	1000 bar	630 bar
stationary type	HP/8	HP/12
mobile type	HP/8M	HP/12M



Hand-Operated Testing Pumps with twin-valve technology

RP50

precision testing pump in monoblock design 0 - 60 bar

testing and pressure range:
 0 - 60 bar, with 1 bar steps
 0 - 860 psi, with 20 psi steps
 0 - 6 MPa, with 0,1 MPa steps
 hub suction capacity: approx. 45 ml / stroke
 tank capacity: 12 l
 connection: R 1/2"

Art. No. 6.0200

TP25

small testing pump for compression testing
 testing and pressure range:
 0 - 25 bar

hub suction capacity: approx. 16 ml / stroke
 tank capacity: 7 l
 connection: R 1/2"

Art. No. 6.0250



KISTENMACHER Testing Pump TP5

testing pump in monoblock design 0 - 60 bar,
 tank: painted in epoxy powder red colour semi-texturized
 working lever: zinc plated

manometers: 0-60 bar - 0-860 psi
 pressure gauge connection: 1/4" bsp
 outgoing pipe connection: 1/2" bsp
 hose with two connections of 1/2" bsp
 capacity: 10 l

Art. No. TP-5



Industrial Sprayers

Industrial Sprayers

PE-black double acting

atomizer head with double stroke and freely positionable
flexible hose allows almost complete emptying at a working angle of 0° - 180°
pressure spring and ball made of INOX
recommended for use with thin liquid media, such as lubricants, break cleaners
and cleaners from the industrial and automotive industry areas, as long as the
material of the sprayer is resistant to these media

colour of container: black
colour of sprayhead: black-silver

Art. No.	ml
06 232	500
06 233	750
06 235	1000



Household Sprayers

sprayer head with adjustable and closeable plastic nozzle (00 258)
water-based. non aggressive liquids

colour of container: orange
colour of sprayhead: blue-white

Art. No.	ml
06 266	500



Industrial Sprayers

suitable for various chemicals, e.g. detergents, solvents and cleaning agents
stable conical bottle design

colour of container: orange
colour of sprayhead: blue-white

Art. No.	ml	specification
06 267	750	spreayer head with adjustable and closeable plastic nozzle
06 267 956	750	sprayer head with adjustable and manual shut-off brass spray nozzle



Pressure Sprayers

GLORIA®

Hobby 05 Flex / 10 Flex

fine sprayer - double acting precision pump,
1 x pump = 2 x spray
adjustable nozzle with brass insert,
transparent level indicator,
container made of high quality plastic
360° spray function

Art. No.	capacity
Hobby 05 Flex - 850	0.5 liter
Hobby 10 Flex - 860	1.00 liter



Hobby 100 Flex / 125 Flex

pressure sprayer for homes and gardens,
operating pressure max. 3 bar,
adjustable nozzle incl. brass insert,
transparent level indicator strip,
container made of high quality plastic
powerful pressure pump

Art. No.	capacity
Hobby 100 - 15	1.0 liter
Hobby 125 Flex - 25	1.25 liter



Prima 3 / 5 / 8

high quality plastic,
powerful pressurs pump,
integral safety valve,
brass spray lance and hose,
carrying straps

Art. No.	capacity
Prima 3 - 78	3.0 liter
Prima 5 - 80	5.0 liter
Prima 8 - 99	8.0 liter with bottom ring for safe stand



Primex 5

brass extension tube (length 0.5 m)
compression fitting

Art. No. 83



- filling capacity 5.0 l / total volume 7.0 l
- maximum operating pressure 3 bar
- sturdy plastic container
- brass spray lance with adjustable brass hollow cone nozzle
- powerful pressure pump
- transparent viewing strip for fill level control
- base ring for secure standing
- portable on shoulder

Prima 5 plus

resistant to acetic acid
for application of acidic pesticides
acid-resistant EPDM seals

Art. No. 106



- filling capacity 5.0 l / total volume 7.0 l
- maximum operating pressure 3 bar
- plastic spray lance with adjustable plastic nozzle
- plastic extension tube (length 0.5 m)
- fabric-reinforced double-layer hose
- transparent viewing strip for fill level control
- portable on shoulder

Pressure Sprayers

GLORIA®

Art. No.	405 T	410 T
filling capacity	5 l	10 l
max. pressure	6 bar	6 bar
material of container	steel with high quality plastic interior coating	
pressure gauge	w/o	with
other equipment	safety relief and ventilating valve, brass spray lance, carrying strap	



405 T



410 T

Art. No.	505 T	510 T
filling capacity	5 l	10 l
max. pressure	6 bar	6 bar
material of container	stainless steel (non-corroding)	
pressure gauge	w/o	with
other equipment	safety relief and ventilating valve, brass spray lance, carrying strap	



510 T

Piston Knapsack Sprayer Typ HOBBY 1200 & HOBBY 1800

with extra filling capacity, ergonomic container, infinitely adjustable operating pressures (1-3 bar)

Art. No.	56 (Hobby 1200)	60 (Hobby 1800)
filling capacity	12 l	18 l
max. pressure	6 bar	6 bar
pressure gauge	with	with
other equipment	brass spray lance, padded shoulder straps with quick release system, carrying strap, portable on back	
		brass extension tube (length 0.5 m)



1200 Hobby



1800 Hobby

Piston Knapsack Sprayer Classic 1800

with extra filling capacity ergonomic container

Art. No.	66 (CLASSIC 1800)
filling capacity	18 l
max. pressure	4 bar
material of container	heavy duty plastic
pump	plastic pump

- filling capacity 18 l / total volume 23.3 l
- maximum operating pressure 4 bar
- brass spray lance with hollow cone nozzle
- pump lever wearable left or right side with spraying tube holder
- precise quick-acting valve
- base plinths for safe stand
- adjustable carrying straps, portable on back



Metal Tool Boxes

KISTENMACHER brand Empty Tool Boxes

made of sheet metal, hammer slag blue, with hole for locking

3-tray with 1 handle

Art. No.

430/3-1	430 x 200 x 160 mm
530/3-1	530 x 200 x 160 mm

5-tray with 1 handle

Art. No.

430/5-1	430 x 200 x 200 mm
530/5-1	530 x 200 x 200 mm

3-tray with 2 handle

Art. No.

430/3-2	430 x 200 x 160 mm
530/3-2	530 x 200 x 160 mm

5-tray with 2 handle

Art. No.

430/5-2	430 x 200 x 200 mm
530/5-2	530 x 200 x 200 mm

7-tray with 2 handle

Art. No.

430/7-2	430 x 200 x 250 mm
530/7-2	530 x 200 x 250 mm



Workshop Trolleys load capacity: 150 kg

colour: blue - other colours on request, drawers made of strong metal sheet with partitions, lockable drawers with central locking system, rubber coated top, metal body powder coated, mobile unit with 4 strong wheels (2 x swivel - 2 x fixed)

1 + 4 drawers big

trolley with 4 drawers + 1 storage compartment extractable on both sides and one extra big compartment - (easy storage for big tools)

Art. No. WST-5 750 x 400 x 870 mm



6 drawers

trolley with 6 drawers, drawers fully extractable on one side only

Art. No. WST-6 750 x 400 x 910 mm



HSS Drill Bits DIN 338 N



HSS DIN 338 N Standard Finish

Straight shank twist drill, short series, right hand, roll forged, steam tempered, 118° universal point shape, packing in plastic bags of 10 pcs (up to 8.0 mm) or 5 pcs (from 8.5 mm).



Art. No.	Ø mm
338ST00100	1.0
338ST00150	1.5
338ST00200	2.0
338ST00250	2.5
338ST00300	3.0
338ST00350	3.5
338ST00400	4.0
338ST00450	4.5
338ST00500	5.0
338ST00550	5.5
338ST00600	6.0
338ST00650	6.5
338ST00700	7.0
338ST00750	7.5
338ST00800	8.0
338ST00850	8.5
338ST00900	9.0
338ST00950	9.5
338ST01000	10.0
338ST01100	11.0
338ST01200	12.0
338ST01300	13.0
338ST01400	14.0
338ST01500	15.0
338ST01600	16.0
338ST01700	17.0
338ST01800	18.0
338ST01900	19.0
338ST02000	20.0



HSS CO DIN 338 N Cobalt Finish

Straight shank twist drill, short series, right hand, 5% Co, ground from solid, gold finish, packing in plastic bags of 10 pcs (up to 8.0 mm) or 5 pcs (from 8.5 mm).



Art. No.	Ø mm
338CO00300	3.0
338CO00350	3.5
338CO00400	4.0
338CO00450	4.5
338CO00500	5.0
338CO00550	5.5
338CO00600	6.0
338CO00650	6.5
338CO00700	7.0
338CO00750	7.5
338CO00800	8.0
338CO00850	8.5
338CO00900	9.0
338CO00950	9.5
338CO01000	10.0
338CO01100	11.0
338CO01200	12.0
338CO01300	13.0
338CO01400	14.0
338CO01500	15.0
338CO01600	16.0
338CO01700	17.0
338CO01800	18.0
338CO01900	19.0
338CO02000	20.0



Inch sizes are available upon request!

HSS Drill Bits DIN 345 N + DIN 340 N long



HSS DIN 345 N

Morse taper shank twist drill, right hand, steam tempered, 118° split point, individually packed in plastic tubes



Art. No.	Ø mm	Art. No.	Ø mm	Art. No.	Ø mm
345ST01000	10.0	345ST02500	25.0	345ST04000	40.0
345ST01050	10.5	345ST02550	25.5	345ST04500	40.5
345ST01100	11.0	345ST02600	26.0	345ST04100	41.0
345ST01150	11.5	345ST02650	26.5	345ST04150	41.5
345ST01200	12.0	345ST02700	27.0	345ST04200	42.0
345ST01250	12.5	345ST02750	27.5	345ST04250	42.5
345ST01300	13.0	345ST02800	28.0	345ST04300	43.0
345ST01350	13.5	345ST02850	28.5	345ST04350	43.5
345ST01400	14.0	345ST02900	29.0	345ST04400	44.0
345ST01450	14.5	345ST02950	29.5	345ST04450	44.5
345ST01500	15.0	345ST03000	30.0	345ST04500	45.0
345ST01550	15.5	345ST03050	30.5	345ST04550	45.5
345ST01600	16.0	345ST03100	31.0	345ST04600	46.0
345ST01650	16.5	345ST03150	31.5	345ST04650	46.5
345ST01700	17.0	345ST03200	32.0	345ST04700	47.0
345ST01750	17.5	345ST03250	32.5	345ST04750	47.5
345ST01800	18.0	345ST03300	33.0	345ST04800	48.0
345ST01850	18.5	345ST03350	33.5	345ST04850	48.5
345ST01900	19.0	345ST03400	34.0	345ST04900	49.0
345ST01950	19.5	345ST03450	34.5	345ST04950	49.5
345ST02000	20.0	345ST03500	35.0	345ST05000	50.0
345ST02050	20.5	345ST03550	35.5	345ST05100	51.0
345ST02100	21.0	345ST03600	36.0	345ST05200	52.0
345ST02150	21.5	345ST03650	36.5	345ST05300	53.0
345ST02200	22.0	345ST03700	37.0	345ST05400	54.0
345ST02250	22.5	345ST03750	37.5	345ST05500	55.0
345ST02300	23.0	345ST03800	38.0	345ST05600	56.0
345ST02350	23.5	345ST03850	38.5	345ST05700	57.0
345ST02400	24.0	345ST03900	39.0	345ST05800	58.0
345ST02450	24.5	345ST03950	39.5	345ST05900	59.0
				345ST06000	60.0

HSS DIN 340 N Long Series

Straight shank twist drill, right hand, roll forged, steam tempered, 118° universal point shape, packing in plastic bags of 10 pcs



Art. No.	Ø mm
340ST00300	3.0
340ST00350	3.5
340ST00400	4.0
340ST00450	4.5
340ST00500	5.0
340ST00550	5.5
340ST00600	6.0
340ST00650	6.5
340ST00700	7.0
340ST00750	7.5
340ST00800	8.0
340ST00850	8.5
340ST00900	9.0
340ST00950	9.5
340ST01000	10.0
340ST01100	11.0
340ST01200	12.0
340ST01300	13.0
340ST01400	14.0
340ST01500	15.0
340ST01600	16.0
340ST01700	17.0
340ST01800	18.0
340ST01900	19.0
340ST02000	20.0



HSS Tin Drills, Drills with reduced shank, Drill Bits for Glass



KISTENMACHER brand HSS TIN Twist Drill Bit DIN 338

straight shank, short series, for stainless steel, right hand, ground from solid, coated, gold finish, from size 4.0 mm with laser printing „Made in Germany“, each piece in a black/red plastic wallet

Art. No.	Ø mm
338TIN00100T	1.0
338TIN00200T	2.0
338TIN00300T	3.0
338TIN00400T	4.0
338TIN00500T	5.0
338TIN00600T	6.0
338TIN00800T	8.0
338TIN01000T	10.0
338TIN01200T	12.0



KISTENMACHER brand HSS Twist Drill Bit DIN 338

short series, right hand, reduced shank to diam. 13 mm, with laser printing „Made in Germany“, each piece in a plastic bag with orange sticker



Art. No.	Ø mm	Art. No.	Ø mm
338RE01400	14.0	338RE02150	21.5
338RE01450	14.5	338RE02200	22.0
338RE01500	15.0	338RE02400	24.0
338RE01550	15.5	338RE02450	24.5
338RE01600	16.0	338RE02500	25.0
338RE01700	17.0	338RE02600	26.0
338RE01800	18.0	338RE02700	27.0
338RE01900	19.0	338RE02800	28.0
338RE02000	20.0	338RE03000	30.0
338RE02100	21.0		

Glass Drill Bit, hex. shank

galvanized surface, precision diamond ground TC tip, suitable for drilling in plate glass, glass panes, bottle glass, tiles and ceramics

individually packed in PVC wallet



Art. No.	Ø mm
9500T 032	3.2
9500T 042	4.2
9500T 052	5.2
9500T 062	6.2
9500T 072	7.2
9500T 082	8.2
9500T 092	9.2
9500T 102	10.2
9500T 122	12.2
9500T 132	13.2



HSS Drill Bit Sets DIN 338



KISTENMACHER brand HSS DIN 338 drill bit set in plastic box

straight shank twist drill, short series, right hand, roll forged, steam tempered, 118° universal point shape, packed in plastic box



Art. No.	pcs/set	mm/inch	sizes
338SET6106	6	mm	2, 3, 4, 5, 6, 8
338SET2100	10	mm	1, 2, 3, 4, 5, 6, 7, 8, 9, 10
338SET2113	13	mm	1.5, 2, 2.5, 3, 3.2, 3.5, 4, 4.5, 4.8, 5, 5.5, 6, 6.5
338SET2119	19	mm	1, 1.5, 2, 2.5, 3, 3.5, 4, 4.5, 5, 5.5, 6, 6.5, 7, 7.5, 8, 8.5, 9, 9.5, 10
338SET2191	7	inch	1/16, 3/32, 1/8, 5/32, 3/16, 7/32, 1/4
338SET2193	13	inch	1/16, 5/64, 3/32, 7/64, 1/8, 9/64, 5/32, 11/64, 3/16, 13/64, 7/32, 15/64, 1/4
338SET2192	10	inch	1/16 - 1/4 1/64 missing, without 11/64, 13/64, 15/64

KISTENMACHER brand HSS DIN 338 drill bit set in metal box

straight shank twist drill, short series, right hand, roll forged, steam tempered, 118° universal point shape, packed in metal box



Art. No.	pcs/set	mm/inch	sizes
338SET2519	19	mm	1, 1.5, 2, 2.5, 3, 3.5, 4, 4.5, 5, 5.5, 6, 6.5, 7, 7.5, 8, 8.5, 9, 9.5, 10
338SET2525	25	mm	1, 1.5, 2, 2.5, 3, 3.5, 4, 4.5, 5, 5.5, 6, 6.5, 7, 7.5, 8, 8.5, 9, 9.5, 10, 10.5, 11, 11.5, 12.0, 12.5, 13
338SET0273	21	inch	1/16, 5/64, 3/32, 7/64, 1/8, 9/64, 5/32, 11/64, 3/16, 13/64, 7/32, 15/64, 1/4, 17/64, 9/32, 19/64, 5/16, 21/64, 11/32, 23/64, 3/8
338SET0274	29	inch	1/16, 5/64, 3/32, 7/64, 1/8, 9/64, 5/32, 11/64, 3/16, 13/64, 7/32, 15/64, 1/4, 17/64, 9/32, 19/64, 5/16, 21/64, 11/32, 23/64, 3/8, 25/64, 13/32, 27/64, 7/16, 29/64, 15/32, 31/64, 1/2

Mortise Bits, Screw Extractors & Single Cutter

KISTENMACHER brand Screw Extractor sets

packing in plastic box - two options



Art. No.	size	pcs / set
5015 (AB-A)	1 to 5	5 pcs set
5016 (AB-B)	1 to 6	6 pcs set
5018 (AB-C)	1 to 8	8 pcs set

Single flute cutter HSS-E

for slotting and drilling in Aluminium- and UPVC-profiles

- used on copyrouters, drainage slot routers and CNC-machining-centres:
AFS, BJM, elumatec, Emmegi, FOM, Haffner, KABAN, MLA, Kombimatec, Perti, Pressta-Eisele, Rapid, Rotox, Schirmer, Striffler, TEKNA, Thorwesten, Wegoma etc.
- speed approx. 8.000 - 20.000 rpm
- direct and adequate cooling-spray is particularly important for aluminium working !

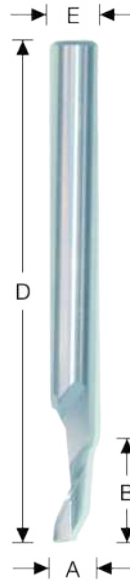

Art. No.	A	B	D	E
060 008 004	4	12	60	8
080 008 004	4	12	80	8
011 008 004	4	40	100	8
060 008 005	5	12	60	8
080 008 355	5	35	80	8
010 008 145	5	14	100	8
060 008 006	6	14	60	8
080 008 256	6	25	80	8
011 008 006	6	40	100	8

Mortise Bits (No. 395)

with double cutter and chip breaking grooves - cylindrical shank for use in bushing for right and left hand

- A) right cutting** - shaft 16 x 50 mm
- B) left cutting** - shaft 16 x 50 mm
- C) right cutting** - shaft 13 x 50 mm
- D) left cutting** - shaft 13 x 50 mm



Art. No.	Art. No.	Art. No.	Art. No.	size/length (mm)
A	B	C	D	
395/16/6r	395/16/6l	395/13/6r	395/13/6l	6 x 120
395/16/7r	395/16/7l	395/13/7r	395/13/7l	7 x 125
395/16/8r	395/16/8l	395/13/8r	395/13/8l	8 x 130
395/16/9r	395/16/9l	395/13/9r	395/13/9l	9 x 135
395/16/10r	395/16/10l	395/13/10r	395/13/10l	10 x 140
395/16/11r	395/16/11l	395/13/11r	395/13/11l	11 x 145
395/16/12r	395/16/12l	395/13/12r	395/13/12l	12 x 150
395/16/13r	395/16/13l	395/13/13r	395/13/13l	13 x 155
395/16/14r	395/16/14l	395/13/14r	395/13/14l	14 x 160
395/16/15r	395/16/15l	395/13/15r	395/13/15l	15 x 165
395/16/16r	395/16/16l	395/13/16r	395/13/16l	16 x 170
395/16/18r	395/16/18l	395/13/18r	395/13/18l	18 x 180
395/16/20r	395/16/20l	395/13/20r	395/13/20l	20 x 185
395/16/22r	395/16/22l	395/13/22r	395/13/22l	22 x 195
395/16/24r	395/16/24l	395/13/24r	395/13/24l	24 x 200
395/16/26r	395/16/26l	395/13/26r	395/13/26l	26 x 210
395/16/30r	395/16/30l	395/13/30r	395/13/30l	30 x 220

Countersink - Step Drills



Precision - Countersink, HSS
solid carbide similar DIN 335 C 90 degrees

3-cutting edges-geometry
we recommend HM-countersinks when machining tough materials, high-strength steels, titanium or titanium-alloy



Art. No.	Ø head (mm)	shank (mm)	length (mm)	smallest Ø (mm)	Art. No.	Ø head (mm)	shank (mm)	length (mm)	smallest Ø (mm)	Art. No.	Ø head (mm)	shank (mm)	length (mm)	smallest Ø (mm)
1030043	4,3	4	40	1,3	1030094	9,4	6	50	2,2	1030205	20,5	10	67	3,8
1030050	5,0	4	40	1,5	1030100	10,0	6	50	2,5	1030250	23,0	10	67	3,8
1030053	5,3	4	40	1,5	1030104	10,4	6	50	2,5	1030260	26,0	10	67	3,8
1030058	5,8	5	45	1,5	1030115	11,5	8	56	2,8	1030280	28,0	12	71	4,0
1030060	6,0	5	45	1,5	1030124	12,4	8	56	2,8	1030300	30,0	12	71	4,2
1030063	6,3	5	45	1,5	1030134	13,4	8	56	2,9	1030310	31,0	12	71	4,2
1030070	7,0	6	50	1,8	1030144	14,4	10	60	3,2	1030400	40,0	13	80	6,5
1030073	7,3	6	50	1,8	1030150	15,0	10	60	3,2	1030500	50,0	13	85	12,0
1030080	8,0	6	50	2,0	1030165	16,5	10	60	3,2					
1030083	8,3	6	50	2,0	1030190	19,0	10	63	3,5					

Precision - Countersink HSS Set
solid carbide similar DIN 335 C 90 degrees

3-cutting edges-geometry
we recommend HM-countersinks when machining tough materials, high-strength steels, titanium or titanium-alloy

Art. No.	pcs per set	range Ø (mm)	sizes
1030001	6	6,0 - 19,0	6,0 - 8,0 - 10,0 - 11,5 - 15,0 - 19,0 mm
1030002	6	6,3 - 20,5	6,3 - 8,3 - 10,4 - 12,4 - 16,5 - 20,5 mm
1030003	7	6,3 - 25,0	6,3 - 8,3 - 10,4 - 12,4 - 16,5 - 20,5 - 25,0 mm
1030004	7	6,0 - 25,0	6,0 - 8,0 - 10,0 - 11,5 - 15,0 - 19,0 - 25,0 mm



Precision - HSS Countersink, 1/4" hexagon shank
solid carbide similar DIN 3126 C 6,3 90 degrees
deburring bits for metal, plastic and timber

Art. No.	drill-range	shank	mm
1570/8	8 mm	4 mm	37
1570/10	10 mm	5 mm	41
1570/12	12 mm	6 mm	45
1570/16	16 mm	8 mm	49
1570/20	20 mm	10 mm	50



Precision - HSS Step Drill 2mm rising
2-cutting edges-geometry, straight fluted

Art. No.	drill-range	shank	mm	steps
1140411	4 - 12 mm	6 mm	62	5
1140420	4 - 20 mm	8 mm	73	9
1140630	6 - 30 mm	10 mm	95	13



HSS Core Drills

ALFRA - Rotabest - HSS BASIC CORE DRILLS

with weldon shank 19.0 mm, 2 driving surfaces,
internal bore 6.35 mm
special super high speed steel
polished section: pre- and post cutter



Art. No.	cutting depth	dia.	Art. No.	cutting depth	dia.
1907012025	30 mm	12 mm	1907033025	30 mm	33 mm
1907013025	30 mm	13 mm	1907034025	30 mm	34 mm
1907014025	30 mm	14 mm	1907035025	30 mm	35 mm
1907015025	30 mm	15 mm	1907036025	30 mm	36 mm
1907016025	30 mm	16 mm	1907037025	30 mm	37 mm
1907017025	30 mm	17 mm	1907038025	30 mm	38 mm
1907018025	30 mm	18 mm	1907039025	30 mm	39 mm
1907019025	30 mm	19 mm	1907040025	30 mm	40 mm
1907020025	30 mm	20 mm	1907041025	30 mm	41 mm
1907021025	30 mm	21 mm	1907042025	30 mm	42 mm
1907022025	30 mm	22 mm	1907043025	30 mm	43 mm
1907023025	30 mm	23 mm	1907044025	30 mm	44 mm
1907024025	30 mm	24 mm	1907045025	30 mm	45 mm
1907025025	30 mm	25 mm	1907046025	30 mm	46 mm
1907026025	30 mm	26 mm	1907047025	30 mm	47 mm
1907027025	30 mm	27 mm	1907048025	30 mm	48 mm
1907028025	30 mm	28 mm	1907049025	30 mm	49 mm
1907029025	30 mm	29 mm	1907050025	30 mm	50 mm
1907030025	30 mm	30 mm	1907052025	30 mm	52 mm
1907031025	30 mm	31 mm	1907055025	30 mm	55 mm
1907032025	30 mm	32 mm	1907060025	30 mm	60 mm

Art. No.	cutting depth	dia.	Art. No.	cutting depth	dia.
1907012050	50 mm	12 mm	1907037050	50 mm	37 mm
1907013050	50 mm	13 mm	1907038050	50 mm	38 mm
1907014050	50 mm	14 mm	1907039050	50 mm	39 mm
1907015050	50 mm	15 mm	1907040050	50 mm	40 mm
1907016050	50 mm	16 mm	1907041050	50 mm	41 mm
1907017050	50 mm	17 mm	1907042050	50 mm	42 mm
1907018050	50 mm	18 mm	1907043050	50 mm	43 mm
1907019050	50 mm	19 mm	1907044050	50 mm	44 mm
1907020050	50 mm	20 mm	1907045050	50 mm	45 mm
1907021050	50 mm	21 mm	1907046050	50 mm	46 mm
1907022050	50 mm	22 mm	1907047050	50 mm	47 mm
1907023050	50 mm	23 mm	1907048050	50 mm	48 mm
1907024050	50 mm	24 mm	1907049050	50 mm	49 mm
1907025050	50 mm	25 mm	1907050050	50 mm	50 mm
1907026050	50 mm	26 mm	1907051050	50 mm	51 mm
1907027050	50 mm	27 mm	1907052050	50 mm	52 mm
1907028050	50 mm	28 mm	1907053050	50 mm	53 mm
1907029050	50 mm	29 mm	1907054050	50 mm	54 mm
1907030050	50 mm	30 mm	1907055050	50 mm	55 mm
1907031050	50 mm	31 mm	1907056050	50 mm	56 mm
1907032050	50 mm	32 mm	1907057050	50 mm	57 mm
1907033050	50 mm	33 mm	1907058050	50 mm	58 mm
1907034050	50 mm	34 mm	1907059050	50 mm	59 mm
1907035050	50 mm	35 mm	1907060050	50 mm	60 mm
1907036050	50 mm	36 mm			



Art. No. ejector pin
1926500 6.35 x 77 mm



Art. No. ejector pin
1950500 6.35 x 102 mm

TCT Core Drills

ALFRA - Rotabest - TCT CORE DRILLS

with weldon shank 19.0 mm

internal bore: Ø 14 - 17 mm = 6.35 mm

Ø 18 - 50 mm = 8.0 mm

polished section: pre - middle - post cutter

for the highest standards in cutting and lifespan



Art. No.	cutting depth	dia.
2003014035	35 mm	14 mm
2003015035	35 mm	15 mm
2003016035	35 mm	16 mm
2003017035	35 mm	17 mm
2003018035	35 mm	18 mm
2003019035	35 mm	19 mm
2003020035	35 mm	20 mm
2003021035	35 mm	21 mm
2003022035	35 mm	22 mm
2003023035	35 mm	23 mm
2003024035	35 mm	24 mm
2003025035	35 mm	25 mm
2003026035	35 mm	26 mm
2003027035	35 mm	27 mm
2003028035	35 mm	28 mm
2003029035	35 mm	29 mm
2003030035	35 mm	30 mm
2003031035	35 mm	31 mm
2003032035	35 mm	32 mm
2003033035	35 mm	33 mm
2003034035	35 mm	34 mm
2003035035	35 mm	35 mm

Art. No.	cutting depth	dia.
2003014050	50 mm	14 mm
2003015050	50 mm	15 mm
2003016050	50 mm	16 mm
2003017050	50 mm	17 mm
2003018050	50 mm	18 mm
2003019050	50 mm	19 mm
2003020050	50 mm	20 mm
2003021050	50 mm	21 mm
2003022050	50 mm	22 mm
2003023050	50 mm	23 mm
2003024050	50 mm	24 mm
2003025050	50 mm	25 mm
2003026050	50 mm	26 mm
2003027050	50 mm	27 mm
2003028050	50 mm	28 mm
2003029050	50 mm	29 mm
2003030050	50 mm	30 mm
2003031050	50 mm	31 mm
2003032050	50 mm	32 mm

Art. No.	cutting depth	dia.
2003033050	50 mm	33 mm
2003034050	50 mm	34 mm
2003035050	50 mm	35 mm
2003036050	50 mm	36 mm
2003037050	50 mm	37 mm
2003038050	50 mm	38 mm
2003039050	50 mm	39 mm
2003040050	50 mm	40 mm
2003041050	50 mm	41 mm
2003042050	50 mm	42 mm
2003043050	50 mm	43 mm
2003044050	50 mm	44 mm
2003045050	50 mm	45 mm
2003046050	50 mm	46 mm
2003047050	50 mm	47 mm
2003048050	50 mm	48 mm
2003049050	50 mm	49 mm
2003050050	50 mm	50 mm



Art. No.	ejector pin
1935500	for Ø 14 - 17 mm, 6.35 x 87 mm
2001500	for Ø 18 - 50 mm, 8 x 87 mm



Art. No.	ejector pin
1950500	for Ø 14 - 17 mm, 6.35 x 102 mm
2001501	for Ø 18 - 50 mm, 8 x 102 mm

HSS Core Drills

ALFRA - Rotabest - HSS-Co-ECO CORE DRILLS

with weldon shank 19.0 mm, 2 driving surfaces,
internal bore 6.35 mm
cutting depth Ø 110 mm: 8 mm
special super high speed steel cobalt
polished section: pre- and post cutter



Art. No.	cutting depth	dia.	Art. No.	cutting depth	dia.
1901012025	30 mm	12 mm	1901033025	30 mm	33 mm
1901013025	30 mm	13 mm	1901034025	30 mm	34 mm
1901014025	30 mm	14 mm	1901035025	30 mm	35 mm
1901015025	30 mm	15 mm	1901036025	30 mm	36 mm
1901016025	30 mm	16 mm	1901037025	30 mm	37 mm
1901017025	30 mm	17 mm	1901038025	30 mm	38 mm
1901018025	30 mm	18 mm	1901039025	30 mm	39 mm
1901019025	30 mm	19 mm	1901040025	30 mm	40 mm
1901020025	30 mm	20 mm	1901041025	30 mm	41 mm
1901021025	30 mm	21 mm	1901042025	30 mm	42 mm
1901022025	30 mm	22 mm	1901043025	30 mm	43 mm
1901023025	30 mm	23 mm	1901044025	30 mm	44 mm
1901024025	30 mm	24 mm	1901045025	30 mm	45 mm
1901025025	30 mm	25 mm	1901046025	30 mm	46 mm
1901026025	30 mm	26 mm	1901047025	30 mm	47 mm
1901027025	30 mm	27 mm	1901048025	30 mm	48 mm
1901028025	30 mm	28 mm	1901049025	30 mm	49 mm
1901029025	30 mm	29 mm	1901050025	30 mm	50 mm
1901030025	30 mm	30 mm	1901052025	30 mm	52 mm
1901031025	30 mm	31 mm	1901055025	30 mm	55 mm
1901032025	30 mm	32 mm	1901060025	30 mm	60 mm

Art. No.	cutting depth	dia.	Art. No.	cutting depth	dia.
1901012050	50 mm	12 mm	1901037050	50 mm	37 mm
1901013050	50 mm	13 mm	1901038050	50 mm	38 mm
1901014050	50 mm	14 mm	1901039050	50 mm	39 mm
1901015050	50 mm	15 mm	1901040050	50 mm	40 mm
1901016050	50 mm	16 mm	1901041050	50 mm	41 mm
1901017050	50 mm	17 mm	1901042050	50 mm	42 mm
1901018050	50 mm	18 mm	1901043050	50 mm	43 mm
1901019050	50 mm	19 mm	1901044050	50 mm	44 mm
1901020050	50 mm	20 mm	1901045050	50 mm	45 mm
1901021050	50 mm	21 mm	1901046050	50 mm	46 mm
1901022050	50 mm	22 mm	1901047050	50 mm	47 mm
1901023050	50 mm	23 mm	1901048050	50 mm	48 mm
1901024050	50 mm	24 mm	1901049050	50 mm	49 mm
1901025050	50 mm	25 mm	1901050050	50 mm	50 mm
1901026050	50 mm	26 mm	1901051050	50 mm	51 mm
1901027050	50 mm	27 mm	1901052050	50 mm	52 mm
1901028050	50 mm	28 mm	1901053050	50 mm	53 mm
1901029050	50 mm	29 mm	1901054050	50 mm	54 mm
1901030050	50 mm	30 mm	1901055050	50 mm	55 mm
1901031050	50 mm	31 mm	1901056050	50 mm	56 mm
1901032050	50 mm	32 mm	1901057050	50 mm	57 mm
1901033050	50 mm	33 mm	1901058050	50 mm	58 mm
1901034050	50 mm	34 mm	1901059050	50 mm	59 mm
1901035050	50 mm	35 mm	1901060050	50 mm	60 mm
1901036050	50 mm	36 mm			



Art. No.	ejector pin
1926500	6.35 x 77 mm



Art. No.	ejector pin
1950500	6.35 x 102 mm

Masonry Drill Bits

Masonry Drill Bit DIN 8039

Masonry drill, sandblasted, tungsten carbide tip, rolled flute, for rotary and percussion, individually packed in PVC wallet



Art. No. standard length	Ø mm	Art. No. 150 mm length	Ø mm
3000T 030	3.0	3150T 050	5.0
3000T 040	4.0	3150T 055	5.5
3000T 050	5.0	3150T 060	6.0
3000T 055	5.5	3150T 065	6.5
3000T 060	6.0	3150T 070	7.0
3000T 065	6.5	3150T 080	8.0
3000T 070	7.0	3150T 100	10.0
3000T 080	8.0		
3000T 090	9.0		
Art. No. 200 mm length	Ø mm		
3000T 100	10.0		
3000T 110	11.0	3200T 050	5.0
3000T 120	12.0	3200T 055	5.5
3000T 130	13.0	3200T 060	6.0
3000T 140	14.0	3200T 065	6.5
3000T 150	15.0	3200T 070	7.0
3000T 160	16.0	3200T 080	8.0
3000T 180	18.0	3200T 100	10.0
3000T 200	20.0	3200T 110	11.0
3000T 220	22.0	3200T 120	12.0
3000T 240	24.0	3200T 130	13.0
3000T 250	25.0	3200T 140	14.0
		3200T 150	15.0
		3200T 160	16.0



Masonry Drill Bit Long Version

Masonry drill, sandblasted, high temperature carbide tip, rolled flute, for rotary and percussion, individually packed in PVC wallet



available in 400 mm and 600 mm length

Art. No. 400 mm length	Ø mm	Art. No. 600 mm	Ø mm
4800T 060	6.0		
4800T 065	6.5		
4800T 080	8.0	4900T 080	8.0
4800T 100	10.0	4900T 100	10.0
4800T 120	12.0	4900T 120	12.0
4800T 130	13.0	4900T 130	13.0
4800T 140	14.0	4900T 140	14.0
4800T 150	15.0	4900T 150	15.0
4800T 160	16.0	4900T 160	16.0
4800T 180	18.0	4900T 180	18.0
4800T 190	19.0	4900T 190	19.0
4800T 200	20.0	4900T 200	20.0
4800T 220	22.0	4900T 220	22.0
4800T 240	24.0	4900T 240	24.0
4800T 250	25.0	4900T 250	25.0
4800T 260	26.0	4900T 260	26.0
4800T 280	28.0	4900T 280	28.0
4800T 300	30.0	4900T 300	30.0
4800T 320	32.0	4900T 320	32.0



Concrete & Granite Drill Bits



Concrete (SAPHIR)

Masonry drill for percussion, high temperature brazed tungsten carbide tip, sand blasted, for concrete, natural stone, brick and marble; individually packed in PVC wallet



Art. No. standard length	Ø mm	Art. No. 200 mm length	Ø mm
3500T 030	3.0		
3500T 040	4.0		
3500T 050	5.0	3520T 050	5.0
3500T 055	5.5		
3500T 060	6.0	3520T 060	6.0
3500T 065	6.5	3520T 065	6.5
3500T 070	7.0	3520T 070	7.0
3500T 080	8.0	3520T 080	8.0
3500T 090	9.0		
3500T 100	10.0	3520T 100	10.0
		3520T 110	11.0
3500T 120	12.0	3520T 120	12.0
3500T 130	13.0	3520T 130	13.0
3500T 140	14.0	3520T 140	14.0
3500T 150	15.0	3520T 150	15.0
3500T 160	16.0	3520T 160	16.0
3500T 180	18.0		
3500T 200	20.0		
3500T 220	22.0		
3500T 240	24.0		
3500T 250	25.0		



Art. No. 150 mm extra long	Ø mm
3510T 050	5.0
3510T 060	6.0
3510T 065	6.5
3510T 070	7.0
3510T 080	8.0
3510T 100	10.0

Granite (RUBIN)

Heavy duty hammer drill, high temperature brazed tungsten carbide tip, precision milled bicolor finish, for granite, marble and concrete; individually packed in PVC wallet



Art. No. standard length	Ø mm	Art. No. 200 mm extra long	Ø mm
3400T 030	3.0	3420T 050	5.0
3400T 040	4.0	3420T 060	6.0
3400T 050	5.0	3420T 065	6.5
3400T 055	5.5	3420T 070	7.0
3400T 060	6.0	3420T 080	8.0
3400T 065	6.5	3420T 100	10.0
3400T 070	7.0	3420T 110	11.0
3400T 080	8.0	3420T 120	12.0
3400T 090	9.0	3420T 130	13.0
3400T 100	10.0	3420T 140	14.0
3400T 110	11.0	3420T 150	15.0
3400T 120	12.0	3420T 160	16.0
3400T 130	13.0		
3400T 140	14.0		
3400T 150	15.0		
3400T 160	16.0		
3400T 180	18.0		

Art. No. 150 mm extra long	Ø mm
3415T 050	5.0
3415T 060	6.0
3415T 065	6.5
3415T 070	7.0
3415T 080	8.0
3415T 100	10.0



Drill Bit Sets



Masonry Drill Bit Sets, sand blasted

each set packed in plastic box

Art. No.	pcs/set	mm	Sizes
1 3151	4	mm	4, 5, 6, 8
1 3152	4	mm	5, 6, 8, 10
1 3153	5	mm	4, 5, 6, 7, 8
1 3154	5	mm	4, 5, 6, 8, 10
1 3100	8	mm	3, 4, 5, 6, 7, 8, 9, 10



Combi Drill Bit Sets

each set packed in plastic box

Art. No.	pcs/set	mm	Sizes HSS	sizes stone (sandblasted)	sizes wood
300.190.180	9	mm	5, 6, 8	5, 6, 8	5, 6, 8



Machine Wood Working Drill Bit Sets

each set in multipack

Art. No.	pcs/set	mm	Sizes
180.350.410	5	mm	4, 5, 6, 8, 10
180.370.310	7	mm	3, 4, 5, 6, 7, 8, 10

KISTENMACHER brand Universal Drill Sets - SAPHIR

for percussion, concrete, marble, each set in plastic box

Art. No.	pcs/set	mm	Sizes
3518-3	4	mm	5,6,8,10
3518-2	5	mm	4,5,6,8,10
3518-1	7	mm	4,5,6,7,8,9,10



KISTENMACHER brand Universal Drill Sets - RUBIN

for percussion, granite, marble, each set in plastic box

Art. No.	pcs/set	mm	Sizes
3434153	4	mm	5, 6, 8, 10
3434163	5	mm	4, 5, 6, 8, 10
3418-1	7	mm	4, 5, 6, 7, 8, 9, 10



SDS Drill Sets



KISTENMACHER brand SDS PLUS Rotary Hammer Drill Bit

with 2 flutes, each piece on a plastic clip hanger
(optionally in PVC wallet)
Art. No. **3800H**



Art. No.	Ø mm length	Art. No.	Ø mm length	Art. No.	Ø mm length
3800H 4 x 110	4 x 110	3800H 10 x 260	10 x 260	3800H 16 x 200	16 x 200
3800H 4 x 160	4 x 160	3800H 10 x 310	10 x 310	3800H 16 x 260	16 x 260
3800H 5 x 110	5 x 110	3800H 10 x 350	10 x 350	3800H 16 x 300	16 x 300
3800H 5 x 160	5 x 160	3800H 10 x 460	10 x 460	3800H 16 x 450	16 x 450
3800H 5 x 210	5 x 210	3800H 10 x 600	10 x 600	3800H 16 x 600	16 x 600
3800H 5 x 310	5 x 310	3800H 11 x 160	11 x 160	3800H 18 x 200	18 x 200
3800H 6 x 110	6 x 110	3800H 11 x 210	11 x 210	3800H 18 x 250	18 x 250
3800H 6 x 160	6 x 160	3800H 12 x 160	12 x 160	3800H 18 x 300	18 x 300
3800H 6 x 210	6 x 210	3800H 12 x 200	12 x 200	3800H 18 x 450	18 x 450
3800H 7 x 110	7 x 110	3800H 12 x 260	12 x 260	3800H 18 x 600	18 x 600
3800H 7 x 160	7 x 160	3800H 12 x 300	12 x 300	3800H 19 x 200	19 x 200
3800H 7 x 210	7 x 210	3800H 12 x 450	12 x 450	3800H 20 x 200	20 x 200
3800H 8 x 110	8 x 110	3800H 12 x 600	12 x 600	3800H 20 x 300	20 x 300
3800H 8 x 160	8 x 160	3800H 13 x 160	13 x 160	3800H 20 x 450	20 x 450
3800H 8 x 210	8 x 210	3800H 13 x 200	13 x 200	3800H 20 x 600	20 x 600
3800H 8 x 260	8 x 260	3800H 13 x 260	13 x 260	3800H 20 x 1000	20 x 1000
3800H 8 x 310	8 x 310	3800H 13 x 450	13 x 450	3800H 22 x 250	22 x 250
3800H 8 x 460	8 x 460	3800H 14 x 160	14 x 160	3800H 22 x 300	22 x 300
3800H 9 x 160	9 x 160	3800H 14 x 200	14 x 200	3800H 22 x 450	22 x 450
3800H 9 x 210	9 x 210	3800H 14 x 260	14 x 260	3800H 22 x 600	22 x 600
3800H 9 x 260	9 x 260	3800H 14 x 300	14 x 300	3800H 24 x 250	24 x 250
3800H 9 x 310	9 x 310	3800H 14 x 450	14 x 450	3800H 24 x 450	24 x 450
3800H 9 x 410	9 x 410	3800H 14 x 600	14 x 600	3800H 25 x 250	19 x 200
3800H 10 x 110	10 x 110	3800H 15 x 160	15 x 160	3800H 25 x 450	19 x 200
3800H 10 x 160	10 x 160	3800H 15 x 260	15 x 260	3800H 26 x 450	26 x 450
3800H 10 x 210	10 x 210	3800H 16 x 160	16 x 160	3800H 30 x 450	30 x 450



KISTENMACHER brand SDS 4PLUS Rotary Hammer Drill Bit

with 4 flutes, each piece on a plastic clip hanger
(optionally in PVC wallet)



Art. No. **3800H4**

Art. No.	Ø mm length	Art. No.	Ø mm length	Art. No.	Ø mm length
3800H4 5 x 110	5 x 110	3800H4 8 x 160	8 x 160	3800H4 10 x 310	10 x 310
3800H4 5 x 160	5 x 160	3800H4 8 x 210	8 x 210	3800H4 10 x 460	10 x 460
3800H4 5 x 210	5 x 210	3800H4 8 x 260	8 x 260	3800H4 12 x 160	12 x 160
3800H4 6 x 110	6 x 110	3800H4 8 x 310	8 x 310	3800H4 12 x 210	12 x 210
3800H4 6 x 160	6 x 160	3800H4 8 x 460	8 x 460	3800H4 12 x 260	12 x 260
3800H4 6 x 210	6 x 210	3800H4 10 x 160	10 x 160	3800H4 12 x 310	12 x 310
3800H4 6 x 260	6 x 260	3800H4 10 x 210	10 x 210	3800H4 12 x 450	12 x 450
3800H4 8 x 110	8 x 110	3800H4 10 x 260	10 x 260		

SDS plus - SDS max Accessories

SDS PLUS Chisel, sandblasted

for rotary hammer drills with SDS-plus chuck

Pointed

Art. No. 3801H 250 mm



Flat

Art. No. 3802H 250 mm
20 mm width



Concrete Core Cutter - SDS - max shank

for rotary hammer drills weighing 5 kg or more with SDS-max or 2-slot chuck; simple and efficient handling due to one-piece tool design, chuck of adapters and centring drills is no longer necessary



Art. No.	Ø mm	length (mm)	Art. No.	Ø mm	length (mm)
7330	40	310	7343	55	990
7331	40	550	7338	65	310
7332	45	310	7339	65	550
7333	45	550	7344	65	990
7342	45	990	7340	80	310
7336	55	310	7341	80	550
7337	55	550	7345	80	990



Hollow Hammer Core Bit

with integrated SDS-max shank and centering drill bit taper 1:20 for rotary hammer drills on min. 5 kg with SDS-max chuck



Art. No.	Ø mm	length (mm)	Art. No.	Ø mm	length (mm)
7101	40	290	7108	80	550
7102	40	550	7109	90	290
7103	50	290	7110	90	550
7104	50	550	7111	100	290
7105	68	290	7112	100	550
7106	68	550	7113	125	550
7107	80	290	7114	150	550



Center Drill Bit - Taper Shank 1:20

10 x 120 mm

Art. No. 1143



Drift Keys

Art. No. 7006





SDS + Drill Bits for Wood Working

KISTENMACHER brand SDS Plus Drill Bit Set

packed in PVC box



Art. No.	Ø mm length	pcs / set
3810-5	5x110 - 6x110 - 6x160 - 8x160 - 10x160 mm	5
3810-7	5x110 - 6x110 - 8x110 - 6x160 - 8x160 - 10x160 - 12x160 mm	7

Forstner Bit Basic

Traditional type with center point and two main cutting edges, individually packed in PVC tubes



Art. No.	Ø mm	Art. No.	Ø mm
6500100	10,0	6500280	28,0
6500120	12,0	6500300	30,0
6500140	14,0	6500320	32,0
6500150	15,0	6500340	34,0
6500160	16,0	6500350	35,0
6500180	18,0	6500360	36,0
6500200	20,0	6500380	38,0
6500220	22,0	6500400	40,0
6500240	24,0	6500450	45,0
6500250	25,0	6500500	50,0
6500260	26,0		

Wood Working Drill - Form B

Made of high quality CV steel, CNC precision grinded center point, bicolour finish, optimized flute geometry for quick chip ejection

individually packed in PVC wallet



Art. No.	Ø mm	Art. No.	Ø mm
6000T 030	3.0	6000T 140	14.0
6000T 040	4.0	6000T 150	15.0
6000T 050	5.0	6000T 150	16.0
6000T 060	6.0	6000T 150	18.0
6000T 070	7.0	6000T 150	20.0
6000T 080	8.0	6000T 150	22.0
6000T 090	9.0	6000T 150	24.0
6000T 100	10.0	6000T 150	25.0
6000T 110	11.0	6000T 150	26.0
6000T 120	12.0	6000T 150	28.0
6000T 130	13.0	6000T 150	30.0

Wood Working Drill

Made of high quality CV steel, CNC precision grinded center point, bicolour finish, optimized flute geometry for quick chip ejection

individually packed in PVC wallet



available in 230 mm and 460 mm length

Art. No. 230 mm	Ø mm	Art. No. 460 mm	Ø mm
6250T 060	6.0		
6250T 080	8.0	6400T 080	8.0
6250T 100	10.0	6400T 100	10.0
6250T 120	12.0	6400T 120	12.0
6250T 140	14.0	6400T 140	14.0
6250T 160	16.0	6400T 160	16.0
6250T 180	18.0	6400T 180	18.0
6250T 200	20.0	6400T 200	20.0

Tap Wrenches & Die Stocks

Adjustable Tap Wrenches (No. 130)

zinc die cast - DIN 1814



Art. No.	compatible tap size	Ø mm
130/0	M 1 - 8 - 1/16-1/4"	2.0 - 5.0
130/1	M 1 - 10 - 1/16-3/8"	2.0 - 6.3
130/1.12	M 1 - 12 - 1/16-3/2"	2.1 - 8.0
130/2	M 4 - 12 - 5/32-1/2"	3.0 - 9.0
130/3	M 5 - 20 - 7/32-3/4"	4.9 - 12.0
130/4	M 9 - 27 - 7/16-1"	5.5 - 16.0
130/5	M 13 - 32 - 1/2-1.1/4"	7.0 - 20.0

Adjustable Tap Wrenches (No. 140)

made of steel - DIN 1814

Art. No.	compatible tap size	Ø mm
140/0	M 1 - 8 - 1/16-1/4"	2.0 - 5.0
140/1	M 1 - 10 - 1/16-3/8"	2.0 - 6.3
140/1.12	M 1 - 12 - 1/16-3/2"	2.1 - 8.0
140/2	M 4 - 12 - 5/32-1/2"	3.0 - 9.0
140/3	M 5 - 20 - 7/32-3/4"	4.9 - 12.0
140/4	M 9 - 27 - 7/16-1"	5.5 - 16.0
140/5	M 13 - 32 - 1/2-1.1/4"	7.0 - 20.0
140/6	M 18 - 42 - 3/4 - 1.1/2"	11.0 - 24.0
140/7	M 25 - 52 - 1" - 2"	16.0 - 32.0
140/8	M 25 - 64 - 1" - 2.1/2"	16.0 - 40.0

Tap Wrenches with Ratchet (No. 100)

for right and left hand turn

Art. No.	compatible tap size	length (mm)
100/01	M 03-10 - 1/8-3/8"	85
100/02	M 05-12 - 7/32-1/2"	100
100/10	M 03-10 - 1/8-3/8"	250
100/20	M 05-12 - 7/32-1/2"	300



Die Stocks

zinc die cast



DIN 225/DIN EN 22568 (No. 150)
compatible with size DIN 223

Art. No.	compatible tap size	Ø (mm)
150/2005	M 3-4 - BSW 1/8 - 5/32"	20 x 5
150/2007	M 4.5-6 - BSW 3/16 - 1/4"	20 x 7
150/2509	M 7-9 - BSW 5/16"	25 x 9
150/3011	M 10-11 - BSW 3/8 - 7/16"	30 x 11
150/3814	M 12-14 - BSW 1/2" - 9/16"	38 x 14
150/4518	M 16-20 - BSW 5/8 - 13/16"	45 x 18
150/5522	M 22-24 - BSW 7/8 - 1"	55 x 22

inch (No. 160)

Art. No.	compatible tap size	Ø (inch)
160/0058	15.9 x 6.35 mm - 5/8 x 1/4"	5/8"
160/0001	25.4 x 9.5 mm - 1 x 3/8"	1"
160/0112	38.1 x 12.7 mm - 1.1/2 x 1/2"	1.1/2"
160/0002	50.8 x 15.9 mm - 2 x 5/8"	2"
160/0212	63.5 x 19.0 mm - 2.1/2 - 3/4"	2.1/2"

Hand Tap Wrenches & Round Dies

Hand Taps (No. 4103)

metric - fine ISO - thread DIN 13

all sizes available from M3 to M 110

Hand Tap (No. 4303)

whitworth (BSW) - thread BS84

all sizes available from 1/16" to 2"

Hand Tap (No. 4703)

armoured tube thread DIN 40 430

all sizes available from PG 7 to 48



Center Drill Bits HSS DIN 333 form A 60 degrees

- point angle 120 degrees
- countersinking angle 60 degrees

Art. No.	size (mm)	shank Ø (mm)	L (mm)
1910100	1.00	3.15	31.5
1910125	1.25	3.15	31.5
1910160	1.60	4.00	35.5
1910200	2.00	5.00	40.0
1910250	2.50	6.30	45.0
1910315	3.15	8.00	50.0
1910400	4.00	10.00	56.0
1910500	5.00	12.50	63.0
1910630	6.30	16.00	71.0



Round dies

metric ISO thread DIN 223 (No. 6002)

Art. No.	nominal width	DIN 223 o/d. mm
6002/03	M 3 x 0.5	20 x 05
6002/04	M 4 x 0.7	20 x 05
6002/06	M 6 x 1.0	25 x 07
6002/08	M 8 x 1.25	25 x 09
6002/10	M 10 x 1.5	30 x 11
6002/12	M 12 x 1.75	38 x 14
6002/14	M 14 x 2.0	38 x 14
6002/16	M 16 x 2.0	45 x 18
6002/18	M 18 x 2.5	45 x 18
6002/20	M 20 x 2.5	45 x 18



Round dies

whitworth thread BS 84 (No. 6302)

Art. No.	nominal width	DIN 223 o/d. mm
6302/014	BSW 1/4 x 20	20 x 07
6302/516	BSW 5/16 x 18	25 x 09
6302/038	BSW 3/8 x 16	30 x 11
6302/716	BSW 7/16 x 14	30 x 11
6302/012	BSW 1/2 x 12	38 x 14
6302/058	BSW 5/8 x 11	45 x 18
6302/034	BSW 3/4 x 10	45 x 18

Drill Chuck Arbors (No. 42)

hardened all over and ground
MK = machine capacity
B = chuck capacity

Art. No.	compatible tap size
42/0216	MK2 - B16
42/0316	MK3 - B16
42/0218	MK2 - B18
42/0318	MK3 - B18
42/0333	MK3 - B22



Morse Taper Drill Sleeves DIN 238 (No. 45)

hardened all over and ground
MK = machine capacity

Art. No.	compatible tap size
45/0201	MK 2 x 1
45/0302	MK 3 x 2
45/0402	MK 4 x 2
45/0403	MK 4 x 3
45/0504	MK 5 x 4



Hole Saws

Bi-Metal Hole Saws, 8% HSS-Co

M42 / 4-6 tpi, white



Art. No.	width (mm)	Art. No.	width (mm)	Art. No.	width (mm)	Art. No.	width (mm)	Art. No.	width (mm)
CT 14	14	CT 32	32	CT 52	52	CT 76	76	CT 121	121
CT 16	16	CT 33	33	CT 54	54	CT 79	79	CT 127	127
CT 17	17	CT 35	35	CT 57	57	CT 83	83	CT 133	133
CT 19	19	CT 37	37	CT 58	58	CT 86	86	CT 140	140
CT 20	20	CT 38	38	CT 59	59	CT 89	89	CT 146	146
CT 21	21	CT 40	40	CT 60	60	CT 92	92	CT 152	152
CT 22	22	CT 41	41	CT 63	63	CT 95	95	CT 160	160
CT 23	23	CT 43	43	CT 64	64	CT 98	98	CT 168	168
CT 24	24	CT 44	44	CT 65	65	CT 102	102	CT 177	177
CT 25	25	CT 46	46	CT 67	67	CT 105	105	CT 200	200
CT 27	27	CT 48	48	CT 68	68	CT 108	108	CT 210	210
CT 29	29	CT 50	50	CT 70	70	CT 111	111		
CT 30	30	CT 51	51	CT 73	73	CT 114	114		

Arbors for Hole Saws, hex shank

Art. No.	Sizes
A1/8,5	14 - 30 mm A1/8,5
A2/11	14 - 30 mm A2/11
A3/8,5	32 - 210 mm A3/8,5
A4/11	32 - 210 mm A4/11

Arbors for Hole Saws

Art. No.	Sizes
A5/11	32 - 210 mm A5/11
A10/6,35	14 - 30 mm A10/6,35
A7SDS	14 - 30 mm A7 SDS
A8SDS	32 - 210 mm A8 SDS

A1/8,5

A2/11

A3/8,5

A4/11

A5/11

A7SDS

A8SDS

Replacement Drills

Art. No.	dia Ø (mm)	length (mm)	suitable for
B1	6,35	83	A1, A2, A3, A4, A5, A7, A8
B2	6,35	105	A10, multicut holesaw with A1, A2, A3, A4, A5, A7, A8



Files

KISTENMACHER brand Engineer File Sets

second cut No. 2, in PVC wallet, with soft PVC 2-component handle - black/blue, 5 pcs/set, **for metal working**

Art. No.	Sizes
A918002-M2KT150	file length 150 mm
A918002-M2KT200	file length 200 mm
A918002-M2KT250	file length 250 mm

- consisting of:
- flat
 - half round
 - three square
 - square
 - round



KISTENMACHER brand Rasp Sets

second cut No. 2, in PVC wallet, with soft PVC 2-component handle - black/blue, 5 pcs/set, **for wood working**

Art. No.	Sizes
A918002-W2KT150	file length 150 mm
A918002-W2KT200	file length 200 mm
A918002-W2KT250	file length 250 mm

- consisting of:
- flat
 - half round
 - three square
 - square
 - round



Needle File Sets

in PVC wallet, 6 pcs set

Art. No.	Sizes
983142001	file length 140 mm
983162001	file length 160 mm
983182001	file length 180 mm

- consisting of:
- flat hand
 - flat hand 2 flat edges
 - half round
 - round
 - square
 - three square



other sets and versions available upon request

Files

Engineers' Files - flat hand

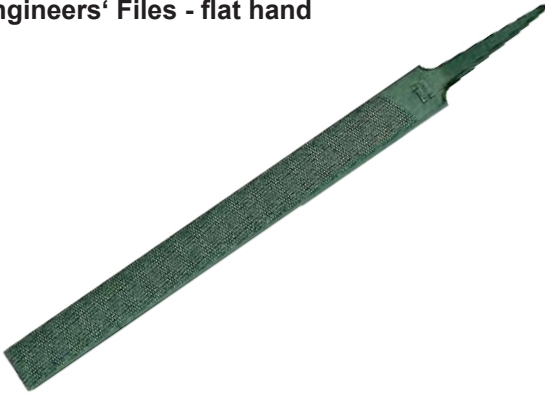

Art. No. bastard type	Art. No. second type	Art. No. smooth cut	size (mm - inch)	Ø mm
900100101	900100201	900100301	100 - 4"	12 x 3
---	900120201	---	125 - 5"	13 x 3
900150101	900150201	900150301	150 - 6"	15 x 4
900200101	900200201	900200301	200 - 8"	20 x 5
900250101	900250201	900250301	250 - 10"	25 x 6
900300101	900300201	---	300 - 12"	30 x 7
900350101	900350201	---	350 - 14"	35 x 8

Engineers' Files - flat file - 2 flat edges

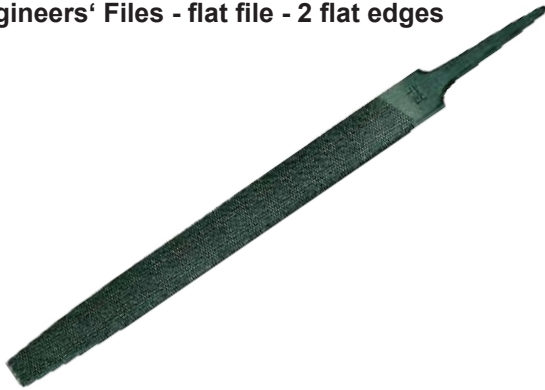

Art. No. bastard type	Art. No. second type	Art. No. smooth cut	size (mm - inch)	Ø mm
---	906100201	---	100 - 4"	12 x 3
906120101	906120201	---	125 - 5"	13 x 3
906150101	906150201	---	150 - 6"	15 x 4
906200101	906200201	---	200 - 8"	20 x 5
906250101	906250201	---	250 - 10"	25 x 6
906300101	---	---	300 - 12"	30 x 7

Engineers' Files - three square



Art. No. bastard type	Art. No. second type	Art. No. smooth cut	size (mm - inch)	Ø mm
912100101	912100201	912100301	100 - 4"	8
---	912120201	---	125 - 5"	10
912150101	912150201	912150301	150 - 6"	11
912200101	912200201	912200301	200 - 8"	15
912250101	912250201	912250301	250 - 10"	19
912300101	912300201	912300301	300 - 12"	21
912350101	---	---	350 - 14"	24

Engineers' Files - square

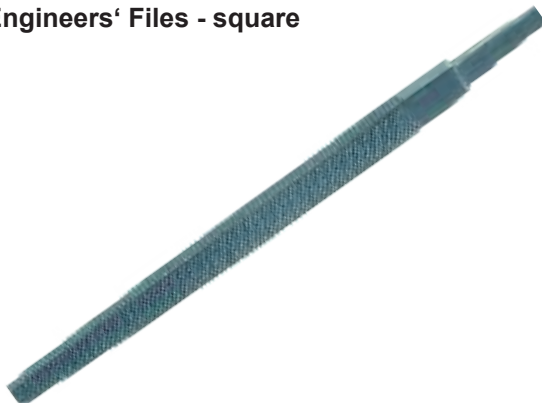

Art. No. bastard type	Art. No. second type	Art. No. smooth cut	size (mm - inch)	Ø mm
913100101	913100201	913100301	100 - 4"	5
913120101	913120201	---	125 - 5"	5
913150101	913150201	913150301	150 - 6"	6
913200101	913200201	913200301	200 - 8"	8
913250101	913250201	913250301	250 - 10"	10
913300101	913300201	913300301	300 - 12"	12

Files

Engineers' Files - half round

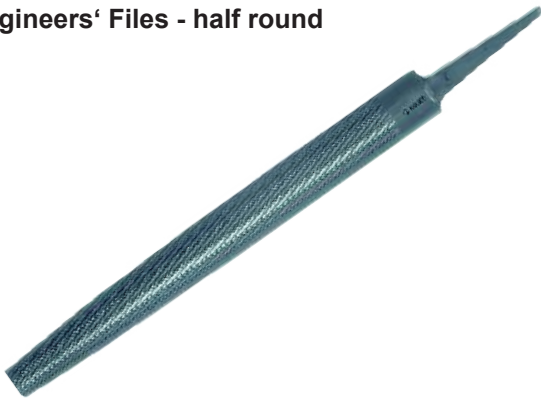

Art. No. bastard type	Art. No. second type	Art. No. smooth cut	Size (mm - inch)	Ø mm
910100101	910100201	910100301	100 - 4"	11 x 3.5
910120101	910120201	---	125 - 5"	14 x 4
910150101	910150201	910150301	150 - 6"	16 x 4.5
910200101	910200201	910200301	200 - 8"	21 x 6
910250101	910250201	910250301	250 - 10"	25 x 7
910300101	910300201	---	300 - 12"	30 x 8.5
910350101	910350201	---	350 - 14"	35 x 10

Engineers' Files - round

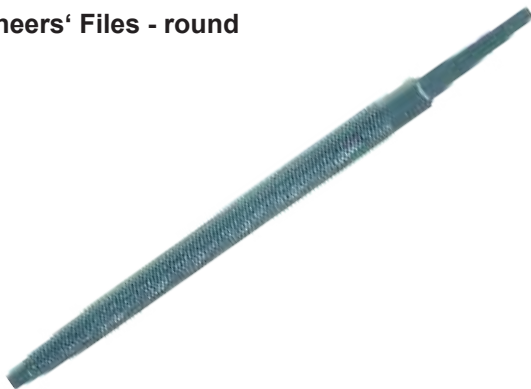

Art. No. bastard type	Art. No. second type	Art. No. smooth cut	Size (mm - inch)	Ø mm
914100101	914100201	914100301	100 - 4"	8
914120101	914120201	---	125 - 5"	10
914150101	914150201	914150301	150 - 6"	11
914200101	914200201	914200301	200 - 8"	15
914250101	914250201	914250301	250 - 10"	19
914300101	914300201	---	300 - 12"	21

Car Body File Holders

with adjustable aluminium handle
embossed with „Made in Germany“
length: 355 mm

Art. No. 2160002



Car Body File Blades

curved tooth
length: 350 mm, cross section 36 x 5.5 mm

Art. No.	Description
G052301350	coarse cut
G052302350	medium cut
G052303350	fine cut



Pliers

KISTENMACHER brand End Cutting Nippers

for steel wire, extra wide cutting edge, with polished head and red PVC coated handles



Art. No.	length (mm)
39-1610/2622-KI	160
39-1810/2622-KI	180
39-2010/2622-KI	200

End-Cutting Nippers

for soft and hard wire, extra wide cutting edge, black lacquered with polished head and red PVC coated handles



Art. No.	length (mm)
39-1610/2622	160
39-1810/2622	180
39-2010/2622	200

Tower Pincers, for fast and economic twisting and cutting of tie wire

black lacquered, polished head



Art. No.	length (mm)	handle design
93-1910/2622	190	PVC coated handles
93-2210/2622	220	PVC coated handles
93-2510/2622	250	PVC coated handles
93-2810/2622	280	PVC coated handles
93-3010/2622	300	PVC coated handles
93-1910/2600	190	without handle coating
93-2210/2600	220	without handle coating
93-2510/2600	250	without handle coating
93-2810/2600	280	without handle coating
93-3010/2600	300	without handle coating

Waterpump Pliers, box joint design



Art. No.	length (mm)	handle design
77-1750/2022	170	polished PVC handle
77-2550/2022	250	polished PVC handle
77-3050/2022	300	polished PVC handle

Waterpump Pliers with laid-on slip-joint



Art. No.	length (mm)	handle design
79-1700/5022	175	polished PVC handle
79-2500/5022	240	polished PVC handle

Pliers

Combination Pliers

with facet and cutter (involute pipe hole) and polished head



Art. No.	length (mm)	handle design
41-1600/20RR	160	ergonomic 2-component handles
41-1800/20RR	180	ergonomic 2-component handles
41-2000/20RR	200	ergonomic 2-component handles
41-1600/2022	160	PVC coated handles
41-1800/2022	180	PVC coated handles
41-2000/2022	200	PVC coated handles

Side Cutters

polished head



Art. No.	length (mm)	handle design
25-1400/20RR	140	ergonomic 2-component handles
25-1600/20RR	160	ergonomic 2-component handles
25-1800/20RR	180	ergonomic 2-component handles
25-1400/2022	140	PVC coated handles
25-1600/2022	160	PVC coated handles
25-1800/2022	180	PVC coated handles

Telephone Pliers with cutter

polished head - straight



Art. No.	length (mm)	handle design
15-1400/20RR	140	ergonomic 2-component handles
15-1600/20RR	160	ergonomic 2-component handles
15-2000/20RR	200	ergonomic 2-component handles
15-1400/2022	140	PVC coated handles
15-1600/2022	160	PVC coated handles
15-2000/2022	200	PVC coated handles

Telephone Pliers with cutter

polished head - bent 45°



Art. No.	length (mm)	handle design
17-1600/20RR	160	ergonomic 2-component handles
17-2000/20RR	200	ergonomic 2-component handles
17-1600/2022	160	PVC coated handles
17-2000/2022	200	PVC coated handles

Pliers - VDE

Combination Pliers VDE - 1000V

with facet and cutter (involute pipe hole)
and polished head and two-component handle



Art. No.	length (mm)	handle design
41-1600/40RV	160	ergonomic 2-component handles
41-1800/40RV	180	ergonomic 2-component handles
41-2000/40RV	200	ergonomic 2-component handles

Side Cutters VDE - 1000V

polished head and two-component handle



Art. No.	length (mm)	handle design
25-1400/40RV	140	ergonomic 2-component handles
25-1600/40RV	160	ergonomic 2-component handles
25-1800/40RV	180	ergonomic 2-component handles

Telephone Pliers with cutter VDE - 1000V

polished head - straight



Art. No.	length (mm)	handle design
15-1400/40RV	145	ergonomic 2-component handles
15-1600/40RV	160	ergonomic 2-component handles
15-2000/40RV	200	ergonomic 2-component handles

Wire stripping Pliers with spring and adjusting screw VDE - 1000V

polished head



Art. No.	length (mm)	handle design
48-1600/40RV	160	ergonomic 2-component handles

Circlip Pliers

Circlip Pliers for External Circlips
polished head - straight jaws



Art. No.	length (mm)	type	handle design
54-0300/2622	135	A0	PVC coated handle
54-1000/2622	135	A1	PVC coated handle
54-1900/2622	180	A2	PVC coated handle
54-4000/2622	225	A3	PVC coated handle
54-8500/2622	320	A4	PVC coated handle

Circlip Pliers for External Circlips
polished head - bent jaws 90°



Art. No.	length (mm)	type	handle design
55-0300/2622	135	A01	PVC coated handles
55-1000/2622	135	A11	PVC coated handles
55-1900/2622	180	A21	PVC coated handles
55-4000/2622	225	A31	PVC coated handles
55-8500/2622	320	A41	PVC coated handles

Circlip Pliers for Inside Circlips
polished head - straight jaws



Art. No.	length (mm)	type	handle design
56-0800/2622	135	J0	PVC coated handles
56-1200/2622	135	J1	PVC coated handles
56-1900/2622	180	J2	PVC coated handles
56-4000/2622	225	J3	PVC coated handles
56-8500/2622	320	J4	PVC coated handles

Circlip Pliers for Inside Circlips
polished head - bent jaws 90°



Art. No.	length (mm)	type	handle design
57-0800/2622	135	J01	dip coated handles
57-1200/2622	135	J11	dip coated handles
57-1900/2622	180	J21	dip coated handles
57-4000/2622	225	J31	dip coated handles
57-8500/2622	320	J41	dip coated handles

Bolt Cutter and Pipe Grip Wrenches

Bolt Cutters, HRC 40/44+

- exchangeable cutter head
- powerful transmitting toggle joint
- impact resistance powder coated steel tube handles



Art. No.	length (mm)	length (inch)	HRC
97-1330/5RZO	330	13"	40
97-1400/5RZO	400	16"	40
97-1460/5RZO	460	18"	44
97-1620/5RZO	620	24"	44
97-1780/5RZO	780	30"	44
97-1900/5RZO	900	35"	44



Universal key Profi-Key

made from zinc die casting with chain, adapter and bit for sanitary installation, heating, ventilation and air-condition systems as well as building construction applications

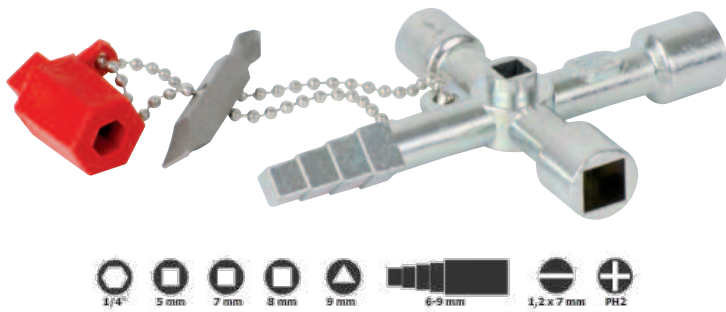

Art. No.	length (mm)
48-7100/3402	90 x 62

„EvoShark“ Cable shears

fine cutting edge for clean and smooth cutting of copper and aluminium cables, one hand operation with integrated spring and catch, not for hard drawn copper conductors or steel wire



Art. No.	length (mm)	handle design
47-1800/40RV VDE	180	ergonomic 2-component handles
47-1800/40RV VDE	220	ergonomic 2-component handles
47-1800/30RR	180	PVC coated handles
47-2200/30RR	220	PVC coated handles

Adjustable Pipe Grip Wrenches with Nut

straight version



Art. No.	length (mm)	length (inch)	weight (g)
136/7	178	7	300
136/9	228	9	531
136/10.5	281	11	851
136/12	315	12	1038
136/14	360	14	1656



Adjustable Pipe Grip Wrenches with Nut

straight version



Art. No.	length (mm)	weight (g)
257/175	175	300
257/240	240	500
257/270	270	700
257/300	300	900



Hydraulic Crimping and Cutting Tools

Hydraulic Crimping Tool Set with Foot Pump in blue metal case

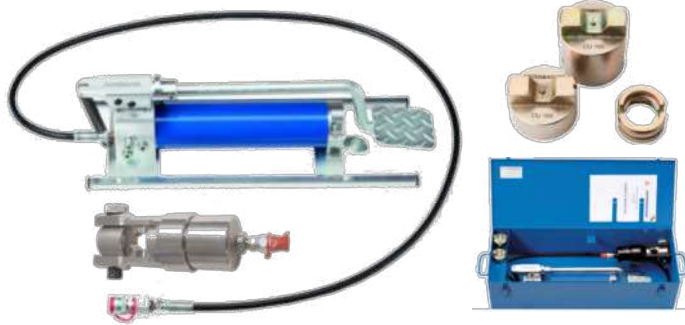

foot-operated double piston pump, 700 bar, with automatic change-over and pressure relief valve and coupling, complete with 2 mtr. mounted high pressure hose, with rotating nickel plated crimping head - in blue metal transport case

with yellow chromatised CU-hexagonal crimping dies, sets consisting of the following dies:

SET PK 250 (14 pieces)
16, 25, 35, 50, 70, 95, 120, 150, 185, 240, 300, 400, 500, 630 mm²

SET PK 250 KI-S9 (9 pieces)
95, 120, 150, 185, 240, 300, 400, 500, 630 mm²

Art. No.	crimping force	crimping range
SET PK 250 KI	250 kN	16 - 630 mm ²
SET PK 250 KI-S9	250 kN	95 - 630 mm ²

Hydraulic Crimping Tool Set with Foot Pump in blue metal case

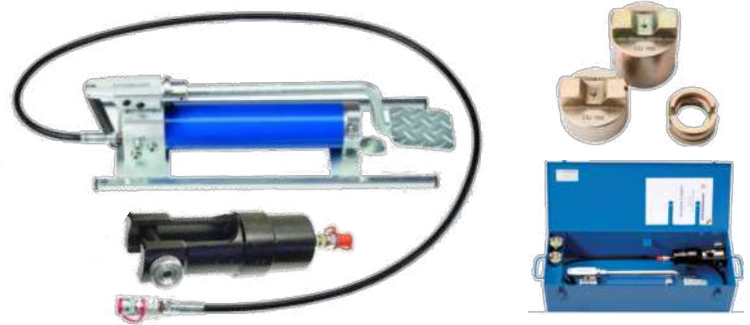

foot-operated double piston pump, 700 bar, with automatic change-over and pressure relief valve and coupling, complete with 2 mtr. mounted high pressure hose, with rotating nickel plated crimping head - in blue metal transport case

with yellow chromatised CU-hexagonal crimping dies, sets consisting of the following dies:

SET PK 450 (11 pieces)
95, 120, 150, 185, 240, 300, 400, 500, 630, 800, 1.000 mm²

Art. No.	crimping force	crimping range
SET PK 450 KI	450 kN	95 - 1000 mm ²

Hydraulic Cable Cutting Tool Set with Foot Pump in blue metal case

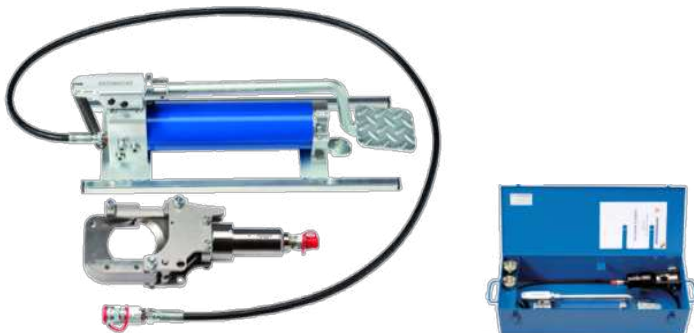

foot-operated double piston pump, 700 bar, with automatic change-over and pressure relief valve and coupling, complete with 2 mtr. mounted high pressure hose, with rotating cutting head - in blue metal transport case

suitable for aluminium and copper cable

Art. No.	crimping force	crimping range
SET SK 85 KI	70 kN	85 mm
SET SK 120 KI	100 kN	120 mm

Hydraulic Foot Pump



foot-operated double piston pump with automatic change-over and pressure relief valve, complete with 2 mtr. mounted, high pressure hose and coupling - without metal case

Art. No.	pressure	hose length
FP 700	700 bar	2 meters

Hydraulic Crimping and Cutting Tools



Hydraulic Cable Cutter Head

chrome-plated rotating cutting head with double piston pump and automatic safety relief valve
suitable for power copper and aluminium cables



Art. No.	cutting force	cutting range
SK 85 KI	70 kN	85 mm

Hydraulic Cable Cutter Head

black laquered rotating cutting head with double piston pump and automatic safety relief valve



Art. No.	cutting force	cutting range	suitable cables
SET SK 120 KI	100 kN	120 mm	CU + AL
SET SK 120 ST-KI	100 kN	120 mm	Armoured Copper

Hydraulic Cable Cutter Head

black laquered rotating cutting head with double piston pump and automatic safety relief valve
suitable for **armoured copper**, aluminium, ACSR cables and solid steel bars up to 16 mm



Art. No.	cutting force	cutting range
SK 45 KI	70 kN	45 mm

Hydraulic Cable Cutter Head - Shear Type - open

with quick coupling suitable for foot pump / electro pump up to 700 bar, suitable for power copper and aluminium cables



Art. No.	cutting force	cutting range
SK 120 O	100 kN	120 mm

Hydraulic Crimping and Cutting Tool Sets



Hydraulic Crimping Tool Set

hand-operated, with rotating C-compression head, double piston pump and automatic safety relief valve, in blue metal carrying case

complete with yellow chromatinized CU-hexagonal crimping dies (13 pcs)



Hydraulic Crimping Tool Set

hand-operated, with rotating C-compression head, double piston pump and automatic safety relief valve, in blue metal carrying case

complete with yellow chromatinized CU-hexagonal crimping dies (13 pcs)

with extra large opening of 42mm head, suitable as well for C- and H-clamps



Art. No.	weight (g)	length (mm)	crimping force	crimping range
SET PK 130 KI	7.800	695	130 kN	10 - 400 mm ²

Art. No.	weight (g)	length (mm)	crimping force	crimping range
SET PK 130 KI / 42	8.200	705	130 kN	10 - 400 mm ²

Hydraulic Crimping Tool Set

hand-operated, with rotating round-compression head, double piston pump and automatic safety relief valve, in blue metal carrying case

complete with yellow chromatinized CU-hexagonal crimping dies (12 pcs)



Hydraulic Cable Cutter

hand-operated, with rotating cutting head, double piston pump and automatic safety relief valve, in blue metal carrying case

suitable for copper and aluminium cables



Art. No.	weight (g)	length (mm)	crimping force	crimping range
SET HP60/22 KI	3.500	450	60 kN	10 - 300 mm ²

Art. No.	weight (g)	length (mm)	cutting force	cutting range	suitable cables
HS 45 KI	7.500	680	60 kN	max. 45 mm	Armoured copper
HS 50 KI	6.500	680	60 kN	max. 50 mm	CU + AL
HS 85 KI	12.000	700	70 kN	max. 85 mm	CU + AL

Battery Operated Hydraulic Tools

Hydraulic Crimping Tool Set



battery powered with memory card, packed in blue metal carrying case

- rotating crimping head
- yellow chromatised, CU-hexagonal crimping dies
- spare battery, battery charger, software and USB data cable

- with open head



Art. No.	crimping force	crimping range	number of dies
APE 6-22 KI	60 kN	10 - 300 mm ²	12

Hydraulic Crimping Tool Set



- with C-head (29 mm)

Art. No.	crimping force	crimping range	number of dies
APE 13C KI	130 kN	10 - 400 mm ²	13

Hydraulic Crimping Tool Set



- rotating crimping head
- yellow chromatised, CU-hexagonal crimping dies
- spare battery, battery charger software and USB data cable

- with open head

Both battery powered with memory card, packed in blue metal carrying case



Art. No.	crimping force	crimping range	number of dies
APEM 5-5	50 kN	- 10-150 mm ² (Aluminium)	9
		- 10-185 mm ² (Copper)	10
		- 10-240 mm ² (Standard)	11

Hydraulic Cutting Tool Set



Art. No.	cutting force	cutting range
ASE 85 KI	70 kN	max. 85 mm

Electrohydraulic Pump for use with mains 220 - 240V



With digital pressure gauge, equipped with 2 mtr. hydraulic hose and quick couplings, suitable to connect most common crimping and cutting devices.

Longer hydraulic hoses and bigger tank volume available on request

- max. pressure (HD) 700 bar
- min. pressure (ND) 60 bar
- haul capacity (HD) 0,34 l / min
- haul capacity (ND) 0,80 l / min
- motor capacity 0,37 kw
- engine rpm 1360
- tank volume 2,0 ltr
- weight 18,0 kgs
- voltage 220-240 V / 50/60 Hz
- noise level 75 dBA

Art. No.	operating pressure	motor capacity
AKPE2 KI	700 bar	0,37 kw

Battery Operated Hydraulic Drive Unit

Equipped with 1,50 mtr. hydraulic high pressure hose and quick couplings, suitable to connect most common crimping and cutting devices, total weight 4,90 kgs only

Including:

- remote control and strap
- bag
- read-out option of the machine status
- failure analysis
- li-ion battery 3.000 mA / 18V



Art. No.	operating pressure
AKPE1 KI	700 bar

Mechanical Crimping Tools

Made in Slovakia



Syncro Crimping Tools with two-component handle, Hexagonal Crimping

Mechanical Crimping Tools with revolving dies Indent Crimping



mechanical crimping tool for tubular cable lugs and connectors, standard type, synchronised die selection when in the open position, cross-section display on marked adjusting wheel, extremely lightweight and rigid

mechanical crimping tool for tubular cable lugs and connectors, standard type, with revolving dies, PVC coated handles, with blue/yellow insulation

Art. No.	crimping range	length
K 05	6 - 50 mm ²	380mm
K 06	10 - 120 mm ²	650-750 mm - telescopic handle
K 09	25 - 150 mm ²	650-750 mm - telescopic handle

Art. No.	crimping range	length
K 5	6 - 50 mm ²	600 mm

Crimping Hand Tool

suitable for red/blue/yellow insulated DIN cable lugs, pin cable lugs, tabs and receptacles, circular connectors and receptacles butt and parallel connectors

Crimping Hand Tool

with exchangeable crimping die sets



Art. No.	cross ref.	red	blue	yellow
CK 90-44	CK 90	0,5-1,0 mm ²	1,5-2,5 mm ²	4,0-6,0 mm ²

Art. No.	cross ref.	range (mm ²)	application
CK 100 SET 44	CK 100-44	0,5-6,0	red/blue/yellow cable lugs/ pin cable lugs, tabs, receptacles, circular connectors, butt parallel connectors
CK 100 SET 65	CK 100-65	0,5-10,0	flat push-on receptacles and tabs without insulation
CK 100 SET AE21	CK 100-AE21	0,14-10,0	wire end ferrules with and without insulation sleeve

Mechanical Cable Cutters

Made in Slovakia



Mechanical Cable Cutter for CU und AL Cables

PVC coated handles, suitable for CU and AL cables

not suitable for cutting steel or steel wire



Art. No.
Cutting Range
Length
Colour

K 100	K 101/1	K 101/2	K 130	K 150
max. Ø 14 mm	max. Ø 26 mm	max. Ø 38 mm	max. Ø 30 mm	max. Ø 50 mm
280 mm	570 mm	930 mm	570 mm	710 mm
blue/yellow	blue/yellow	blue/yellow	blue/yellow	blue/yellow

Mechanical Cable Cutter for CU und AL Cables

PVC coated handles, suitable for CU and AL cables

not suitable for cutting steel or steel wire



Art. No.
Cross ref.
Cutting Range
Length
Colour

SH 340	SH 620	SH 1000	SHF 340
K 106/1	K 106/2	K 104/1	N/A
max. Ø 34 mm	max. Ø 62 mm	max. Ø 100 mm	max. Ø 34 mm
261 mm	297 mm	870 mm	298 mm
blue	blue	blue/yellow	blue

Knockout Punching Tool

ALFRA - Tricut® Knockout Punching tool with 3-fold split

complete with ball bearing screw
ball bearings encapsulated in orange aluminium rings,
individually packed in plastic box

Art. No.	weight (g)
01692	1/2"
01698	3/4"
01711	1"
01718	1 1/4"
01723	1 1/2"
01732	2"



Other sizes available upon request

ALFRA - Hole Puncher Monocut®

complete with ball bearing screw
ball bearings encapsulated in orange aluminium rings,
individually packed in plastic box

Art. No.	weight (g)
01046	1/2"
01070	3/4"
01118	1"
01162	1 1/4"
01170	1 1/2"
01206	2"



Other sizes available upon request

ALFRA - Tricut® Knockout Punching tool sets

complete with ball bearing screw
ball bearings encapsulated in orange aluminium rings,
all sets are supplied in heavy-duty practical plastic cases

Art. No.	pcs per set	inch/ mm	sizes
01757	7	mm	M16 - M20 - M25 - M32 - M40 - M50 - M60
01760	6	inch	1/2" - 3/4" - 1" - 1 1/4" - 1 1/2" - 2"
01761	6	inch	1/2" - 3/4" - 1" - 1 1/4" - 1 1/2" - M 50
01762	5	mm	M16 - M20 - M25 - M32 - M40



ALFRA - Hole Puncher Monocut® sets

complete with ball bearing screw
ball bearings encapsulated in orange aluminium rings,
all sets are supplied in heavy-duty practical plastic cases

Art. No.	pcs per set	inch/ mm	sizes
01291	7	mm	M16 - M20 - M25 - M32 - M40 - M50 - M60
01459	6	inch	1/2" - 3/4" - 1" - 1 1/4" - 1 1/2" - 2"
01463	6	inch	1/2" - 3/4" - 1" - 1 1/4" - 1 1/2" - M 50
01290	5	mm	M16 - M20 - M25 - M32 - M40



Hydraulic Punch Drivers

Hydraulic Punch Driver Set

- extremely versatile and easy-to-use hole punching tool thanks to 360° rotatable punching head
- lightweight aluminium construction for easy operation and effortless portability
- punching range : Ø 22,5 - 61,5 mm / 3,5 mm mild steel



Accessories: **Punches (type D): 22,5 - 28,3 - 34,6 - 43,6 - 49,6 - 61,5 mm**
 7/16" x 3/4" draw stud
 3/4" x 3/4" draw stud
 Spacer
 Sealing kit



Art. No.	punching force	stroke	weight
EGK WK-8AL	70 kN	25 mm	abt. 2,10 kg
EGK WK-12AL	120 kN	27 mm	abt. 3,0 kg

Manual Knock Out Punch Set



EGK MPS 1/2-1.14



EGK MPS 1.1/2-2

Art. No.	size	contents / descriptions	hole size (actual) Ø inch	hole size (actual) Ø mm
EGK MPS 1/2-1.14	1/2" - 1 1/4"	1/2" Conduit size punch and die	7/8"	22,50
		3/4" Conduit size punch and die	1,115"	28,30
		1" Conduit size punch and die	1,362"	34,60
		1"-1/4" Conduit size punch and die	1,701"	43,20
		3/8" , 24UN Draw stud with bearing 3/4" , 16UN Draw stud with bearing		
EGK MPS 1.1/2-2	1/2" - 2"	1-1/2" Conduit size punch and die	1-15/16"	49,60
		2" Conduit size punch and die	2-3/8"	61,50

Snips

American Pattern Snips

for straight cuts - only left cutting available with blue PVC coated handles

Art. No.	length (mm)	length (Inch)	weight (g)	PU
218006-175	175	7	210	6
218006-200	200	8	240	6
218006-250	250	10	440	6
218006-300	300	12	660	6
218006-350	350	14	800	6



English Pattern Snips - Gilbow

with lacquered handles

Art. No.	length (mm)	length (Inch)	weight (g)	PU
216960-200	200	8	200	6
216960-250	250	10	400	6
216960-300	300	12	600	6
216960-350	350	14	850	6



Snip English Pattern

with lacquered handles and long spring and plastic strap

Art. No.	length (mm)	length (Inch)	weight (g)	PU
216900-200	200	8	270	6
216900-250	250	10	380	6
216900-300	300	12	560	6



Figure Snips

with 2-component handle, light model **left** cutting

Art. No.	length (mm)	length (Inch)
212700-250	250	10



Figure Snips

with 2-component handle, light model **right** cutting

Art. No.	length (mm)	length (Inch)
212750-250	250	10



Figure Snips

with 2-component handle, light model **straight** cutting

Art. No.	length (mm)	length (Inch)
212800-250	250	10



Pipe Cutting & Bending



KISTENMACHER brand Tube Cutter for Copper Tubes

precision machining provides quickest and smoothest action, extremely robust and compact - easy to use

Art. No.	size	description
63170	32 mm	for copper tubes
63119	42 mm	for copper tubes

63119

63170

Pipe Cutter for Steel Tubes

with one cutting wheel and two guide rollers

Art. No.	pipe Ø	weight (kg)	description
63172	1/8" - 2"	2,5	for steel pipes
63175	2" - 4"	8	for steel pipes
63101	spare wheel		for steel pipes 63172
63185	spare wheel		for steel pipes 63175

63172

63175

63101

Hydraulic Pipe Bending Tools

the innovative 2-velo valve system enables automatically fast pre-loading together with a soft bending without any need to change pistons

Art. No.	pipe Ø	description
60015	1/4" - 2"	up to 10 tons
60016	1/4" - 3"	up to 13 tons



VIRAX brand Plastic Tube Cutter up to 42 mm

- cuts: PVC, PE, PER, PEX, flexible plastic pipes, sprinkler hoses, irrigation hoses, multilayer
- locking catch: keeps the lower handle closed, easy storage.
- no risk of injury
- ergonomics: the lower handle's special shape is suitable for all hand sizes.
- soft Touch® handle: non-slip grip for firm control



Art. No.	cutting Ø (mm)	length (mm)	height (mm)	weight (g)
214026	28			170
215032	32	198	90	195
215042	42	238	113	530

214026

215032

215042

Hedge shears

Hedges shears forged steel, hollow ground therefore self-sharpening, shock absorber buffer and branch cutter, forged-in nut security.

Hedge shear 1908: hard chromed blades red handles, metal ferrules, long lasting hand protecting buffers, pruning notch, forged-in nut security

Art. No.	blade length	overall length	range Ø	packing unit
1010731	16 cm	40 cm	10 mm	4



Hedge shear 1910: hard chromed blades red handles, metal ferrules, long lasting hand protecting buffers, pruning notch, forged-in nut security

Art. No.	blade length	overall length	range Ø	packing unit
1010729	20 cm	48 cm	12 mm	4



Hedge shear 1912: hard chromed blades red handles, metal ferrules, long lasting hand protecting buffers, pruning notch, forged-in nut security

Art. No.	blade length	overall length	range Ø	packing unit
1010742	23,5 cm	56 cm	14 mm	4



Hedge shear 1914: hard chromed blades red handles, metal ferrules, long lasting hand protecting buffers, pruning notch, forged-in nut security

Art. No.	blade length	overall length	range Ø	packing unit
1010758	28 cm	64 cm	16 mm	4



Hedge shear 1954: Traditional shears

Wavy hedge shear, hard chromed blades pruning notch, long lasting buffers, red handles, forged-in nut security

Art. No.	blade length	overall length	range Ø	packing unit
1010577	24 cm	55 cm	16 mm	4



Bypass pruning shears - ALUMINIUM FORGED

Pruning shear 2002

aluminium forged, replaceable blade and hook made of high quality carbon steel, wire cutter, serrated bolt, buffer with toolholder



Art. No.	cutting diameter	overall length	packing unit
1030718	22 cm	21 cm	6

Pruning shear 2006

aluminium forged, perfect for smaller hands, with ergonomic handle, high quality carbon steel blade bypass action, groove for cutting wire buffer with toolholder



Art. No.	cutting diameter	overall length	packing unit
1030725	22 cm	21 cm	6

Pruning shear 2008

aluminium forged, with ergonomic handle for the protection of your wrist, blade and hook made of high quality carbon steel, wire cutter, serrated bolt, buffer with toolholder



Art. No.	cutting diameter	overall length	packing unit
1030720	22 cm	21 cm	6

Pruning shear 2007

aluminium forged, with ergonomic handle for the protection of your wrist, blade and hook made of high quality carbon steel, wire cutter, serrated bolt, buffer with toolholder



Art. No.	cutting diameter	overall length	packing unit
1030719	22 cm	21 cm	6

Garden Shears

Classic Lopping Shears - bypass system

cutting head with anti-adhesive blades for clean cut, chrome plated, all screw joints are fixed with self locking nut, high-grade aluminium tubes and handles with hand guard



Art. No.	length (mm)	weight (g)
4195	460	740
4200	600	900
4204	760	1030

Pruning Hand Shears

replaceable blade and counter-blade, forged aluminium handles, shock absorber, deep sap groove, wire cutting notch, straight cutting head, intermediate cutting position, ergonomically-designed handles



Art. No.	length (mm)	weight (g)
1100	190	215
1110	220	240

Pruning Hand Shears

forged metal body, chromium plated counter-blade with deep sap groove, replaceable blade, wire cutting notch, ergonomically-designed handle



Art. No.	length (mm)	weight (g)
1200	280	280

Gardening Shears

forged metal body - chromium plated cutting head



Art. No.	length (mm)	weight (g)
1760	220	245

Sheep Shears

round spring, straight hot drop forged model

Art. No.	length (mm)	cutting length (mm)	weight (g)
2711	310	140	250
2712	330	155	285
2713	350	160	360



BERGER

made to cut. SINCE 1919

Axes & Hatchets



Hatchets (German Type)

in accordance to German DIN standards, safety proofed, with ash wooden handle, red-dipped grip



Art. No.	weight (g)	handle length (mm)
11306	600	360
11307	700	360
11308	800	380
11310	1000	400



Axes (German Type)

in accordance to German DIN standards, safety proofed, with ash wooden handle, red-dipped grip



Art. No.	weight (g)	handle length (mm)
10110	1000	600
10112	1250	700
10114	1400	700
10116	1600	800
10117	1750	900
10120	2000	900
10122	2250	900



Hatchets (American Type)

yankee version with ash wooden handle, red-dipped grip



Art. No.	weight (g)	weight (lb)	handle length (mm)
11426	600	1 1/4	380
11427	700	1 1/2	380
11428	800	1 3/4	380
11429	900	2	380



Hooked Crafting Pocket Knife

handle made of wood, blade of stainless steel available in blister packing or PVC bag



Art. No.	weight (g)	blade length (mm)	handle length (mm)	length (mm)
C330	120	80	115	195



Hammers

Rivetting Hammers DIN 1041

german pattern, ash wood handle



Art. No.	weight (g)
0000101-0050	50
0000101-0100	100
0000101-0150	150
0000101-0200	200
0000101-0250	250
0000101-0300	300
0000101-0350	350
0000101-0400	400

Art. No.	weight (g)
0000101-0500	500
0000101-0600	600
0000101-0800	800
0000101-1000	1,000
0000101-1250	1,250
0000101-1500	1,500
0000101-2000	2,000

Copper Hammers

sledge hammer shape, ash wood handle



Art. No.	weight (g)
0033001-0250	250
0033001-0500	500
0033001-0750	750
0033001-1000	1,000
0033001-1500	1,500
0033001-2000	2,000

Sledge Hammers DIN 1042

with cross peen, straight hickory handle



Art. No.	weight (g)	handle length (mm)
0000202-03	3,000	600
0000202-04	4,000	700
0000202-05	5,000	800
0000202-06	6,000	800
0000202-08	8,000	900

Mining Sledges DIN 6476

double faced, ash wood handle



Art. No.	weight (g)	handle length (mm)
0000401-1000	1,000	260
0000401-1250	1,250	270
0000401-1500	1,500	280
0000401-2000	2,000	300
0000402-03	3,000	600
0000401-04	4,000	700
0000402-05	5,000	800
0000402-06	6,000	900
0000402-08	8,000	900

Hammers

PICARD



Enineers Hammers

with cross peen, english pattern, ash wood handle



Art. No.	weight (lbs)
0001001-0100	1/4
0001001-0225	1/2
0001001-0340	3/4
0001001-0450	1
0001001-0500	1 1/8
0001001-0600	1 1/4
0001001-0700	1 1/2
0001001-0800	1 3/4
0001001-0900	2

KISTENMACHER brand RIP Claw Hammers

curved type, straight for easy demolition, with tubular shaft, with 2K grip



Art. No.	weight (oz)	length (mm)
054900000	16	330

Claw Hammers

american pattern, polished finish, with tubular steel and special grip



Art. No.	weight (oz)
0029100-13	13
0029100-16	16

Carpenters' Roofing Hammers DIN 7239

black, with tubular steel shaft and black grip (rough surface)

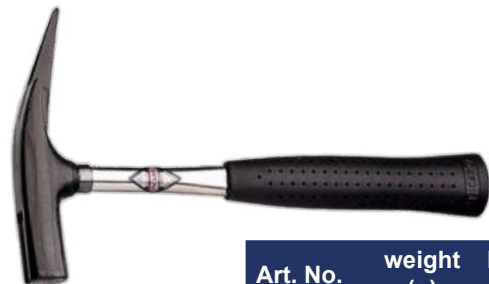

Art. No.	weight (g)	length (mm)
0060010	600	320

Wooden Mallets

head white beech wood material without metal coat, handle and wedge glued, ash wood handle



Art. No.	head size (mm)
602	40 x 80
603	50 x 100
604	60 x 120
605	70 x 140
606	80 x 160
607	90 x 180

Wooden Mallets

head white beech wood material with metal coat, handle and wedge glued, ash wood handle



Art. No.	head size (mm)
0032001-1	50 x 100
0032001-2	60 x 120
0032001-3	70 x 140
0032001-4	80 x 160

Handles for Hammers, Pickaxes, Files and Shovels

Hammer Handles, made of ash wood



Art. No.	suitable for (g)	handle length (mm)	handle Ø (mm)
111.26	100	260	17 x 10
111.28	200	280	19 x 11
111.30	300	300	21 x 12
111.32	500	320	26 x 15
111.35	800	350	29 x 17
111.36	1.000	360	31 x 18
111.38	1.500	380	33 x 20
111.40	2.000	400	37 x 22
111.45	2.500	450	42 x 24
111.50	3.000	500	42 x 24

Mining Sledge Hammer Handles, made of ash wood



Art. No.	suitable for (g)	handle length (mm)	handle Ø (mm)
115.28	1.000	280	33 x 20
115.30	1.500	300	37 x 22
115.35	2.000	350	37 x 22

Sledge Hammer Handles made of ash wood



Art. No.	suitable for (g)	handle length (mm)	handle Ø (mm)
111.60	3.000	600	42 x 24
111.80	5.000	800	48 x 28
111.90	12.000	900	59 x 35

Pickaxe Handles made of beech wood



Art. No.	shape	handle length (mm)	handle Ø (mm)
44PN	oval	95	42 x 24
55PR	round	95	55
60PR	round	95	60

File Handles made of beech wood



Art. No.	handle length (mm)	handle Ø (mm)
201.80	80	18
201.90	90	20
201.100	100	22
201.110	110	25
201.120	120	28
201.130	130	30
201.140	140	32
201.150	150	34
201.160	160	36

Shovel Handles made of beech wood



Art. No.	handle length	Ø (mm)
130SH	130 cm	15 x 6

Metal Wedges



Art. No.	size	head size (mm)
3927.00	00	13
3927.0	0	16
3927.1	1	20
3927.2	2	23
3927.3	3	26
3927.4	4	29
3927.5	5	33
3927.55	5.5	40
3927.6	6	50

Pinching Bars with hexagonal shaft, made of special steel



Art. No.	size	head size (mm)
9840186	400	18
9850186	500	18
9860186	600	18
9880186	800	18
98d1186	1000	18

Trowels

Classic Smoothing Trowels

classic style, aluminium column
beechwood handle in red or blue

Art. No.	size (mm)
014.280	280 x 130 x 0.7



Notched Smoothing Trowels

classic style, aluminium column
beechwood handle in red or blue



Art. No.	size (mm)	notches
014.284	280 x 130 x 0.7	4 x 4
014.286	280 x 130 x 0.7	6 x 6
014.288	280 x 130 x 0.7	8 x 8
014.281	280 x 130 x 0.7	10 x 10



Flooring Trowels

pointed, with two aluminium columns and closed
wooden handle in red or blue

Art. No.	size (mm)
400645	450 x 90 x 70 x 1.1
400650	500 x 90 x 70 x 1.1
400660	600 x 90 x 70 x 1.1
400670	700 x 90 x 70 x 1.1



Lebanese Style Smoothing Trowels

with two steel columns and varnished wooden handle

Art. No.	size (mm)
281028	280 x 130 x 0.7



Mason Spoon Steel trowel - Walby pattern

with black lacquered wooden handle

Art. No.	size (mm)
10400	160
10410	180
10420	200
10430	220



Mason Spoon Steel trowel German square pattern

with black lacquered wooden handle



Art. No.	size (mm)
10500	160
10510	180
10520	200
10530	220



Trowels

Plastic Finishing Trowels

classic style

Art. No.	size (mm)
201428	140 x 280
201832	180 x 320
202036	200 x 360



Plastic Finishing Trowels

classic style - dark yellow

Art. No.	size (mm)
76785 1428	140 x 280
76785 1832	180 x 320
76785 2036	200 x 360



Wall Scrapers - „JUCO“ brand

made of polished spring steel with beechwood handle

Art. No.	size (mm)
810/200	200
810/250	250



Japan Scraper Sets

steel blade with plastic back
cons. of 4 pcs/set: 50/80/100/120 mm

Art. No.
85-620-000



Spatula, stainless steel blade

with plywood handle

Art. No.	width (mm)
455-25	250
455-30	300
455-40	400
455-50	500
455-60	600

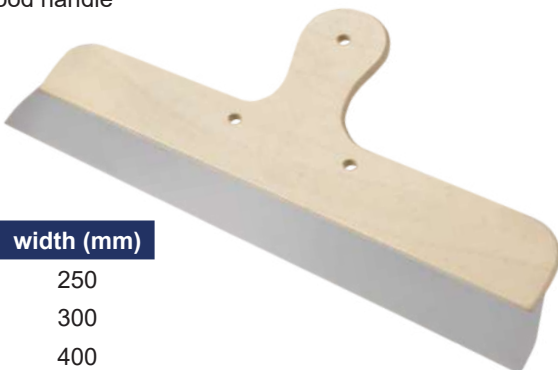

Spatula, stainless steel blade

with wooden handle

Art. No.	width (mm)
991-00	30
992-00	40
993-00	50
994-00	60
995-00	80
996-00	100
997-00	120
998-00	150





Silicone Sealant

KISTENMACHER Universal Purpose Silicone Sealant

Silicone Sealant for many applications

- Suitable for sealing, bonding, repairing and mending
- Ready to use
- Fast curing with excellent adhesion
- Weatherproof, non-aging and UV resistant
- Short tack-free time
- Permanently elastic
- High mould resistant
- Temperature resistance between -40°C - 150°C
- Long shelf life of 24 months

Genuine 280 ml / cartridge

Packing:

24 pcs / carton

1.152 pcs / pal = 48 cartons

MOQ: 5.760 pcs = 5 pal

20' = 34.560 pcs (30 pallets)

Application:

Surfaces joint edges must be stable, clean, dry and free from dust, oil and grease.

For problem surfaces, please use a primer before applying the silicone.

Do not use on natural stone, PE, PP and surfaces containing tar and bitumen.

Not suitable for structural glazing and aquarium.



KISTENMACHER „ANTI-FUNGUS“ Silicone Sealant

Silicone Sealant with fungal resistant properties for many applications

- Suitable for sealing, bonding, repairing and mending
- Ready to use
- Fast curing with excellent adhesion
- Weatherproof, non-aging and UV resistant
- Short tack-free time
- Permanently elastic
- High mould resistant
- Temperature resistance between -40°C - 150°C
- Long shelf life of 24 months

Genuine 280 ml / cartridge



Colours: all standard colours according to RAL available (e.g. white, transparent, black, grey, beige)

Keep out of reach of children

Paint Rollers

Refills for Radiator Paint Rollers - 10 cm

white with broad yellow line, glued, polyamide fabric, 10 pcs in a plastic box, then 840 pcs in a carton

Art. No.

K50.320

K50.320H incl. roller frame (Art. No. 87416 - 42 cm)

Refills for Paint Rollers - 11 cm

10 pcs. in a plastic box with label, CFC free foam, glued

Art. No.

K50.420 white colour, straight, fine quality

Refills for Paint Rollers - 11 cm

10 pcs. in a plastic box with label, CFC free foam, glued

Art. No.

K50.427 white colour, round face, fine quality

Refills for Paint Rollers - 11 cm

10 pcs. in a plastic box with label, CFC free foam, glued

Art. No.

K50.440 yellow colour, straight, for rustic wall structures with plasters or fillings

Refills for Radiator Paint Rollers - VESTAN 11 mm

white for 6 mm / roller size 10 cm

10 pcs. in a plastic box, then 500 pcs in a carton

Art. No.

5002 1100-002



Roller Frames

handle: ROTERGO green, embossed with „Made in Germany“, 20 pcs each in a carton

Art. No.	length (cm)	width (cm)
87216	27	10-12
87416	42	10-12
87616	66	10-12
87816	80	10-12
80516	30	25-27



Spike Rollers - with handle

spike-length 8 mm

to drive out air inclusions in polyester and epoxy resin coatings by rolling

Art. No.	width
797024001	24 cm
797019001	19 cm



Wallpaper Seam Rollers

complete with strong handle, 10 pcs each in a carton

Art. No.	width
510353-401	15 cm



Art. No.	width
500354-401	5 cm



Brushes & Utility Knives

Radiator Brushes

with light bristles and wooden handle (unlacquered) standard quality



Art. No.	size (mm)	size (inch)
435025-401	25	1.0"
435035-401	35	1.5"
435050-401	50	2.0"
435060-401	60	2.5"
435075-401	75	3.0"

Ceiling Brushes - Size No. 1

with synthetic bristles, plastic handle and clip, wooden body, size 170 x 70 mm
pasting work, wash off and cleaning



Art. No.	pcs per carton
7515280000	12

Ceiling Brushes - Quality DUHALON - Size No. 2

with black oval plastic body and black plastic handle with clip, pure white DUHALON bristles, length 82 mm, size 180 x 85 mm

Art. No.	pcs per carton
76232401029	12



with pure fibre bristles for Bitumen cement, lime application

Art. No.	pcs per carton
7517000000	12



Utility Knives

incl. 1 straight blade, each packed in carton box

Art. No.
1034.00-1972



SNAP-Off Knife Mozart with 18 mm blade

sturdy knife with steel blade guides, including 3 blades 180.050

Art. No.
6180.00



trapezoid blades

Art. No.	dimensions (mm)	pcs p. box
975.065	60 x 18.8 x 0.63	10



trapezoid blades

Art. No.	dimensions (mm)	pcs p. box
900.065	53 x 18.8 x 0.63	10



hook blades

Art. No.	dimensions (mm)	pcs p. box
110.065	51 x 18.8 x 0.63	10



Snap-off blades - 18 mm

Art. No.	dimensions (mm)	pcs p. box
180.050	109.4 x 18 x 0.50	10



Tile Cutting Machines with steel base plate



Art. No.	cutting length	tile thickness	Ø (mm)
115	300 mm	10 mm	15 x 6



Art. No.	cutting length	tile thickness	Ø (mm)
166	400 mm	15 mm	15 x 6



with angle adjustment

Art. No.	cutting length	tile thickness	Ø (mm)
153	470 mm	18 mm	22 x 6
154	600 mm	18 mm	22 x 6



with angle adjustment

Art. No.	cutting length	tile thickness	Ø (mm)
158	800 mm	18 mm	22 x 6



with angle adjustment and linear ball bearings

Art. No.	cutting length	tile thickness	Ø (mm)
163	470 mm	18 mm	22 x 6
164	600 mm	18 mm	22 x 6

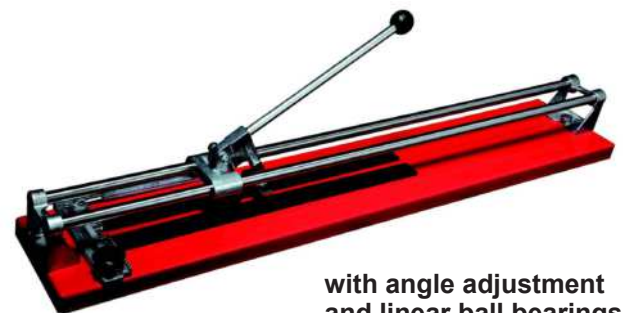

with angle adjustment and linear ball bearings

Art. No.	cutting length	tile thickness	Ø (mm)
165	800 mm	18 mm	22 x 6

Carbide Cutting Wheels, ground



Art. No.	Ø (mm)
053	22 x 6



Art. No.	Ø (mm)
054	15 x 6

Carbide Tile-Hole Cutter

Art. No.	drilling range
600	30 - 80 mm



Tile Spacer and Cork Pads

Tile Spacers

in poly bag

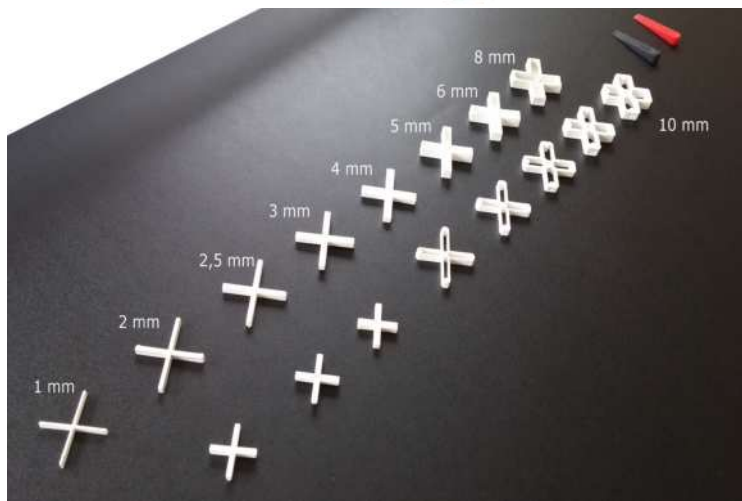

Art. No. 250 pcs/bag	Art. No. 200pcs/bag	Art. No. 100 pcs/bag	size (mm)
20250L	20200L	20100L	2 x 28
25250L	25200L	25100L	2.5 x 28
30250L	30200L	30100L	3 x 28
40250	40200	40100	4 x 22
50250	50200	50100	5 x 22
60250	60200	60100	6 x 24
---	80200	80100	8 x 30
---	---	10100	10 x 30



Cork Inseal Pads

on roll with paper lay self-adhesive, cork stacking discs are ideal spacers for glass, plastics, wood and many other sensitive surfaces, simple to use as transport and storage protection, easy to remove again

Art. No.	size	thickness	pcs/carton
L5507-2	15 x 15	6 mm	60.000
L5507-3	18 x 18	8 mm	30.000



White Polyurethane Foam Tapes

fine open-cell, with brown PVC backing, not UV-resistant, highly compressible and very adaptable



Art. No. thickness 6 mm	width (mm)	length (m)	pcs/ carton
14003-03/12	12	10	25
14003-03/15	15	10	20
14003-03/19	19	10	16
14003-03/25	25	10	12
14003-03/30	30	10	10

Art. No. thickness 8 mm	width (mm)	length (m)	pcs/ carton
14003-03/15/8	15	7.5	20
14003-03/19/8	19	7.5	16
14003-03/25/8	25	7.5	12

Art. No. thickness 9 mm	width (mm)	length (m)	pcs/ carton
14003-03/9/9	9	5	33

Art. No. thickness 10 mm	width (mm)	length (m)	pcs/ carton
14003-03/19/10	19	10	16

Glass Tools

VERIBOR Suction Lifters blue line

the strong durability of aluminium combined with synthetic material is a trademark of this suction lifter

- suitable for all materials with flat and airtight surfaces such as glass, plastic, metal, coated wood and marble
- suction pad Ø: 120 mm



Art. No. 600.0BL



Art. No. 602.0BL

Art. No.	load cap.	cups
600.0BL	30 kg	1 cup - one hand
602.0BL	70 kg	2 cup - transverse handle
602.421	60 kg	2 cup - lengthwise handle
603.021	100 kg	3 cup



Art. No. 602.421



Art. No. 603.021

VERIBOR Suction Lifters

traditional design of strong aluminium body

- suitable for all materials with flat and airtight surfaces such as glass, plastic, metal, coated wood and marble

Art. No.	load cap.	cups
600.0	30 kg	1 cup - one hand
601	120 kg	1 cup - one hand - pump activated - visual vacuum monitoring



Art. No. 600.0



Art. No. 601

VERIBOR Suction Lifters, plastic construction

- suitable for all materials with flat and airtight surfaces such as glass, plastic, metal, coated wood and marble
- suction pad Ø: 120 mm



Art. No. 600.1G



Art. No. 602.1G

Art. No.	load cap.	cups
600.1G	25 kg	1 cup - one hand
602.1G	50 kg	2 cup - lengthwise handle

Glass Tools



Glass Cutters SILBERSCHNITT

for glass thickness from 3 to 10 mm.
6 cutting wheels made of alloyed steel and tempered by a patented method guarantee high cutting quality and long service life.
Turrets and cutting heads are nickel plated.

Art. No.
100.0



Carbide Glass Cutters

especially suitable for thick and hard glass,
wooden handle, replaceable, tempered turret with carbide wheel Ø 5 mm,
especially selected carbide metal guarantees high wear-resistance

Art. No. glass thickness
400.0 3-6 mm



Carbide Glass and Tile Cutters

cutting angle 135°,
ergonomically shaped, plastic handle especially suitable to cut tiles requiring high cutting pressure, tempered turret with one carbide wheel 5 mm

Art. No. glass thickness
410.0 3-8 mm



JOBO Glass Cutters

6 cutting wheels made of special steel,
round wooden handle, straight edge stand-off distance 2,5 mm

Art. No.
320.0



Spare Turrets with 6 Steel Wheels

suitable for all SILBERSCHNITT glass and circle cutters 511.0 - 516.0

Art. No.
101.0



Spare Wheels

stainless steel, especially tempered suitable for all SILBERSCHNITT glass and circle cutters

Art. No.
102.0 in practical dispenser of 10 doz
102.1 in dozens on a needle in plastic bag



Oil Glass Cutters

original TOPLIFE quality with extended service life,
handle with finger grip

Art. No.
5000.0 brass, wide head
4000.1 brass, narrow head
3001.0 plastic, wide head
3001.1 plastic narrow head

Art. No.
5000.0



Art. No.
4000.1



Art. No.
3000.0
3001.0

Glass Tools

Bohle



Cutting Heads - Spare

for all SILBERSCHNITT oil glass, wide or narrow plate, cutting angle 138°

Art. No.

- 4010.1 narrow cutting head
- 5010.0 wide plate



4010.1



5010.0

Circle Cutters with ball-bearing cutting head

trailing carbide wheel in TOPLIFE quality

- improved break quality even for small radii
- long service life
- less cutting pressure
- diameter, min. 72 mm
- cutting angle: 135°
- 2-6 mm glass thickness

Art. No.

- 511.5 diameter: 60 cm
- 514.5 diameter: 120 cm
- 516.5 diameter: 200 cm
- 518.5 metal wheel holder spare head



Circle Cutters with 6 steel wheels

- cutting angle: 130°
- wheels and turret can be easily exchanged
- 3-6 mm glasstickness

Art. No.

- 511.0 diameter: 60 cm
- 514.0 diameter: 120 cm
- 516.0 diameter: 200 cm
- 518.0 spare cuttinghead



Glass Breaking Pliers

ground head, plastic coated handle, lacquered finish

Art. No.	length	colour	jaw width
50 081 18	180 mm	black	24 mm
50 080 20	200 mm	black	24 mm
50 081 20	200 mm	blue	20 mm



50 081 18
50 080 20



50 081 20

Putty Knives

brown polished wooden handle, blade: 26 mm wide

Art. No.

- 51 621 00 highly polished continuous blade, blade length 110 mm
- 51 623 00 highly polished continuous blade, blade length 110 mm
- 51 623 01 highly polished continuous blade, spear point, blade length 110 mm
- 51 624 00 highly polished continuous blade, spear point, blade length 105 mm



Glass Tools

Bohle



JOBO Carpet Grippers

- aluminium, for carpeted double floors
- 2 cup - lengthwise handle

Art. No.

619.9



Verifix UVA-Star 500, 1110, 1410

for stress-free curing of bended edges, 230 Volts, white light

Art. No.

- 55 003 80 working length 500 mm, 18W
- 55 003 85 working length 1100 mm, 36W
- 55 003 90 working length 1410 mm, 58W

Product Highlights:

- state-of-the-art technology, new design
- energy and time saving
- easy to use
- particularly suitable for glass / glass edge bonding



UV Curing Adhesives - Verifix B 665-0

this UV adhesive is crystal-clear and thin-bodies (low viscosity) - it displays very good capillary properties allowing it to be applied from the outside and penetrating into the gap of pre-assembled parts by itself - not waterproof over time

Art. No.

- 52 093 24 content 1000g
- 52 093 21 content 250g
- 52 093 00 content 100g
- 52 093 27 content 20g



Glass Carrying Gloves PowerGrab KEVLAR® KEV4

KEVLAR® cut resistant gloves with open-pored MicroFinish® latex coating to provide optimum grip

breathable material on back of hand
also available with extended wrist protection
tested per DIN EN 388 CAT II



Art. No.

- 50 175 10 (L)
- 50 175 09 (XL)



Glass Carrying Gloves

seamless cotton/polyester fabric, palm and fingertips with blue latex coating

good protection against mechanical risks
tested per DIN EN 388 CAT II



Art. No.

- 50 175 18 (L)
- 50 175 17 (XL)



L-Squares

L-Squares without brace

made of high-quality material with two pegs made of blue plastic allowing the glass edge to be fully visible when positioned

Art. No.	length (cm)	width (cm)	colour
029.00	30	17	without pegs - black
029.5	30	17	black
030.5	50	27	grey
031.5	60	27	grey
032.5	80	37	grey
033.5	105	37	grey
034.5	135	47	grey
035.5	150	47	grey
036.5	175	47	grey



L-Squares with brace - black

made from one piece of high-quality material

Art. No.	length (cm)	width (cm)
031.1	60	30
032.1	80	34
033.1	105	40
034.1	135	45
035.1	150	45
036.1	175	50
037.1	205	60
038.1	250	70



Joiner's Square

with mitre, with two graduations

light version

steel blade 30 mm

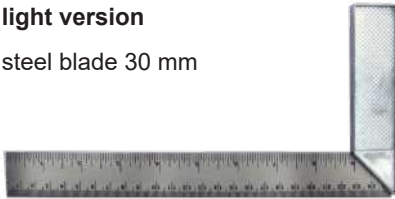

Art. No.	length (mm)
1020150	150
1020200	200
1020250	250
1020300	300
1020350	350
1020400	400

heavy version

steel blade 35 mm

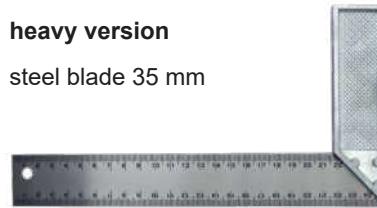

Art. No.	length (mm)
1110150	150
1110200	200
1110250	250
1110300	300
1110350	350
1110400	400

Steel Square

carbon steel, zinc plated

without back



Art. No. w/o back	blade width (mm)	size (mm)
1200100	20	100 x 70
1200150	20	150 x 100
1200200	20	200 x 130
1200250	25	250 x 160
1200300	25	300 x 180
1200400	25 / 30	400 x 230
1200500	25 / 30	500 x 280
1200600	30	600 x 330
1200800	30	800 x 430
1201000	30	1000 x 500

with back

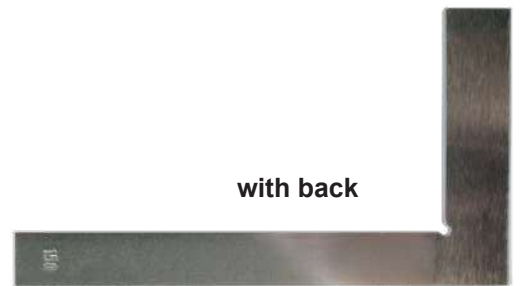

Art. No. with back	blade width (mm)	size (mm)
1300100	20	100 x 70
1300150	20	150 x 100
1300200	20	200 x 130
1300250	25	250 x 160
1300300	25	300 x 180
1300400	25	400 x 230
1300500	25	500 x 280
1300600	30	600 x 330
1300800	30	800 x 430
1301000	30	1000 x 500

Squares

Try Square - Powder Coated

made of hardened spring steel, 40 x 1.2 mm, with mm-graduation.
support blade made of black anodised aluminium profile, L-form 40 x 14 mm.
powder coated in yellow (RAL 1021)

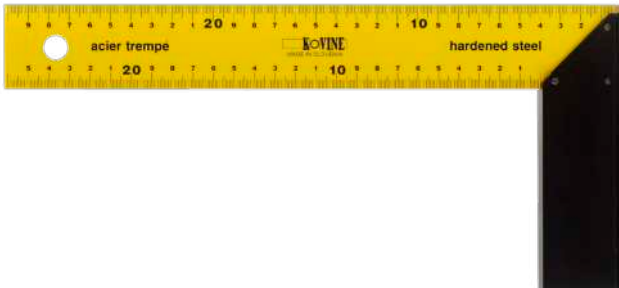

Art. No.	dimensions (mm)
KMI200	200 x 125
KMI250	250 x 135
KMI300	300 x 135
KMI350	350 x 190
KMI400	400 x 190
KMI500	500 x 210

Carpenter's Square - Powder Coated

made of hardened spring steel, 35 x 1.5 mm, with mm-graduation.
powder coated in yellow (RAL 1021)

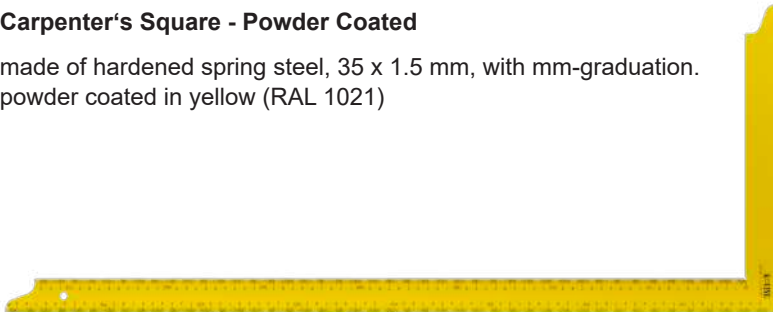

Art. No.	dimensions (mm)
KTB500	500 x 250
KTB600	600 x 280
KTB700	700 x 300
KTB800	800 x 320
KTB900	900 x 340
KTB1000	1000 x 360

Carpenter's Square - zinc Coated

made of hardened spring steel, 35 x 1.5 mm, with mm-graduation.
zinc coated



Art. No.	dimensions (mm)
KTC500	500 x 250
KTC600	600 x 280
KTC700	700 x 300
KTC800	800 x 320
KTC900	900 x 340
KTC1000	1000 x 360

Try Square 45° - Powder Coated

made of hardened spring steel, 40 x 1.2 mm.
support blade made of black anodised aluminium profile, L-form 40 x 1.4 mm.
for measuring of angles 45° and 135° powder coated in yellow (RAL 1021).



Art. No.	length (mm)
KMS250	250

Clamps & Joiner's Squares

Joiner's Squares

with die-cast stock and mm-graduation,
light execution,
steel blade 32 mm width - INOX blade 30 mm width

Art. No.	length (mm)	Art. No. INOX	length (mm)	Material
123120	200	122120	200	stainless steel blade
123125	250	122125	250	stainless steel blade
123130	300	122130	300	stainless steel blade
123135	350			
123140	400			

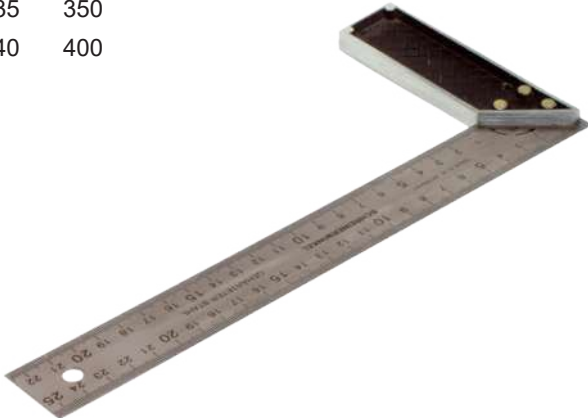

Joiner's Squares

with beech wood stock, blue steel blade
and mm-graduation
blade 40 mm width

Art. No.	length (mm)
102125	250
102130	300
102140	400

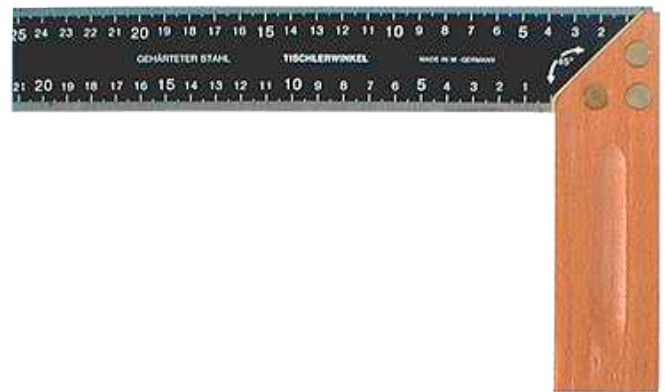

BESSEY Door Clamps

with T-profile
colour: black

Art. No. Type A	Art. No. Type B	length
TAN 80		800
	TB 100	1000
TAN 120	TB 120	1200
TAN 150	TB 150	1500
TAN 210	TB 210	2100
TAN 250	TB 250	2500

A) Sash clamp TAN with L-profile, 80 x 42 x 3.9 mm,
easy adjustable jaws, with stopping bolt,
Type TAN - force 24.000 N

B) Sash clamp TB with T-profile 40 x 40 x 5 mm
with locking bolt, Type TB - force 14.000N



KISTENMACHER brand C-Clamps

made of high grade, drop forged steel, galvanized
with fine thread spindle

Art. No.	Clamping capacity	throat capacity
420-028	28	25
420-053	53	38
420-078	78	50
420-105	105	60
420-130	130	70
420-155	155	76
420-206	206	86



F-clamps

KISTENMACHER brand cast iron F-Clamps,

galvanized grooved hollow section bar, black clamp, with red coloured wooden handle and protective caps

Art. No.	size (mm)	rail (mm)
21100	100x50	15x5
21101	120x60	22x6
21102	160x80	25x6
21103	200x100	30x8
21104	250x120	30x8
21105	300x140	35x9
21106	400x175	35x9
21199	400x120	35x11
21200	500x120	35x11
21201	600x120	35x11
21202	800x120	35x11
21203	1000x120	35x11
21204	1250x120	35x11
21205	1500x120	35x11
21206	2000x120	35x11
21207	2500x120	35x11
21208	3000x120	35x11



KISTENMACHER brand cast iron F-Clamps,

galvanized grooved hollow section bar, silver galvanized clamp, with red coloured wooden handle and protective caps

Art. No.	size (mm)	rail (mm)
11100	100x50	15x5
11101	120x60	22x6
11102	160x80	25x6
11103	200x100	30x8
11104	250x120	30x8
11105	300x140	35x9
11106	400x175	35x9
11199	400x120	35x11
11200	500x120	35x11
11201	600x120	35x11
11202	800x120	35x11
11203	1000x120	35x11
11204	1250x120	35x11
11205	1500x120	35x11
11206	2000x120	35x11
11207	2500x120	35x11
11208	3000x120	35x11



KISTENMACHER brand cast iron F-Clamps,

galvanized grooved hollow section bar, black clamp, with blue-black coloured Power-Grip handle and protective caps

Art. No.	size (mm)	rail (mm)
22100	100x50	15x5
22101	120x60	22x6
22102	160x80	25x6
22103	200x100	30x8
22104	250x120	30x8
22105	300x140	35x9
22106	400x175	35x9
22199	400x120	35x11
22200	500x120	35x11
22201	600x120	35x11
22202	800x120	35x11
22203	1000x120	35x11
22204	1250x120	35x11
22205	1500x120	35x11
22206	2000x120	35x11
22207	2500x120	35x11
22208	3000x120	35x11



KISTENMACHER brand cast iron F-Clamps,

galvanized grooved hollow section bar, silver galvanized clamp, with blue-black coloured Power-Grip handle and protective caps

Art. No.	size (mm)	rail (mm)
52100	100x50	15x5
52101	120x60	22x6
52102	160x80	25x6
12103	200x100	30x8
12104	250x120	30x8
12105	300x140	35x9
12106	400x175	35x9
12199	400x120	35x11
52200	500x120	35x11
52201	600x120	35x11
52202	800x120	35x11
12203	1000x120	35x11
12204	1250x120	35x11
12205	1500x120	35x11
12206	2000x120	35x11
12207	2500x120	35x11
12208	3000x120	35x11



Hand Saws



Baghdad Hand Saws

with wooden rivetted handle,
lacquered



Art. No.	length (mm/Inch)	tpl
119/400	400 / 16"	7
119/450	450 / 18"	7



Hand Saws

with closed wooden rivetted handle,
lacquered



Art. No.	length (mm/Inch)	tpl
612/300	300 / 12"	8
612/350	350 / 14"	8
612/400	400 / 16"	7
612/450	450 / 18"	7
612/500	500 / 20"	7
612/550	550 / 22"	7



Pruning Saws

with wooden handle, thickness
of blade 0.7 mm



Art. No.	length (mm/Inch)	tpl
631/300	300 / 12"	5
631/350	350 / 14"	5
631/400	400 / 16"	5



TCT Hand Saws

with carbide tipped teeth and
closed wooden handle



Art. No.	length (mm/Inch)	tpl
903/17	700 / 28"	17
903/34	700 / 28"	34



Hand Saws & Fretsaws



Junior Hack Saws

with red beechwood handle, zinc-plated frame made of 6 mm round steel, fitted with a PUK universal saw blade



Art. No.	length
305100	290 mm

Metal Bar Saws

black powder coated with beechwood handle, fitted with a PUK bi-metal sawblade 300 mm / 24 tpi



Art. No.	length
B31102	510 mm

Fret Saw Frames

extremely solid, made of 13 mm round steel, black coated with red beechwood handle



Art. No.	length (mm/Inch)
490001	345 / 13.8

Fret Saw Blades for wood

- TAIFUN version: packing with yellow cover at both ends
- TORNADO version: packed in plastic foil
- CRAFTA version: packing with light blue cover at both ends



No.	Art. No.	Art. No.	Art. No.	Art. No.	Art. No.	Art. No.
	TAIFUN double teeth	TAIFUN skip teeth	TAIFUN spiral teeth	CRAFTA double teeth	CRAFTA skip teeth	CRAFTA regular teeth
mixed	501920	511920		601920	611920	621920
2/0	502020	512020	E524016	602020	612020	622020
0	500020	510020	E524010	600020	610020	620020
1	500120	510120	E524011	600120	610120	620120
2	500220	510220	E524012	600220	610220	620220
3	500320	510320	E524013	600320	610320	620320
4	500420	510420	E524014	600420	610420	620420
5	500520	510520	E524015	600520	610520	620520
7	500720	510720		600720	610720	620720
9	500920	510920		600920	610920	620920
11	501120	511120		601120	611120	621120
12		511220			611220	





Hand Hack Saw Blades

KISTENMACHER brand Universal Hand Hack Saw Blades

made of alloyed steel - flexible
single sided toothing with wavy setting
suited for steel cutting

10 pcs/bundle - 100 pcs/blue box - 10 boxes/carton



Art. No.	size (mm)	tpi
SF-D08-100	300 x 13 x 0,65	18
SF-D10-100	300 x 13 x 0,65	24
SF-D12-100	300 x 13 x 0,65	32



KISTENMACHER brand HSS-BI Metal Hand Hack Saw Blades

made of super-alloyed high speed steel - super flexible
single sided toothing with wavy setting
suited for steel cutting

10 pcs/bundle - 100 pcs/orange box - 10 boxes/carton



Art. No.	size (mm)	tpi
HSSM2-D08-100	300 x 13 x 0,65	18
HSSM2-D10-100	300 x 13 x 0,65	24
HSSM2-D12-100	300 x 13 x 0,65	32



GLOBUS brand Hand Hack Saw Blades

carbon steel, single sided or double sided toothing

Rama: 144 pcs/cartonbox - 20 cartonboxes in wooden case
RAMb: 72 pcs/cartonbox - 20 cartonboxes in wooden case
RAMc: 144 pcs/cartonbox - 20 cartonboxes in wooden case



Art. No.	size (mm)	tpi	toothing	pcs/carton
RAMa	300 x 12.5 x 0.6	24	single sided	144
RAMb	300 x 25.0 x 0.6	24	double sided	72
RAMc	300 x 12.5 x 0.6	24	double sided	144



Other sizes and tpi available upon request

G-MAN brand Hand Hack Saw Blades

single sided toothing made of carbon steel

10 pcs/bundle - 100 pcs/grey box - 10 boxes/carton



Art. No.	size (mm)	tpi
3040-3024GM	300 x 12.5 x 0.60	24



Hand Saws and Bow Saw Blades

G-MAN brand HSS flexible Hack Saw Blades
single sided toothing

10 pcs/bundle - 100 pcs/grey box - 10 boxes/carton



Art. No.	size (mm)	tpi
3042-3042GM	300 x 12.5 x 0.60	24



G-MAN brand BI-metal Hack Saw Blades
single sided toothing

10 pcs/bundle - 100 pcs/grey box - 10 boxes/carton



Art. No.	size (mm)	tpi
3003-3018GM	300 x 12.5 x 0,60	18
3003-3024GM	300 x 12.5 x 0,60	24
3003-3032GM	300 x 12.5 x 0,60	32



G-MAN brand Universal Hand Saws Classic U7
with a comfortable plastic handle with 3 screws,
supplied in hard point finish



Art. No.	size (inch/mm)
328H16U7	16/400
328H18U7	18/450
328H20U7	20/500
328H22U7	22/550
328H24U7	24/600



cutBRIK brand Bow Saws

with yellow steel frame and black quick release,
including saw blades No. 18

Art. No.	size (inch/mm)
15 B18-300	12/300



Art. No.	size (inch/mm)
50 B18-610	24/610
50 B18-762	30/762
50 B18-914	36/914



cutBRIK brand Hack Saws
with yellow steel fram and black handle

bi-metal blade



Art. No.	size (Inch/mm)
16 B18-300	12/300



cutBRIK brand Saw Blades for Bow Saws

200 pcs per box

- a) Ref. 10 for dry wood
- b) Ref. 18 for green wood

Art. No.	size (inch/mm)
10 / 18	12/300
10 / 18	18/460
10 / 18	21/533
10 / 18	24/610
10 / 18	30/762



Circular Saw Blades



EDN brand Carbide Tipped Circular Sawblades

- for cutting wood
- for cutting aluminium - negative teeth

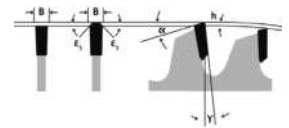
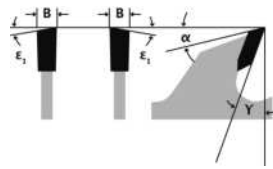

WOOD Art. No. 76950...	ALUMINIUM Art. No. 76956...	teeth	size x width (mm)	WOOD Art. No. 76950...	ALUMINIUM Art. No. 76956...	teeth	size x width (mm)	WOOD Art. No. 76950...	ALUMINIUM Art. No. 76956...	teeth	size x width (mm)
150024		24	150 x 3.0	250024		24	250 x 3.2	350120	350120	120	350 x 3.6
150030		30	150 x 3.0	250030		30	250 x 3.2	400048		48	400 x 3.6
150036		36	150 x 3.0	250040		40	250 x 3.2	400060		60	400 x 3.6
150048	150048	48	150 x 3.0	250048		48	250 x 3.2	400072	400072	72	400 x 3.6
160036		36	160 x 2.5	250060	250060	60	250 x 3.2	400084		84	400 x 3.6
160048		48	160 x 2.5	250080	250080	80	250 x 3.2	400096	400096	96	400 x 3.6
180024		24	180 x 3.0		250096	96	250 x 3.2	400108	400108	108	400 x 3.6
180030		30	180 x 3.0	300028		28	300 x 3.2	400120	400120	120	400 x 3.6
180036		36	180 x 3.0	300036		36	300 x 3.2	400132		132	400 x 3.6
180042		42	180 x 3.0	300048	300048	48	300 x 3.2	450066		66	450 x 4.0
180048		48	180 x 3.0	300060	300060	60	300 x 3.2	450072		72	450 x 4.0
180056		56	180 x 3.0	300072	300072	72	300 x 3.2	450084		84	450 x 4.0
200034		34	200 x 3.0	300084	300084	84	300 x 3.2	450096	450096	96	450 x 4.0
200042		42	200 x 3.0	300096	300096	96	300 x 3.2	450108	450108	108	450 x 4.0
200048		48	200 x 3.0	350036		36	350 x 3.6	450120	450120	12	450 x 4.0
200064	200064	64	200 x 3.0	350042		42	350 x 3.6	450132	450132	132	450 x 4.0
230034		34	230 x 3.0	350048		48	350 x 3.6	500072		72	500 x 4.0
230042		42	230 x 3.0	350054		54	350 x 3.6	500096	500096	96	500 x 4.0
230048		48	230 x 3.0	350060		60	350 x 3.6	500120	500120	120	500 x 4.0
230060		60	230 x 3.0	350072	350072	72	350 x 3.6				
230064		64	230 x 3.0	350084	350084	84	350 x 3.6				
230072	230072	72	230 x 3.0	350096	350096	96	350 x 3.6				
230080	230080	80	230 x 3.0	350108	350108	108	350 x 3.6				

Other sizes are available upon request





Circular Saw Blades

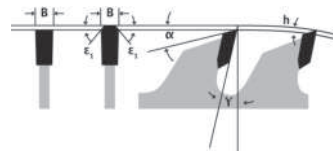

EDN brand Carbide Tipped Circular Sawblades

Type 061 VTF

- for cutting single- and double-sided plastic coated panel materials

Art. No.	teeth	size x width (mm)
061 VTF 180048	48	180 x 3.2
061 VTF 200064	64	200 x 3.2
061 VTF 230072	72	230 x 3.2
061 VTF 250080	80	250 x 3.2
061 VTF 300096	96	300 x 3.2
061 VTF 350108	108	350 x 3.5

EDN[®]

euronorm quality

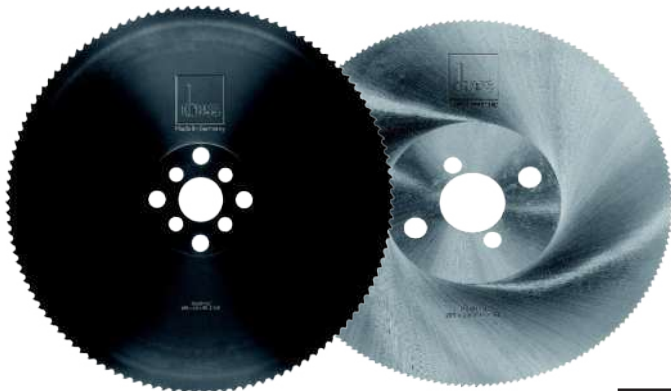

DRESS brand Metal Cutting Circular Sawblades

made of HSS /DMo5 for sawing machines, vaporized

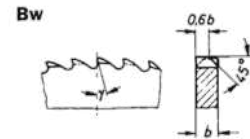

Art. No.	teeth	size x width (mm)
725025G	250	250 x 2,5
730030G	300	300 x 2,5

Other sizes and several bore diameters are available upon request

KISTENMACHER brand Power Hacksaw Blades

blades are hardened and tempered for maximum cutting performance.
Tooth tips made of top high-speed steel M2 - regular setting



Dimensions	TPI	box packing
300x25x1,2mm	6,8,10,14	50
350x32x1,6mm	4,6,8,10,14	50
400x32x1,6mm	4,6,8,10,14	50
450x32x1,6mm	4,6,8,10,14	30
400x40x2,0mm	4,6,8,10	50
450x40x2,0mm	4,6,8,10	30
500x40x2,0mm	4,6,8,10	30
550x50x2,5mm	4,6,8,10	20
600x50x2,0mm	6,8,10	20
600x50x2,5mm	4,6,8,10	20
650x50x2,5mm	4,6,8,10	10
700x50x2,5mm	4,6,8,10	10



Band Saw Blades & Planer Blades



Band saws for cutting wood

made of special steel CR-300, hardened, polished, toothed NV (A), set-machine sharp

available on rolls of 22, 25 and 50 m



Art. No.	size
120606/R	12 x 0,6 x 6 mm
150606/R	15 x 0,6 x 6 mm
200606/R	20 x 0,6 x 6 mm
200607/R	20 x 0,6 x 7 mm
200608/R	20 x 0,6 x 8 mm
200708/R	20 x 0,7 x 8 mm
250608/R	25 x 0,6 x 8 mm
250708/R	25 x 0,7 x 8 mm

Art. No.	size
300709/R	30 x 0,7 x 9 mm
300809/R	30 x 0,8 x 9 mm
350810/R	35 x 0,8 x 10 mm
400810/R	40 x 0,8 x 10 mm
400910/R	40 x 0,9 x 10 mm
450811/R	45 x 0,8 x 11 mm
500912/R	50 x 0,9 x 12 mm
601014/R	60 x 1,0 x 14 mm

Remark:
available in set and sharpened or unset versions

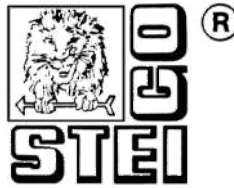

KISTENMACHER brand Planer Blades Chrome-vanadium steel (C75 48-50 HRC)



Art. No.	size/length (inch/mm)
250353	10" / 250 x 35 x 3
300353	12" / 300 x 35 x 3
350353	14" / 350 x 35 x 3
400303	16" / 400 x 30 x 3
400353	16" / 400 x 35 x 3
450353	18" / 450 x 35 x 3
450303	20" / 500 x 30 x 3
500353	20" / 500 x 35 x 3
550353	22" / 550 x 35 x 3
550303	24" / 600 x 30 x 3
600353	24" / 600 x 35 x 3
800353	36" / 800 x 35 x 3

KISTENMACHER brand Turnblade Knives cutting angle 35°



Art. No.	size (mm)	packing unit
K-KCR08	HW 50 x 12 x 1.5	10 pcs / box

Other sizes available upon request

Lifting Equipment

Mechanical Rack Jacks

with safety crank,
blue lacquered



Art. No.	capacity (ton)
15-00/2.5	2.5
15-00/5	5.0
15-01/10	10
15-01/16	16
Z23	20

Rope Hoist Type 30

blue lacquered, incl.
steel rope with hook
(packed separately)



Art. No.	capacity (ton)	rope length (m)
30-10/20	0.8	20
30-10/40	0.8	40
30-10	-	w/o rope
30-00/20	1.6	20
30-00/40	1.6	40
30-00	-	w/o rope
30-11/20	3.2	20
30-11/40	3.2	40
30-11	-	w/o rope



Lever Jacks

with link chain
Type „RZC“,
1.5 m lifting



Art. No.	capacity (ton)
RZC0.8	0.8
RZC1.6	1.6
RZC3.2	3.2
RZC5.0	5.0



Pioneer Pipe Vice Stand

Universal stand-mounted steel pipe vice
with hardened steel jaws, stable floor,
easily transportable and ready set up and
varnished body, red colour

range: 1/4" - 3"

Art. No.	range (inch)
Pioneer 03	1/4" - 3"



THIELE Brand Steel Chains Grade 80

class 8, made of alloy steel, acc. to
German standard DIN 5687-8,
elongation at break-point 17%,
black coloured, goods are packed in drums,
with test certificate

Art. No.	working load (ton)	trade size (mm)
F01465	2.0	8-8
F01470	3.15	10-8
F01475	5.3	13-8
F01480	8.0	16-8
F01485	10.0	18-8
F01490	12.5	20-8
F01500	15.0	22-8
F01515	21.2	26-8
F01525	31.5	32-8



Lifting Equipment



Oblong Master Links TWN 0831

for single leg slings, red



Art. No.	working load (ton)	D (mm)	trade size (mm)
F12008	1.12	13	6-8
F12012	2.00	16	8-8
F12018	3.15	18	10-8
F12034	5.3	22	13-8
F12052	8.0	26	16-8
F12094	10.0	32	18-8
F12116	12.5	36	20-8
F12120	15.0	36	22-8
F12168	21.2	45	26-8
F12172	25.0	45	28-8
F12198	31.5	50	32-8
F12226	40.0	56	36-8
F12244	50.0	63	40-8

Oblong Master Links TWN 0832

for double leg slings, red



Art. No.	working load (ton)	D (mm)	trade size (mm)
F12014	1.6	13	6-8
F12020	2.8	18	8-8
F12036	4.25	22	10-8
F12054	7.5	26	13-8
F12096	11.2	32	16-8
F12118	14.0	36	18-8
F12152	17.0	40	20-8
F12170	21.2	45	22-8
F12200	30.0	50	26-8
F12202	33.5	50	28-8
F12228	45.0	56	32-8
F12246	56.0	63	36-8
F12250	71.0	71	40-8

Master Link Assemblies TWN 0831

for 3- and 4-leg slings, red



Art. No.	working load (ton)	D (mm)	trade size (mm)
F12342	2.36	18	6-8
F12354	4.25	22	8-8
F12362	6.7	26	10-8
F12398	11.2	32	13-8
F12422	17.0	36	16-8
F12452	21.2	45	18-8
F12468	26.5	50	20-8
F12472	31.5	50	22-8
F12482	45.0	56	26-8
F12488	50.0	63	28-8
F12492	67.0	71	32-8
F12498	85.0	80	36-8
F12502	106.0	90	40-8

Chain Connectors Type „KWS“ grade 80

retainer electro
galvanized, red



Art. No.	working load (ton)	trade size (mm)
Z07400	1.12	5/6-8
Z07401	2.0	7/8-8
Z07402	3.15	10-8
Z07403	5.3	13-8
Z07404	8.0	16-8

THI-LOK Connectors TWN 0829



Art. No.	working load (ton)	trade size (mm)
F30800	1.12	6-8
F30005	1.5	7-8
F30810	2.0	8-8
F30820	3.15	10-8
F30830	5.3	13-8
F30840	8.0	16-8
F30850	10.0	18-8
F30855	12.5	20-8
F30860	15.0	22-8
F30870	21.2	26-8
F30880	31.5	32-8

Special Bolt Shackles TWN 0870



Art. No.	working load (ton)	trade size (mm)
F30311	3.15	10-8
F30321	5.3	13-8
F30331	8.0	16-8
F30341	12.5	18/20-8
F30351	15.0	22-8
F30361	21.2	26-8
F30371	25.0	28-8
F30381	31.5	32-8
F30391	40.0	36-8
F30401	50.0	40-8
F30411	63.0	45-8



Lifting Equipment

**Self-Locking Eye Hooks
TWN 0798, red**

Art. No.	working load (ton)	trade size (mm)
Z07274	1.12	6-8
Z07275	2.0	7/8-8
Z07276	3.15	10-8
Z07277	5.3	13-8
Z07278	8.0	16-8
F092255	12.5	18/20-8
F092275	15.0	22-8

**Self-Locking Clivis Hooks
TWN 0799, red**

Art. No.	working load (ton)	trade size (mm)
Z07279	1.12	6-8
Z07280	2.00	8-8
Z07281	3.15	10-8
Z07282	5.3	13-8
Z07296	8.0	16-8
F0922055	12.5	18/20-8

**Swivel Hooks
TWN 0854**

with safety latch, red



Art. No.	working load (ton)	trade size (mm)
F32100	1.12	6-8
F32110	2.00	8-8
F32120	3.15	10-8
F32130	5.3	13-8
F32140	8.0	16-8

**„SOLIDO“ - Eye Slip Hooks
TWN 0858/1**

with safety latch, red



Art. No.	working load (ton)	trade size (mm)
F329010	1.12	6-8
F329110	2.0	8-8
F329210	3.15	10-8
F329310	5.3	13-8
F329410	8.0	16-8
F329510	12.5	18/20-8
F329710	15.0	22-8
F329810	21.2	26-8
F329910	31.5	32-8

**Sling Hooks
TWN 0835/1**

with pin coupling and safety latch, red



Art. No.	working load (ton)	trade size (mm)
F336010	1.12	6-8
F336110	2.0	8-8
F336210	3.15	10-8
F336310	5.3	13-8
F336410	8.0	16-8
F336510	10.0	18-8
F33656	12.5	20-8
F336610	15.0	22-8

**Shortening / Grab Hooks
TWN 0827/1**

cradle type with pin coupling and safety device, red



Art. No.	working load (ton)	trade size (mm)
F33201	2.0	8-8
F33211	3.15	10-8
F33221	5.3	13-8
F33231	8.0	16-8
F33246	12.5	20-8





Spirit Levels



Strong aluminium box section, 22/50 mm, sharp-edged, extruded, heat cured, with torsional stiffness, usable as a drawing aid on all sides



SHARP EDGES

NIVEAU NORM Type 95

strato-silver anodized
1 horizontal vial,
1 vertical vial

NIVEAU NORM Type 85

powder-coated in signal colour
1 horizontal vial,
1 vertical vial

NIVEAU NORM Type 95M

strato-silver anodized
1 horizontal vial,
1 vertical vial
with strong magnets

NIVEAU NORM Type 85M

powder-coated in signal colour
1 horizontal vial,
1 vertical vial
with strong magnets

Art. No.	length (cm)
95030	30
95040	40
95050	50
95060	60
95070	70
95080	80
95090	90
95100	100
95120	120
95150	150
95180	180
95200	200

Art. No.	length (cm)
85030	30
85040	40
85050	50
85060	60
85070	70
85080	80
85090	90
85100	100
85120	120
85150	150
85180	180
85200	200

Art. No.	length (cm)
95030M	30
95040M	40
95050M	50
95060M	60
95070M	70
95080M	80
95090M	90
95100M	100
95120M	120
95120M	150
95150M	180
95200M	200

Art. No.	length (cm)
85030M	30
85040M	40
85050M	50
85060M	60
85070M	70
85080M	80
85090M	90
85100M	100
85120M	120
85150M	150
85190M	180
85200M	200

available at a surcharge:
3rd vial 90°
3rd vial 45°

alternatively
horizontal vial with 2 additional rings
for setting out 2% slopes

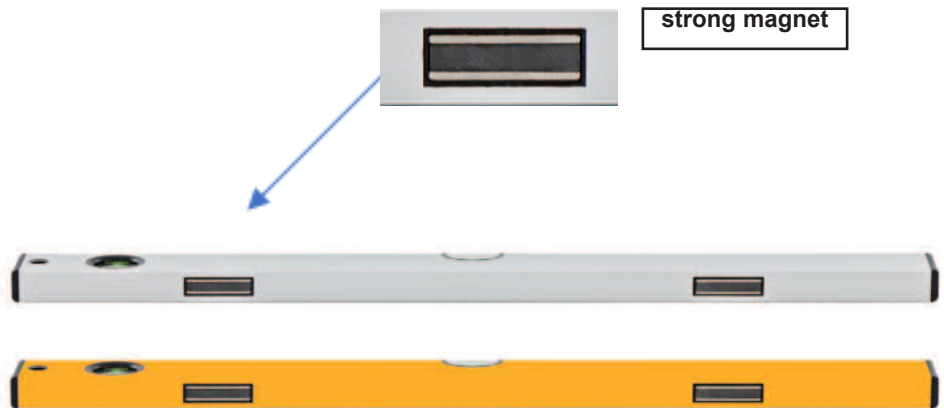

strong magnet

Spirit Levels

Strong aluminium box section, 22/50 mm, sharp-edged, extruded, heat cured, with torsional stiffness, usable as a drawing aid on all sides



SOFT EDGES

NIVEAU SOFT Type 92

strato-silver anodized
1 horizontal vial,
1 vertical vial

NIVEAU SOFT Type 82

powder-coated in signal colour
1 horizontal vial,
1 vertical vial

NIVEAU SOFT Type 92M

strato-silver anodized
1 horizontal vial,
1 vertical vial
with strong magnets

NIVEAU SOFT Type 82M

powder-coated in signal colour
1 horizontal vial,
1 vertical vial
with strong magnets

Art. No.	length (cm)
92030	30
92040	40
92050	50
92060	60
92070	70
92080	80
92090	90
92100	100
92120	120

Art. No.	length (cm)
82030	30
82040	40
82050	50
82060	60
82070	70
82080	80
82090	90
82100	100
82120	120

Art. No.	length (cm)
92030M	30
92040M	40
92050M	50
92060M	60
92070M	70
92080M	80
92090M	90
92100M	100
92120M	120

Art. No.	length (cm)
82030M	30
82040M	40
82050M	50
82060M	60
82070M	70
82080M	80
82090M	90
82100M	100
82120M	120

available at a surcharge:
3rd vial 90°
3rd vial 45°
alternatively
horizontal vial with 2 additional rings
for setting out 2% slopes

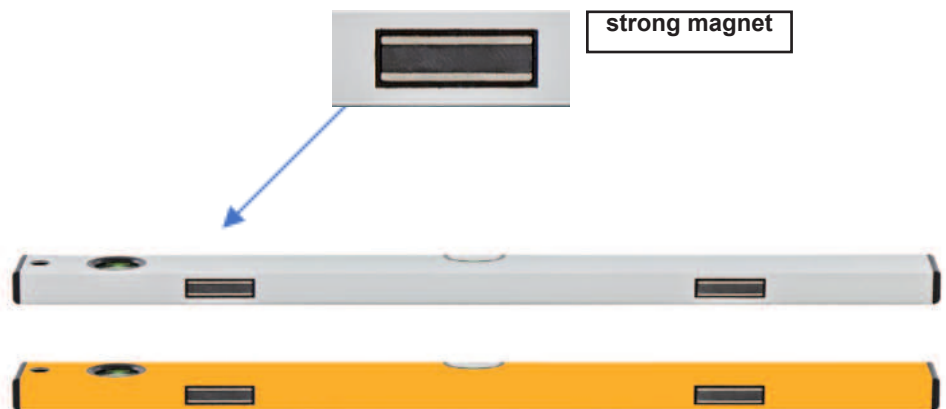



Spirit Levels & Measuring Tapes

Extra strong aluminium box section, 23/50 mm, sharp-edged, extruded, heat cured, with high torsional stiffness, and usable as a drawing aid on all sides



EXTRA STRONG

NIVEAU BIG Type 97

golden anodized
1 horizontal vial,
1 vertical vial

horizontal vial with fluorescent
backing plate allows measuring
in subdued lights

Art. No.	length (cm)
97030	30
97040	40
97050	50
97060	60
97070	70
97080	80
97090	90
97100	100
97120	120
97150	150
97180	180
97200	200

KISTENMACHER brand pocket-sized measuring tapes are the ideal solution for everyday tasks in manufacturing, construction and at home.

The heavy-duty ABS case is ergonomically shaped for easy handling and equipped with a carrying strap as well as a belt clip.



Art. No.	length (cm)	width	pcs / box
EGK TMB1-2/13	2,0 m / 6 ft.	13 mm	120 pcs.
EGK TMB1-3/13	3,0 m / 10 ft.	13 mm	120 pcs.
EGK TMB1-3/19	3,0 m / 10 ft.	19 mm	120 pcs.
EGK TMB1-3.6/13	3,6 m / 12 ft.	13 mm	72 pcs.
EGK TMB1-3.6/19	3,6 m / 12 ft.	19 mm	72 pcs.
EGK TMB1-5/19	5,0 m / 16 ft.	19 mm	72 pcs.
EGK TMB1-5/25	5,0 m / 16 ft.	25 mm	72 pcs.
EGK TMB1-5/28	5,0 m / 16 ft.	28 mm	72 pcs.
EGK TMB1-5.5/19	5,5 m / 18 ft.	19 mm	72 pcs.
EGK TMB1-5.5/25	5,5 m / 18 ft.	25 mm	72 pcs.
EGK TMB1-5.5/28	5,5 m / 18 ft.	28 mm	72 pcs.
EGK TMB1-6.5/25	6,5 m / 21 ft.	25 mm	48 pcs.
EGK TMB1-7.5/25	7,5 m / 25 ft.	25 mm	48 pcs.
EGK TMB1-8/25	8,0 m / 27 ft.	25 mm	48 pcs.
EGK TMB1-9/25	9,0 m / 30 ft.	25 mm	48 pcs.
EGK TMB1-9/28	9,0 m / 30 ft.	28 mm	48 pcs.
EGK TMB1-10/25	10,0 m / 33 ft.	25 mm	48 pcs.

Measuring Tapes

All Measuring Tapes: width: 13 mm: with 2 measures start „C“ (Standard)

optional measurement commencements:

Massanfang A



A: Measurement commencement approx. 10 cm after end fitting

Massanfang B

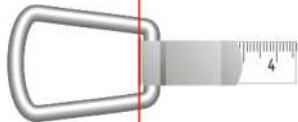

B: Measurement commencement at front fitting edge

Massanfang C

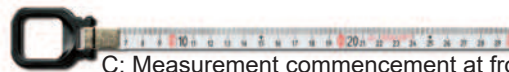

C: Measurement commencement at front ring edge

WEISS brand Measuring Tapes

in steel case with artificial leather coating, metal axle at the crank lever's core ensures long term use



Fibreglass white

Art. No. cm/inch	Art. No. mm/inch	length (m)
287 GL/5	287 GLM/5	5
287 GL/10	287 GLM/10	10
287 GL/15	287 GLM/15	15
287 GL/20	287 GLM/20	20
287 GL/25	287 GLM/25	25
287 GL/30	287 GLM/30	30

Steel white enamelled

Art. No. cm/inch	Art. No. mm/inch	length (m)
208 WE/5	208 WEM/5	5
208 WE/10	208 WEM/10	10
208 WE/15	208 WEM/15	15
208 WE/20	208 WEM/20	20
208 WE/25	208 WEM/25	25
208 WE/30	208 WEM/30	30

Steel yellow enamelled

Art. No. cm/inch	Art. No. mm/inch	length (m)
287 GE/5	287 GEM/5	5
287 GE/10	287 GEM/10	10
287 GE/15	287 GEM/15	15
287 GE/20	287 GEM/20	20
287 GE/25	287 GEM/25	25
287 GE/30	287 GEM/30	30

Plumb Bobs

BOB No. 1

brass, cylindrical, flattened on two sides, 70 mm long, Ø 25 mm, graduations: mm/-, mm/mm, mm/inch, weight 240 g

BOB No. 2

brass, cylindrical, 120 mm long, Ø 20 mm, without graduation, weight 260 g

BOB No. 3

brass, cylindrical, flattened on two sides, 170 mm long, Ø 25 mm, graduation: mm/-, mm/mm, mm/inch, weight 470 g



Nr.1



Nr.2



Nr.3

Measuring Tapes

WEISS brand Measuring Tapes - TYPE 600 angular

white enamelled steeltape, with black plastic handle and steel nickel plated crank, on anodized aluminium frame, graduation cm/inch

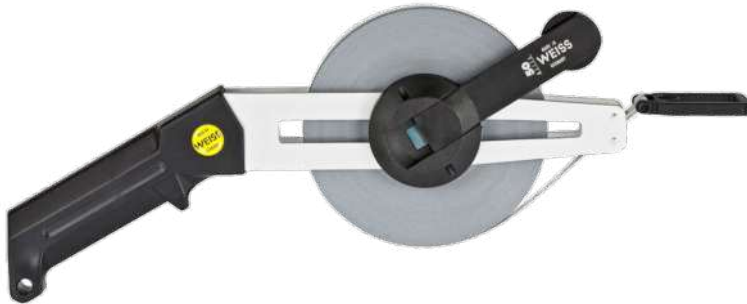

Art. No. cm/inch	length (m)
621 WE/15	15
621 WE/20	20
621 WE/25	25
621 WE/30	30
621 WE/40	40
621 WE/50	50

WEISS brand Measuring Tapes - TYPE 700 - straight

white enamelled steel tape, with black plastic handle and steel nickel plated crank, on anodized aluminium frame, graduation cm/inch

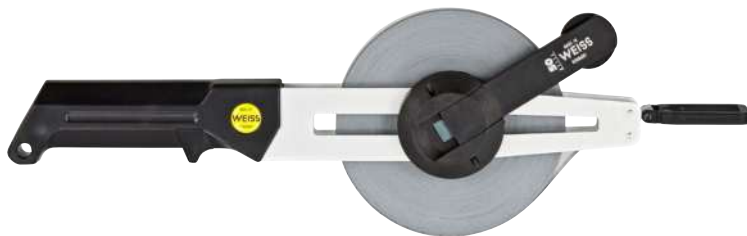

Art. No. cm/inch	length (m)
721 WE/15	15
721 WE/20	20
721 WE/25	25
721 WE/30	30
721 WE/40	40
721 WE/50	50

WEISS brand Measuring Tapes - TYPE 800 straight

white enamelled steel tape, with black plastic handle and steel nickel plated crank, on anodized aluminium triangle frame, graduation cm/inch



Art. No. cm/inch	length (m)
821 WE/20	20
821 WE/25	25
821 WE/30	30
821 WE/40	40
821 WE/50	50
821 WE/100	100

WEISS brand Measuring Tapes - TYPE 900 angular

white enamelled steel tape, with black plastic handle and steel nickel plated crank, on anodized aluminium triangle frame, graduation cm/inch

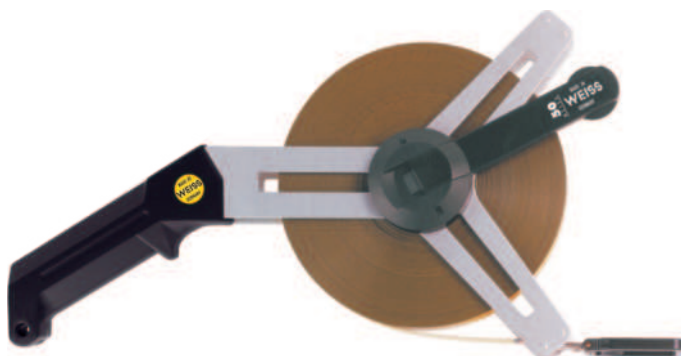

Art. No. cm/inch	length (m)
921 WE/20	20
921 WE/25	25
921 WE/30	30
921 WE/40	40
921 WE/50	50
921 WE/100	100

Measuring Tapes

All Measuring Tapes: width: 13 mm: with 2 measures start „L“ (bob connection)

Weight 11

brass, cylindrical, no graduation, length 190 mm, Ø 24 mm, weight 500 g (can be removed from the tape)

Art. No.

340 00 11



Weight 10

brass, cylindrical, engraved mm scale on one side and inch scale on other side, length 89 mm, dia. 24 mm, weight 300 g (can be removed from the tape)

Art. No.

340 02 10

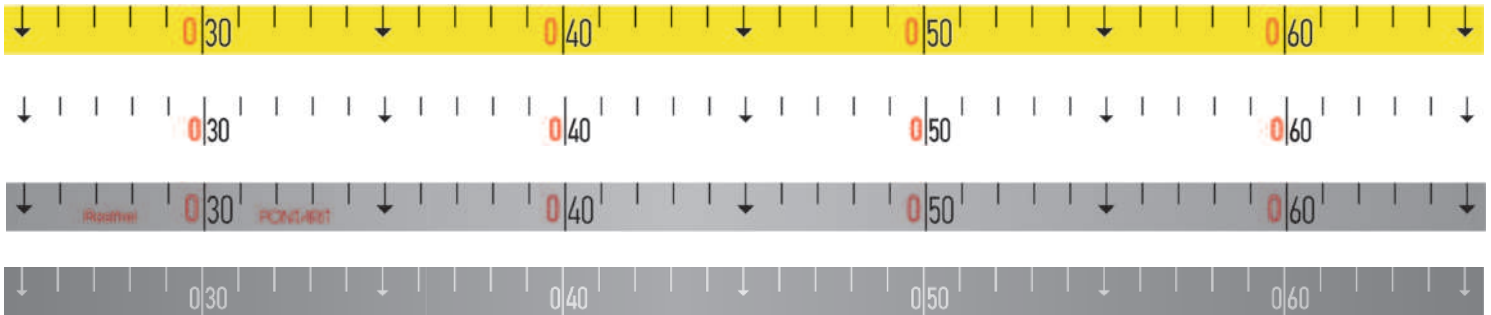

BMI brand Measuring Tapes - straight

13 mm, with black plastic handle and steel nickel plated crank, on anodized aluminium triangle frame

available in

- Fibreglass yellow
- Steel white enamelled
- High etched Carbon Steel black
- High etched Stainless Steel enamelled



Fibreglass yellow

Art. No. cm/inch	Art. No. mm/inch	length (m)
505213010A	505215010A	10
505213015A	505215015A	15
505213020A	505215020A	20
505213025A	505215025A	25
505213030A	505215030A	30
505213050A	505215050A	50

Steel white enamelled

Art. No. cm/inch	Art. No. mm/inch	length (m)
501213010A	501215010A	10
501213015A	501215015A	15
501213020A	501215020A	20
501223025A	501225025A	25
501223030A	501225030A	30
501233050A	501235050A	50

High etched Carbon Steel black

Art. No. cm/inch	Art. No. mm/inch	length (m)
511313010A	511315010A	10
511313015A	511315015A	15
511313020A	511315020A	20
511313025A	511315025A	25
511313030A	511315030A	30
511313050A	511325050A	50

High etched Stainless Steel enamelled

Art. No. cm/inch	Art. No. mm/inch	length (m)
509213010A	509215010A	10
509213015A	509215015A	15
509213020A	509215020A	20
509223025A	509225025A	25
509223030A	509225030A	30
509233050A	509235050A	50



Measuring Tapes

BMI brand Measuring Tapes

white enamelled, on anodized aluminium frame,
with black plastic handle



Art. No. cm/inch	Art. No. mm/inch	length (m)
501013010C	501015010C	10
501013015C	501015015C	15
501013020C	501015020C	20
501013025C	501015025C	25
501013030C	501015030C	30
501013050C	501015050C	50

BMI brand Measuring Tapes

white enamelled, on anodized aluminium frame,
with black plastic handle



Art. No. cm/inch	Art. No. mm/inch	length (m)
501033050C	501035050C	50
501043100C	501045100C	100

BMI brand Measuring Tapes

RADIUS case series

ergonomically shaped case with large crank arm
and park position for commencement ring. Slide bearing shells
for highest winding comfort. with easy grip soft-touch surface.

Fibreglass yellow

Art. No. mm/inch	length (m)
520215010A or C	10
520215015A or C	15
520215020A or C	20
520215025A or C	25
520215030A or C	30
520215050A or C	50

Steel white enamelled

Art. No. mm/inch	length (m)
501215010A or C	10
501215015A or C	15
501215020A or C	20
501225025A or C	25
501225030A or C	30
501235050A or C	50



Special Spirit Levels & Plastic Spirit Levels



ULTRASONIC

- length 25 cm
- vertical headvial
- turnable anglevial
- 2 % slope marking in the horizontal vial
- magnetic
- accuracy 0.5 mm/m

Art. No.

692 025 TWM

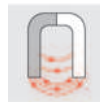

- length 20 cm
- vertical headvial
- horizontal vial with magnifying effect
- magnetic
- accuracy 0.5 mm/m also for inverted measurement

Art. No.

692 020 M

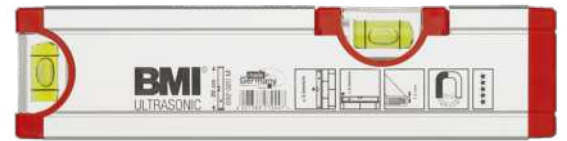
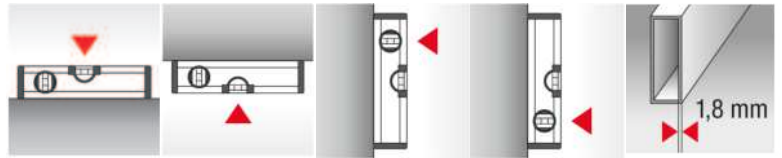

Torpedo-Spirit Level

- length 25 cm
- Alu die-cast model
- milled surface
- magnetic
- accuracy 0.5 mm/m



Art. No.

689 025 TM

Line-Level

- line level made of ABS with clip
- eyelet to hook on to a levelling line
- plexiglass vials

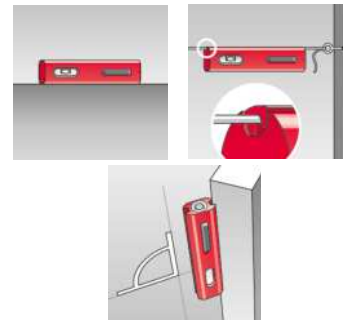

TORPEDO

sturdy spirit levels made of reinforced fibre glass ABS-plastic, round vials allows good readability, magnet execution (685M) equipped with two strong disc magnets.

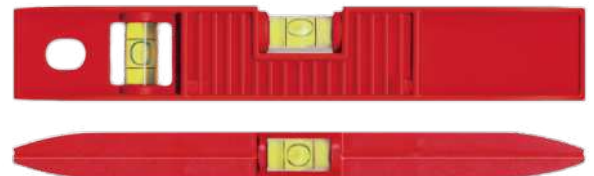

Art. No.	version	dimensions	PU
685 025 002	without magnet	250 x 43 x 002 mm	10
685 025 002 M	with magnet	250 x 43 x 002 mm	10
685 025 003	without magnet +blister packing	250 x 43 x 002 mm	10
685 025 003 M	with magnet + blister pcking	250 x 43 x 002 mm	10



Levelling Instrument (automatic/optic)

Builder's level

automatic self-levelling. Very short minimum target distance. Additional rough sight.



Box
dimensions
270 x 170 x 180 mm

Art. No.	version	magnification	lens opening
646 2024	instrument with box	x 24	36 mm
646 2024 SET	instrument with box, tripod, tenimeter	x 24	36 mm
646 2032	instrument with box	x 32	42 mm
646 2032 SET	instrument with box, tripod, tenimeter	x 32	42 mm

technical data telescope		technical data horizontal circle	
length:	200 mm	diameter	110 mm
shortest target distance	0,9 m	graduation	0 - 400 gon
cm-estimate	150 m	numbering	1 gon
mid km-error	± 2,5 mm		
compensator	magnet		
dimensions	220 x 135 x 135 mm		
weight	1,9 kg		

Measuring Devices

Road Measuring Wheels

handle foldable, capacity: 9.999,99 m, 1cm reading, wheel diameter 318,5 mm = 1 m circumference, subtracts and adds

tolerance below 0,05%, built in stand, integrated brake colour: orange enamelled

Art. No.	version
1200 2001	weight: 3.900 gr - solid full wheel
1200 6001	weight: 3.300 gr - spoke wheel



Road Measuring Wheels

handle foldable, capacity: 9.999,99 m, 1cm reading, wheel diameter 160 mm = 50 cm circumference, subtracts and adds, foldable handle for space-saving transport

tolerance below 0,1%, integrated brake orange powder coated frame

Art. No.	version
1201 4000	weight: 1.300 gr - full disc wheel



Transport Case

artificial leather, for road measuring wheel 1200 2001 + 1200 6001

2 safety locks, strong handle colour: black weight: 2200 g



Art. No.
1290 0000

Transport/Carrying bag

for measuring wheel 1201 4000



Art. No.
1290 3000

Pocket Spring Balances + Vernier Caliper



Pocket Spring Balances „ORIGINAL REBÜRE“

with iron-brassed scale and bright galvanized hook and ring, housing and pointer painted black

Art. No.	range (kg)
102100	0-10.0
102125	0-12.5
102200	0-20.0
102250	0-25.0
102300	0-30.0
102500	0-50.0
1021000	0-100.0



Spring Balances „ORIGINAL REBÜRE“

standard execution, with iron-brassed, round scale and bright galvanized hook and ring, housing and pointer painted black

Art. No.	range (kg)
132010	0-10.0
132025	0-25.0
132050	0-50.0
132100	0-100.0
132150	0-150.0
132200	0-200.0
132300	0-300.0



Vernier Caliper

made of tool steel, scale and nonius satin chrome finished, hardened, 4-way measurements, backside with screw table, in case

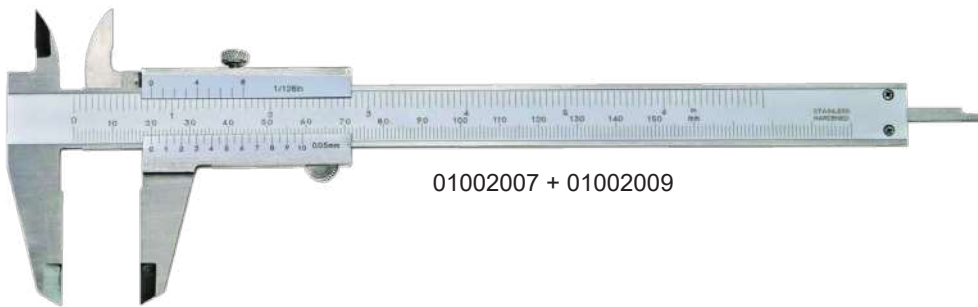

01002007 + 01002009

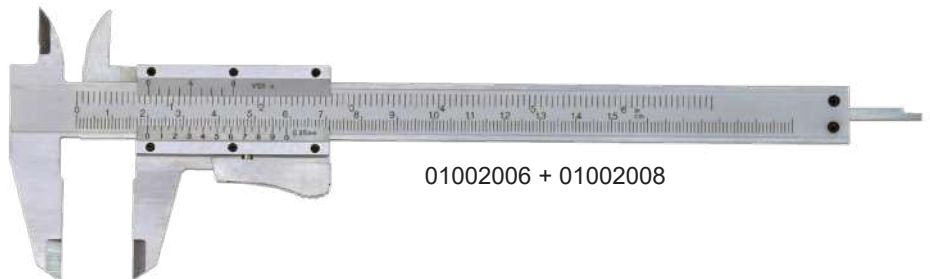

01002006 + 01002008

Art. No.	range (mm)	locking	nonius mm below	nonius inch above	weight (kg)
01002007	150	screw	1/20 - 39	1/128"	0,15
01002009	200	screw	1/20 - 39	1/128"	0,18
01002006	150	auto	1/20 - 39	1/128"	0,15
01002008	200	auto	1/20 - 39	1/128"	0,18

Precision Dividers & Scribes

Precision Spring Divider DIN 6487

with square legs and quick nut
with hardened points

Art. No.	length (mm)
774/100	100
774/125	125
774/150	150
774/175	175
774/200	200
774/250	250
774/300	300
774/400	400
774/500	500
774/600	600



Precision Spring inside Caliper DIN 6487

with square legs and quick nut
with hardened points

Art. No.	length (mm)
776/100	100
776/125	125
776/150	150
776/175	175
776/200	200
776/250	250
776/275	275
776/300	300
776/400	400
776/500	500
776/600	600



Precision Spring outside Caliper DIN 6487

with square legs and quick nut
with hardened points

Art. No.	length (mm)
775/100	100
775/125	125
775/150	150
775/175	175
775/200	200
775/250	250
775/300	300
775/400	400
775/500	500
775/600	600



Wing Divider with joint DIN 6486

with square legs and control arch
with hardened points, made of forged steel

Art. No.	length (mm)
771N/150	150
771N/200	200
771N/250	250
771N/300	300
771N/400	400
771N/500	500
771N/600	600
771N/800	800
771N/1000	1000

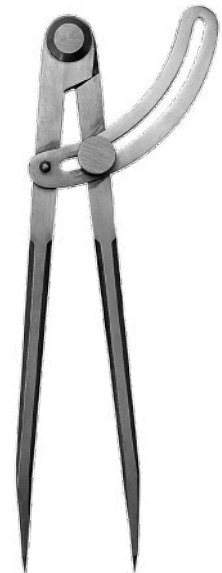

Scriber

with straight and offset hardened steel tips,
exchangeable, chrome-plated
Length: 250 mm, Ø 8 mm
length of straight tip: 100 mm
length of offset tip: 75 mm



Art. No.
257-C

Feeler Gauges

Precision feeler gauges tolerance according to T3 DIN 2275

length of blades 100 mm
conical, width 12,7 mm

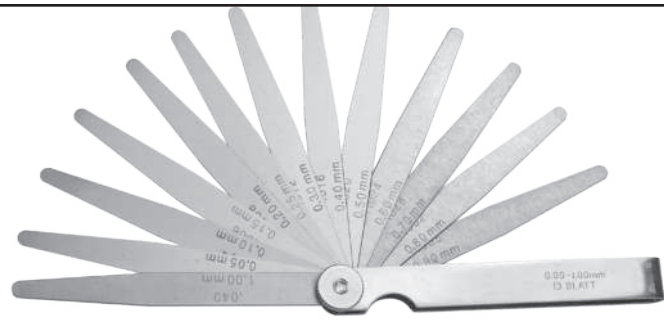

Art. No.	range (mm)	pcs/ set	set combination
6202/3	0.05 - 0,50	8	0,05-0,10-0,15-0,20-0,25-0,30-0,40-0,50
6202/7	0.05 - 1,00	13	0,05-0,10-0,15-0,20-0,25-0,30-0,40-0,50-0,60-0,70-0,80-0,90-1,00
6202/10	0.05 - 1,00	20	0,05-0,10-0,15-0,20-0,25-0,30-0,35-0,40-0,45-0,50-0,55-0,60-0,65-0,70-0,75-0,80-0,85-0,90-0,95-1,00
6202/15	0.03 - 1,00	26	0,03-0,04-0,05-0,06-0,07-0,08-0,09-0,10-0,15-0,20-0,25-0,30-0,35-0,40-0,45-0,50-0,55-0,60-0,65-0,70-0,75-0,80-0,85-0,90-0,95-1,00

Precision feeler gauges on a ring, cylindrical

length of blades 150 - 1000 mm
conical, width 12,7 mm

Art. No. 13 blades	Art. No. 20 blades	length (mm)	range (mm)
08079020	08079030	150	0.05 - 1.00
08079021	08079031	200	0.05 - 1.00
08079022	08079032	300	0.05 - 1.00
08079023	08079033	400	0.05 - 1.00
08079024	08079034	500	0.05 - 1.00
08079025	08079035	600	0.05 - 1.00
08079026	08079036	800	0.05 - 1.00
08079027	08079037	1000	0.05 - 1.00



Double thread calipers

for outside and inside measurements,
whitworth thread: 4-62, metric thread 0.25 - 6.0

Art. No.	blades
6209/6	52
6209/7	58

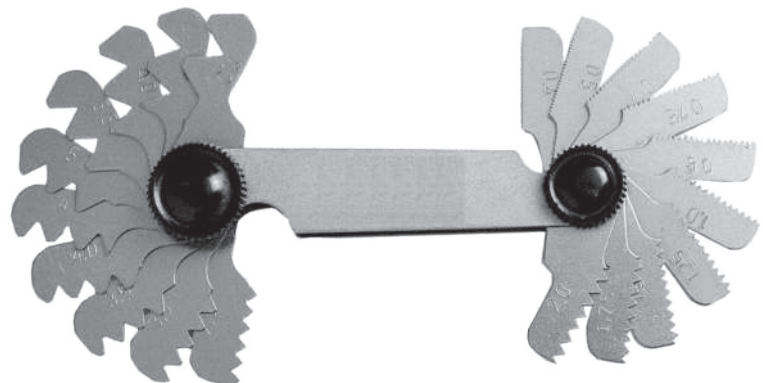

Micrometer + Dial Indicator + Bevel

Outside Micrometer

- with carbide measuring surface
- scale chrome finished
- frame metallic coated
- spindle diameter 6.5 mm
- thread pitch 0.5 mm
- with ratchet
- scale 0.01 mm, accuracy DIN 863
- at 25 - 50 mm with setting standard
- in case



Art. No.	range (mm)
620C/1	0 - 25
620C/2	25 - 50
620C/3	50 - 75
620C/4	75 - 100
620C/5	100 - 125
620C/6	125 - 150

Dial Indicator

range 10 mm, reading 0.01 mm, accuracy according to works standard, metal casing, with tolerance marks, standard stem 8 h6, dial face rotatable by outer ring, in case



Art. No.	range (mm)	reading (mm)	accuracy μm	diameter C (mm)
6080	10	0,01	17	56

Joiner's adjustable sliding bevels with casting shank and thumb screw

with galvanized fixing screw



Art. No.	blade (mm)	handle (mm)	weight (kg)
03047000	200 x 20 x 0,8	22 x 10	0,120
03047001	250 x 20 x 0,8	22 x 10	0,150
03047002	300 x 20 x 0,8	22 x 10	0,160

Protractor + Rulers

Protractor, black aluminium, 0 - 180°

- double graduation 1°
- black aluminium (HRC63)
- scratch resistant
- hard coating
- reading 1° mm
- with fixing screw



Art. No.	of protractor (mm)	rule (mm)
05058030	80	120
05058031	120	150
05058032	150	200
05058033	200	300
05058034	300	500

Stainless steel rulers „CHESTERMAN“

- reading from left to right
- spring stainless steel, graduation etched
- works standard



Art. No.	measurements (mm)	graduation	graduation / type
07074040	150 x 18 x 0,5	single-sided	inch/mm: top 1/64; 1/32 and 1/16 inch graduation, bottom 1/2 mm und 1/1 mm graduation
07074044	300 x 18 x 0,5	single-sided	inch/mm: top 1/64; 1/32 and 1/16 inch graduation, bottom 1/2 mm und 1/1 mm graduation
07074045	500 x 18 x 0,5	single-sided	inch/mm: top 1/64; 1/32 and 1/16 inch graduation, bottom 1/2 mm und 1/1 mm graduation
07074046	1000 x 18 x 0,5	single-sided	inch/mm: top 1/64; 1/32 and 1/16 inch graduation, bottom 1/2 mm und 1/1 mm graduation
07074047	2000 x 30 x 1,0	single-sided	inch/mm: top 1/2 and 1/1 mm graduation, bottom 1/64; 1/32 and 1/16 inch graduation

Rulers, flexible steel, EG class II

- reading from left to right
- spring steel
- stainless, satin chrome finish
- flexible version



Art. No.	range (mm)	profile (mm)	graduation / type	graduation
07074000	100	13 x 0,5	B - 1, 2, 3, 1/2 mm/mm: top 1/2 mm, bottom 1/1 mm graduation	both-sided
07074001	150	13 x 0,5	B - 1, 2, 3, 1/2 mm/mm: top 1/2 mm, bottom 1/1 mm graduation	both-sided
07074002	200	13 x 0,5	B - 1, 2, 3, 1/2 mm/mm: top 1/2 mm, bottom 1/1 mm graduation	both-sided
07074003	250	13 x 0,5	B - 1, 2, 3, 1/2 mm/mm: top 1/2 mm, bottom 1/1 mm graduation	both-sided
07074004	300	13 x 0,5	B - 1, 2, 3, 1/2 mm/mm: top 1/2 mm, bottom 1/1 mm graduation	both-sided
07074005	500	18 x 0,5	B - 1, 2, 3, 1/2 mm/mm: top 1/2 mm, bottom 1/1 mm graduation	both-sided
07074006	1000	18 x 0,5	B - 1, 2, 3, 1/2 mm/mm: top 1/2 mm, bottom 1/1 mm graduation	single-sided
07074008	2000	18 x 0,5	B - 1, 2, 3, 1/2 mm/mm: top 1/2 mm, bottom 1/1 mm graduation	single-sided

Optionally available in profile 30 x 1,00 mm

Industrial Accessories

Piano Hinges

size 32 x 0.6 mm, in lengths of 3500 mm,
100 lengths per case

Art. No.	version
3206 K	iron brass-colour painted (khaki)
3206 K/3480	iron brass-colour painted (khaki) lengths of 3480 mm
3206 M	iron brass plated
3206 N	nickel plated
3206 S	stainless steel



Slotted U-Rails

size: 6 x 16 x 0.6 x 3500 mm,
distance of holes 98 mm
100 pcs. per carton



Art. No.	version
11059	brassed
11058	nickel plated

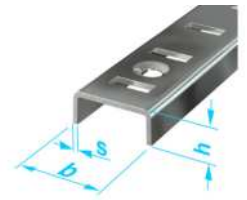

Brackets, 16 mm for slotted U-Rails

300 pcs. per carton

Art. No.	version
11034	brassed
11033	nickel plated



Lead Sheets

made of Pb99,94 Cu, acc. to DIN 59610 EN 12588,
packed in rolls of 50 kg, each 20 rolls on a pallet,
wrapped with shrinkfoil, width 1000 mm

Art. No.	size (mm)	length (mm)
12.050	1.0	4400
12.062	1.5	2900
12.065	2.0	2200
12.068	2.5	1750
12.070	3.0	1500



Threaded Rods

grad 4,8, zinc plated, DIN 975
raw material: mild steel grade Q195/Q235,
packed in bundles of abt. 20 kg

size (mm)	Art. No. 1 m length	Art. No. 2 m length	Art. No. 3 m length	Art. No. 4 m length													
M 6	EGK M06x1MTRS	EGK M06x2MTRS	EGK M06x3MTRS	EGK M06x4MTRS													
M 8	EGK M08x1MTRS	EGK M08x2MTRS	EGK M08x3MTRS	EGK M08x4MTRS													
M 10	EGK M10x1MTRS	EGK M10x2MTRS	EGK M10x3MTRS	EGK M10x4MTRS													
M 12	EGK M12x1MTRS	EGK M12x2MTRS	EGK M12x3MTRS	EGK M12x4MTRS													
M 14	EGK M14x1MTRS	EGK M14x2MTRS	EGK M14x3MTRS	EGK M14x4MTRS													
M 16	EGK M16x1MTRS	EGK M16x2MTRS	EGK M16x3MTRS	EGK M16x4MTRS													
M 18	EGK M18x1MTRS	EGK M18x2MTRS </tr <tr> <td>M 20</td> <td>EGK M20x1MTRS</td> <td>EGK M20x2MTRS</td> <td>EGK M20x3MTRS</td> <td>EGK M20x4MTRS</td> </tr> <tr> <td>M 22</td> <td>EGK M22x1MTRS</td> <td>EGK M22x2MTRS</td> <td>EGK M22x3MTRS</td> <td>EGK M22x4MTRS</td> </tr> <tr> <td>M 24</td> <td>EGK M24x1MTRS</td> <td>EGK M24x2MTRS</td> <td>EGK M24x3MTRS</td> <td>EGK M24x4MTRS</td> </tr>	M 20	EGK M20x1MTRS	EGK M20x2MTRS	EGK M20x3MTRS	EGK M20x4MTRS	M 22	EGK M22x1MTRS	EGK M22x2MTRS	EGK M22x3MTRS	EGK M22x4MTRS	M 24	EGK M24x1MTRS	EGK M24x2MTRS	EGK M24x3MTRS	EGK M24x4MTRS
M 20	EGK M20x1MTRS	EGK M20x2MTRS	EGK M20x3MTRS	EGK M20x4MTRS													
M 22	EGK M22x1MTRS	EGK M22x2MTRS	EGK M22x3MTRS	EGK M22x4MTRS													
M 24	EGK M24x1MTRS	EGK M24x2MTRS	EGK M24x3MTRS	EGK M24x4MTRS													



Spanning and Sealing Machines



GEWA brand Spanning and Sealing Machines

body made of high-grade steel

a) Model SIMPLEX I - incl. 1 knife only

Art. No.	range (inch - mm)
76170 0012	1/2 - 13
76170 0058	5/8 - 16
76170 0034	3/4 - 19



b) Model SIMPLEX II - with 3 knives

Art. No.	range (inch)
76172 0000	1/2 - 5/8 - 3/4

Model FAVORIT 100

- adjustable for 3 band width
- no-seal joint for steel strap
- can be used with all kind of high-quality steel bands
- thickness 0.5 mm, band guiding with ring marking

Art. No.	range (inch)
F100	1/2 - 5/8 - 3/4



Model FAVORIT 2000

- no-seal joint for steel strap
- can be used with all kind of high-quality steel bands
- thickness 0.38/0.60 mm

Art. No.	range (inch - mm)
F2000-13	1/2 - 13
F2000-16	5/8 - 16
F2000-19	3/4 - 19



Fixing Material

Sealing Clips - Coppered Finish

length 25 mm, thickness 0.35/0.50 mm
1000 pcs per box

Art. No.	size (inch/mm)
76175 2512	1/2 - 13
76175 2558	5/8 - 16
76175 2534	3/4 - 19

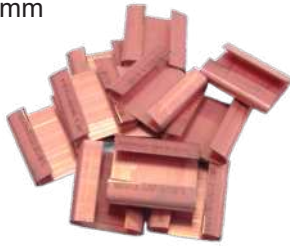

Sealing Clips - Iron Bright Finish

length 25 mm, thickness 0.50 mm
1000 pcs per box

Art. No.	size (inch/mm)
76175 2512B	1/2 - 13
76175 2558B	5/8 - 16
76175 2534B	3/4 - 19



Sealing Clips - Bright Galvanized Finish

size: 32 x 57 x 0.80 mm
200 pcs per box

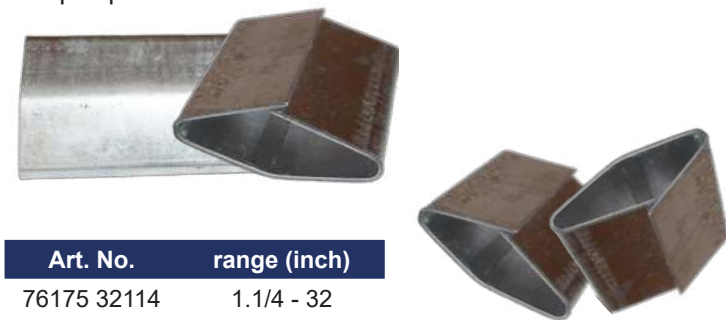

Art. No.	range (inch)
76175 32114	1.1/4 - 32

Steel Straps

bright, cold-rolled,
thickness 0.50 mm
in rings of 15.0 kg
2 rings each bundled

Art. No.	size (inch/mm)
76180 0012	1/2 - 13
76180 0058	5/8 - 16
76180 0034	3/4 - 19



Lead Seals

Pb940R EN 12659

Art. No. bags of 1 kg	dia mm
753080	8
753100	10
753120	12
753140	14
753160	16



Art. No. bags of 1000 pcs	dia mm
751100	10
751120	12

Lead Sealing Pliers

with straight handles
a) polished
b) nickel-plated with blue coated handles



Wire for Lead Seals on Spools

galvanized, size 0.50/0.30 mm

Art. No.	g / spool	meter / spool
1115030-05	250	96
1115030-06	500	193
1115030-07	1000	385



Art. No. polished	Art. No. w/blue handle	length (mm)	punch dia (mm)
25/0000	25/0000 bl	130	8.0
25/000	25/000 bl	150	9.0
25/00	25/00 bl	170	10.0
25/0A	25/0A bl	190	11.0
25/0B	25/0B bl	220	12.0

Revolving Punch Pliers

Revolving Punch Pliers

with additional hole diameter indicator, automatic lock function, exchangeable tubes Ø 2.0 - 4.5 mm, single packed in cardboard boxes, size: 225 mm / 9"



with nickel plated handles

Art. No.

0910-3500(B)



with bright handles
(plain finish)

Art. No.

0910-3501(B)

Revolving Punch Pliers

with additional hole diameter indicator, automatic lock function, exchangeable tubes Ø 2.0 - 4.5 mm, single packed in cardboard boxes, size: 225 mm / 9"

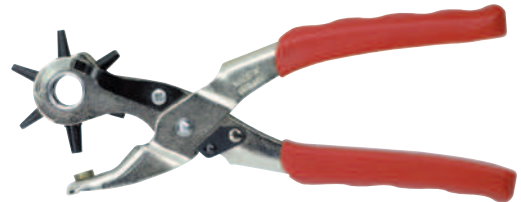

with nickel plated and
red plastic coated handles

Art. No.

0910-3509(B)

Lever Action Revolving Punch Plier

with additional hole diameter indicator, exchangeable tubes Ø 2.0 - 4.5 mm, bright, nickel-plated, with ergonomical shaped red plastic handle, single packed in cardboard boxes, size: 250 mm / 10"

Art. No.

0930-3701(B)



Revolving Punch Plier - Powder Coated

with additional hole diameter indicator, automatic lock function, exchangeable tubes Ø 2.0 - 4.5 mm, single packed in cardboard boxes, size: 225 mm / 9"



Art. No.

0910-3508(B) black, with red plastic handles

Revolving Punch and Eyelet Plier (Two in One)

automatic lock function, bright, nickel-plated, with ergonomical shaped red plastic handles, packed in cardboard boxes, size: 225 mm / 9"



Art. No.

0920-3601(B) with red plastic handles

for eyelets please refer to page 223/224

Garant® S Cable Reel

brennenstuhl®



Top in quality and design, for every requirement and use

- reel body made from rust-resistant and galvanised sheet steel
- with 3-way socket outlet 13 A BS with self-closing cover providing protection against dust and contamination
- ergonomic cable guide handle for perfect cable-management during winding
- with hinged rotary handle for comfortable rolling up
- with thermal cut-out protection against overheating



Art. No.	1198063	1198053	1198113
Socket outlets	3	3	3
Cable length	50 m	25 m	20 m
Cable designation	H05VV-F3G1.5	H05VV-F3G1.5	H05VV-F3G2.5
Packing Unit	1	1	1
Cable Colour	black	black	black
Reel diameter	290 mm	240 mm	240 mm



Top in quality and design, for every requirement and use

- reel body made from rust-resistant and galvanised sheet steel fitted to a particularly sturdy galvanised steel tube frame
- ergonomic cable guide handle for perfect cable-management during winding
- with 3-way socket outlet 13 A BS with self-closing cover providing protection against dust and contamination
- with thermal cut-out protection against overheating



Art. No.	1072933
Socket outlets	3
Cable length	15 m
Cable designation	H05VV-F3G1.5
Packing Unit	1
Cable Colour	black
Reel diameter	190 mm





KISTENMACHER

Cable Reel



Top in quality and design, for every requirement and use

- with thermal cut-out protection against overheating.
- reel body made from rust-resistant and galvanised sheet steel
- With 3-way socket outlet 13 A BS with self-closing cover providing protection against dust and contamination
- ergonomic cable guide handle for perfect cable-management during winding



Art. No.
Socket outlets
Cable length
Cable designation
Packing Unit
Cable Colour
Reel diameter

1198067

3

50 m

H05VV-F3G1.5

1

black

290 mm



1198057

3

25 m

H05VV-F3G1.5

1

black

290 mm



fully certified

famous branding

Made in Germany



Cable Reels

Garant® Cable Reel with USB-Charger

- reel body made from special plastic fitted to a galvanised steel tube frame
- 2 earthed sockets, with self-closing covers
- 2 USB-A charging sockets, dust- and dirt-protected
- total charging amperage of max. 2100 mA for quick reload



Art. No.
Cable length
Cable designation
Packing Unit
Cable Colour
Reel diameter

1208063600
50 m
H05VV-F3G1.5
1
black
290 mm

1078183604
15 m
H05VV-F3G1.5
4
black
180 mm



Rubber Cable Reel X-Gum

- compact and robust lightweight with integrated carrying handle
- extremely robust, impact resistant, ageing and weather resistant
- 3 earthed sockets, with self-closing covers
- with thermal cut-out protection against overheating

Compact AK 180 Cable Reel

- with 3-way socket outlet 13 A BS with self-closing cover providing protection against dust and contamination
- galvanized steel tube frame
- with thermal cut-out protection against overheating



Art. No.
Cable length
Cable designation
Packing Unit
Cable Colour
Reel diameter

1169723150
15 m
H05VV-F3G1.5
2
black
275 mm

1078183004
15 m
H05VV-F3G1.5
4
black
180 mm



Garant® Cable Reel

Garant® Cable Reel

- reel body made from special plastic fitted to a galvanised steel tube frame
- with 3-way socket outlet 13 A BS with self-closing cover providing protection against dust and contamination
- ergonomic cable guide handle for perfect cable-management during winding
- with thermal cut-out protection against overheating



Art. No.	1208063	1218053	1208123	1208113
Cable length	50 m	25 m	40 m	20 m
Cable designation	H05VV-F3G1.5	H05VV-F3G1.5	H05VV-F3G2.5	H05VV-F3G2.5
Packing Unit	1	1	1	1
Cable Colour	black	black	black	black
Reel diameter	290 mm	240 mm	290 mm	240 mm



Garant® Bretec® Cable Reel

With the unique Bretec® Anti Cable Twist System for comfortable working

- reel body made from special plastic fitted to a galvanised steel tube frame
- with 3-way socket outlet 13 A BS with self-closing cover providing protection against dust and contamination
- with hinged rotary handle for comfortable rolling up
- with thermal cut-out protection against overheating



Art. No.	1208863	1208853
Cable length	50 m	25 m
Cable designation	H05VV-F3G1.5	H05VV-F3G1.5
Packing Unit	1	1
Cable Colour	red	red
Reel diameter	290 mm	240 mm



Cable Box

- ergonomic design with a functional and practical rewind for easy handling
- with socket outlet 13 A BS with self-closing cover providing protection against dust and contamination
- with thermal cut-out protection against overheating



Comfort-Line



Art. No.
Cable length
Cable designation
Cable colour
Max. current capacity
Packing Unit
Colour

1109223
3 m
H05VV-F3G1.5
black
13 A
4
black/white

1109233
3 m
H05VV-F3G1.5
black
13 A
4
black/blue



Comfort-Line

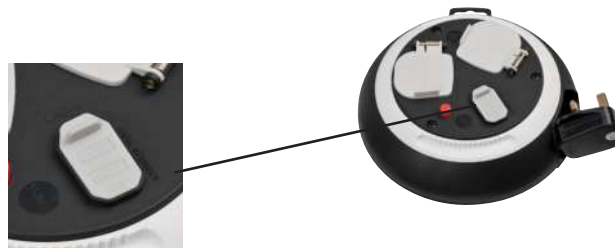

Art. No.
Cable length
Cable designation
Cable colour
USB - Ports
Max. current capacity
Packing Unit
Colour

1109223600
3 m
H05VV-F3G1.5
black
2 x USB - A
13 A
4
black/white



Vario-Line Cable Boxes

- housing made of break-resistant plastic
- easy to wind and rewind
- socket outlet 13 A BS with self-closing cover providing protection against dust and contamination
- with thermal cut-out protection against overheating



Art. No.	1098203	1108563	1093203	1108563600
Cable length	5 m	10 m	10 m	10 m
Cable designation	H05VV-F3G1.5	H05VV-F3G1.5	H05VV-F3G1.5	H05VV-F3G1.5
Cable colour	black	black	black	black
Max. current capacity	13 A	13 A	13 A	13 A
Sockets	3-way	3-way	3-way	2-way
USB-Ports	-	-	-	2 x USB - A
Packing unit	5	5	5	5
Colour	blue/black	blue/black	black/black	blue/black



Art. No.	1108903	1094203	1108553	1108203
Cable length	15 m	15 m	10 m	20 m
Cable designation	H05VV-F3G1.5	H05VV-F3G1.5	H05VV-F3G1.0	H05VV-F3G1.0
Cable colour	black	black	black	black
Max. current capacity	13 A	13 A	10 A	10 A
Packing Unit	5	5	5	5
Colour	blue/black	black	light grey/black	light grey/black



Garant® Cable Reel

brennenstuhl®



Standard AK 260 Cable Reel

- with 3-way socket outlet 13 A BS
- with thermal cut-out protection against overheating



Garant® G Cable Reel

For mobile working with electrical garden tools.



- reel body made from special plastic fitted to a galvanised steel tube frame.
- ergonomic cable guide handle for perfect cable-management during winding.
- with thermal cut-out protection against overheating.



Art. No.
Cable length
Cable designation
Packing Unit
Cable Colour
Plug
Reel diameter

1098253001	1098413001
25 m	50 m
H05VV-F3G1.5	H05VV-F3G1.5
1	1
black	black
BS	BS
260 mm	260 mm

1141743015
25 m
H05VV-F3G1.5
1
blue
BS
240 mm



Garant® RCD Cable Reel

- RCD plug 30mA protects against dangerous electrical accidents.
- reel body made from special plastic on galvanised carrying frame.
- with thermal cut-out protection against overheating.



Standard AK 260 110V CEE 2 Cable Reel

- with twin socket 110 V/16 A - IP 44
- with thermal cut-out protection against overheating



Art. No.
Cable length
Cable designation
Packing Unit
Cable Colour
Plug
Reel diameter

1218753
25 m
H05VV-F3G1.5
1
black
BS
240 mm

1098743	1098783
25 m	50 m
H05VV-F3G1.5	H05VV-F3G1.5
1	1
yellow	yellow
CEE 16A 2P+E(3p) 110V	CEE 16A 2P+E(3p) 110V
260 mm	260 mm





Garant® CEE Cable Reel



Garant® CEE 2 IP 44 Camping/Maritime Cable Reel

For camping and permanent outdoor use, IP44

- reel body made from special plastic fitted to a galvanised steel tube frame
- innovative and ergonomic cable guide handle „cable pilot“ for perfect cable-management during winding. Handle commutes on both sides and allows easy carrying and cable storage. For right and left handed easy to rewind
- cables in signal colour orange, helpful to prevent potential tripping hazards
- CEE plug 230 V/16 A, 2 CEE sockets 230V/16 A
- with single pole safety cut-off and overheating protection

Garant® G CEE 3 IP 44 Camping/Maritime Cable Reel

For camping and permanent outdoor use, IP44

- CEE angle coupling 230 V/16 A including earthing contact combination socket 230 V with self-closing caps + 230 V/16 A CEE plug
- extension cable reel with plug and coupling
- innovative and ergonomic cable guide handle „cable pilot“ for perfect cable-management during winding. Handle commutes on both sides and allows easy carrying and cable storage. For right and left handed easy to rewind
- rotary handle for comfortable rolling up
- reel body made from special plastic fitted to a galvanised steel tube frame
- belt fixation for effortless winding and unwinding of the cable.
- cables in signal colour orange, helpful to prevent potential tripping hazards
- thermal cut-out protection, indicator shows overheating or overloading



Art. No.	1182760100	1182470100
Cable length	25 m	23 m + 2 m
Cable designation	H07RN-F3G2.5	H07RN-F3G2.5
Cable quality	Rubber-Neoprene	Rubber-Neoprene
Cable Colour	orange	orange
Packing Unit	1	1
Reel diameter	290 mm	290 mm
Plug system plug	CEE 16A 2P+E (3p) 230V	CEE 16A 2P+E (3p) 230V

Art. No.	1182760100
Cable length	25 m
Cable designation	H07RN-F3G2.5
Cable quality	Rubber-Neoprene
Cable Colour	orange
Packing Unit	1
Reel diameter	290 mm
Plug system plug	CEE 16A 2P+E (3p) 230V

Art. No.	1182470100
Cable length	23 m + 2 m
Cable designation	H07RN-F3G2.5
Cable quality	Rubber-Neoprene
Cable Colour	orange
Packing Unit	1
Reel diameter	290 mm
Plug system plug	CEE 16A 2P+E (3p) 230V



Garant® CEE Cable Reel



Garant® 110V CEE 2 Cable Reel

Top in quality and design, for every requirement and use

- reel body made from special break-resistant Brefflexx rubber fitted to a galvanized steel tube frame
- With twin socket 110 V/16 A
- ergonomic cable guide handle for perfect cable-management
- with thermal cut-out protection against overheating



Art. No.	1148773	1131953	1138873
Cable length	25 m	25 m	50 m
Cable designation	H05VV-F3G1.5	H05VV-F3G2.5	H05VV-F3G1.5
Packing Unit	1	1	1
Cable Colour	yellow	yellow	yellow
Reel diameter	240 mm	240 mm	290 mm
Plug	CEE 16A 2P+E(3p) 110V	CEE 16A 2P+E(3p) 110V	CEE 16A 2P+E(3p) 110V



Schuko

brennenstuhl®



Garant® Cable Reel S4
with steel body



Art. No.	1195056	1195066
Cable length	25 m	50 m
Reel diameter	240 mm	290 mm

Garant® Cable Reel
with plastic body



Art. No.	1215056	1205066
Cable length	25 m	50 m
Reel diameter	240 mm	290 mm

Compact Cable Reel
with plastic body



Art. No.	1079180004
Cable length	15 m
Reel diameter	180 mm

Art. No.
Cable length
Reel diameter

Vario Line Box
Cable Box for household,
office & DIY. with USB-A port



Art. No.	1093200600
Cable length	10 m

Vario Line box
Cable Box for household,
office & DIY



Art. No.	1092200	1093230
Cable length	5 m	10 m

Comfort-Line Box
Cable Box CL-S for
household, office & DIY



Art. No.	1109220
Cable length	3 m

Art. No.
Cable length

Premium-Line
robust extension socket



Art. No.	1951140100
Cable length	1,8 m
Sockets	4



Art. No.	1951560100
Cable length	3 m
Sockets	6



Art. No.	1955580100
Cable length	3 m
Sockets	8



Art. No.	1391000010
Cable length	3 m
Sockets	10

Art. No.
Cable length
Sockets

Other versions/colours available on request

Lighting Equipment



Safety Inspection Lamps

- the inexpensive quality inspection lamp
- with impact resistant, flexible basket
- with protective glass cover
- supplied with BS plug
- delivery without bulbs

HLP60

HLM60

HLR100

Art. No.	wattage	basket	cable length	cable	plug
HLM60	60	steel	w/o cable		
HLM60/3/BS	60	steel	3 mtr.	H05VV-F2 x 0,75 sqmm	BS
HLM60/5/BS	60	steel	5 mtr.	H05VV-F2 x 0,75 sqmm	BS
HLP60	60	plastic	w/o cable		
HLP60/3/BS	60	plastic	3 mtr.	H05VV-F2 x 0,75 sqmm	BS
HLP60/5/BS	60	plastic	5 mtr.	H05VV-F2 x 0,75 sqmm	BS
HLR100	100	rubber	w/o cable		
HLR100/3/BS	100	rubber	3 mtr.	H05VV-F2 x 0,75 sqmm	BS
HLR100/5/BS	100	rubber	5 mtr.	H05VV-F2 x 0,75 sqmm	BS

LED battery floodlight

Mobile LED battery floodlight with clamping device

The work floodlights with clamping device can be attached anywhere and optimally aligned for the work application thanks to the ball joint

- ideally suited for assembly work, in cellars and on workbenches
- work floodlight with special clamping device for easy mounting by clamping to work surfaces, pipes, panels, etc
- lightweight and robust plastic housing with strong, sturdy clip
- easy alignment of the working light thanks to ball bearing, the angle of inclination of the working light is flexibly adjustable
- With ball joint for individual alignment in all directions by almost 360 degrees
- Integrated USB power bank for charging smartphones etc

3800 LUMEN

IK 08

12 h MAX.

IP 65

USB POWERBANK



1000 LUMEN

IK 08

6 h MAX.

IP 54

USB RECHARGEABLE



LED worklight ideal for a wide range of uses in the trades, at home, in the garden or for camping. Rechargeable LED worklight SH 1000 MA

- design in handy and compact pocket format
- multi-function holding system with carabiner ring and magnet for flexible positioning.
- lightweight and robust
- with on/off switch and 3 different brightness levels (25%/50%/100%) and flash function
- integrated Li-Ion battery 3.7 V/2.2 Ah with charge indicator
- charging via connection type C, charging cable type A/C included (start-up is not possible during charging)

Art. No.	1173070020	1173700005
Luminous flux	3800 lm	1000 lm
Power consumption	40 W	10 W
Colour temperature	6400 K	6500 K
Battery voltage	5 V	3.7 V
Lifetime	54000h	n/a
Battery capacity	5 Ah	2.2 Ah
Battery voltage	7.4 V	3.7 V
Light duration max.	12 h	6 h
Battery charging time about	5 h	3 h
Number of batteries	1	1
Battery type	built-in battery pack	built-in battery pack
Battery technology	lithium-ion	lithium-ion
Impact strength	IK08	IK07
Protection class	III	III
Degree of protection	IP 65	IP 54
Colour	black	black
PU	1	1

Construction Floodlights

Mobile Rechargeable LED Floodlight RUFUS

Highly luminous, versatile and indestructible

- bright light, all the time, even in areas without an electrical connection
- switch with functions - Light: 100 % - 75 % - 50 % - 25 % - 10 %
- USB charging cable A / C
- integrated lithium-ion battery with power bank function and charging indicator
- powerbank function: USB charging port 1 A for devices with USB charging cable such as smartphones, tablets, etc
- casing made of die-cast aluminium, edge protection made of high-quality plastic
- impact-resistant and drop-proof up to 3 m
- stable, multi-stage, folding frame
- with a robust matching bag for safe transport



Art. No.	1173100100	1173110100
Luminous flux	1500 lm	3000 lm
Power consumption	15 W	30 W
Colour temperature	6500 K	6500 K
Battery capacity	5 Ah	5 Ah
Battery voltage	3.7 V	7.4 V
Light duration max.	25 h	25 h
Battery charging time about	3 h	5 h
Number of batteries	1	1
Battery type	built-in battery pack	built-in battery pack
Battery technology	lithium-ion	lithium-ion
Impact strength	IK08	IK08
Protection class	III	III
Degree of protection	IP 65	IP65
Colour	black	black
PU	1	1

**1500
LUMEN**

**3000
LUMEN**



Accessories

Art. No.	1172640002
Description	Magnetic holder for Rechargeable LED spot for Art. No. 1173100100, 1173110100

Hand Lamps

Rechargeable 4 LED Hand Lamp HL DA 40 MH

- 4 super bright SMD LEDs on the front with up to 3 hours of lighting when fully charged
- ON/OFF switch 100/50 %
- base foot with integrated magnet can be folded up to 180°
- belt clip and 360° rotatable hook for flexible use
- USB charging cable included



4 + 3 SMD LED-Universal Lamp HL DB43 MH

- 4 super bright SMD LEDs on the front with more than 6 hours of lighting when batteries are full
- additional switching step for 3 LEDs in the lamp head
- plastic handle with integrated magnet, 360° bendable
- with ON/OFF switch



Rechargeable 4 + 1 LED Clip-on Lamp HL DA 41 MH

- 4 super bright Seoul SMD LEDs on the front with up to 3,5 hours of lighting when fully charged
- charging period approx. 3 hours
- clip with integrated magnet can be rotated 90°
- integrated battery 3.7 V/1.6 Ah with charging indicator
- with ON/OFF switch
- USB charging cable included



LED CLip-On Lamp HL 100

- 5 SMD LEDs on the front with up to 8 hours of light ON time
- additional settings provides another LED in the lamp head
- clip with integrated magnet
- with ON/OFF switch
- USB charging cable included



Art. No.	1176440	1175420010	1175890	1175990010
Lumen	200 lm	200 lm	200 lm	107 lm
2nd source	-	20 lm	150 lm	10 lm
Colour temp.	6500 K	6500 K	6500 K	6500 K
Batt. volt.	3.7 V	1.5 V	3.7 V	1.5 V
Batteries	1	3	1	3
Battery type	built-in battery pack	Micro AAA LR03	built-in battery pack	Micro AAA LR03
Batt. tech.	lithium-ion	alkaline	lithium-ion	alkaline
Colour	black/yellow	black/yellow	black/yellow	black/yellow
PU	1	10	1	10

Hand Lamps

Rechargeable LED Workshop Light WL 500 A

Flexible use with excellent light and ON/OFF switch. Dust protected and splash-proof, IP 54

- ideal for workshop and hobby applications
- 12 super bright Seoul SMD LEDs
- functions: 100 % - 40 % - 10% for long lighting duration
- with ON/OFF switch
- with ergonomic rubber handle
- sturdy, extendable and rotatable hook and magnet in the stand
- impact Li-Ion battery 3.7V/2.2 Ah with charging indicator
- USB charging cable included

Rechargeable LED Hand Lamp SANSA 400 A

Extremely slim lamp for tight spaces

- 12 super bright SMD LEDs at front
- additional switching step for 1 SMD LED in the lamp head
- continuous dimming function 0 to 100 % for particularly long lighting duration
- rubber-clad housing
- bendable and rotatable lamp head, foldable to pocket format
- 2 magnets at the back, one in the holding foot and foot and fold-out hook for flexible use
- integrated Li-Ion battery 3.7 V/2.0 Ah with charging indicator
- USB charging interface, USB charging cable included

520 LUMEN

IP 54

Li-Ion

INCLUSIVE Li-Ion

24 h MAX.

270°



400 +70 LUMEN

Li-Ion

INCLUSIVE Li-Ion

80 h MAX.

270°



Art. No.	1175580	1177370
Luminous flux	520 lm	400 lm / 70 lm
2nd source		
Colour temperature	6500 K	6000 K
Battery capacity	2.2 Ah	2 Ah
Battery voltage	3.7 V	3.7 V
Light duration	24 h	80 h
Battery charging time	5 h	3 h
Number of batteries	1	1
Battery type	built-in battery pack	built-in battery pack
Battery technology	lithium-ion	lithium-ion
Magnets at the back	1	2
Impact strength	IK07	IK07
Protection class	III	III
Degree of protection	IP54	IP20
Colour	black/yellow	black/yellow
PU	1	1

1175580

520 lm

6500 K

2.2 Ah

3.7 V

24 h

5 h

1

built-in battery pack

lithium-ion

1

IK07

III

IP54

black/yellow

1

1177370

400 lm / 70 lm

6000 K

2 Ah

3.7 V

80 h

3 h

1

built-in battery pack

lithium-ion

2

IK07

III

IP20

black/yellow

1

Hand Lamps

brennenstuhl®

Rechargeable LED Hand Lamp

Maximum light output for highest demands

- with super bright COB LED at the front
- additional switching step for 1 SMD LED in the lamp head
- continuous dimming function 10% to 100% for particularly long lighting duration
- rubberised for improved impact resistance and optimal grip
- adjustable up to +/- 60° with integrated magnet
- fold-out hook for flexible use
- USB charging interface, USB charging cable included



Art. No.	1175680	1175640	1175670100
Luminous flux	1000 lm	700 lm	500 lm
Luminous flux secondary source	200 lm	100 lm	120 lm
Colour temperature	6500 K	5700 K	6500 K
Battery capacity	4.4 Ah	2 Ah	2.5 Ah
Battery voltage	3.7 V	3.7 V	3.7 V
Light duration	24 h	10 h	10 h
Battery charging time	3.5 h	3.5 h	4 h
Number of batteries	1	1	1
Battery type	built-in battery pack	built-in battery pack	built-in battery pack
Battery technology	lithium-ion	lithium-ion	lithium-ion
Magnets at the back	2	2	2
Adjustable	up to +/- 60°	up to +/- 90°	-
Impact strength	IK08	IK07	IK07
Protection class	III	III	III
Degree of protection	IP54	IP54	IP20
Colour	anthracite/black	black	black
PU	1	1	6

Hand Lamps

Rechargeable 6 + 1 LED Multi-Function Light HL2 DA 61 M3H2

Multi-purpose, robust with excellent lighting capacity

- 6 super bright SMD LEDs on the front with more than 3 hours of lighting if the battery is fully charged
- additional switching step for 1 SMD LED in the lamp head
- charging time about 4 hours
- rubber-clad housing
- base foot can be folded up to 200° with an integrated magnet
- 2 magnets on the back and two hooks that can be rotated 360° for flexible use
- integrated Li-Ion rechargeable battery 3.7V/2.2 Ah with charging indicator
- USB charging cable included



8 + 1 SMD LED-Universal Lamp HL DB 81 M1H1

Compact, practical for a variety of uses

- 8 super bright SMD LEDs with special lens optics
- more than 4 hours of light when fully charged
- additional switching step for 1 SMD LED in the lamp head
- plastic bracket with integrated magnet can be folded 200°
- 360° hanging hook and magnet facility
- with ON/OFF switch



Rechargeable Hand Lamp LED PL 200 A

- super bright COB LED
- extensive functions: 100 % - 40 % - 10 % - red - red flashing
- with practical clip and magnet in the foot
- USB-C charging cable included



Art. No.	1175670	1175410010	1175590100
Luminous flux	300 lm	250 lm	200 lm
2nd source	100 lm	100 lm	-
Colour temperature	6500 K	6500 K	6500k
Battery voltage	3.7 V	1.5 V	3.7 V
Light duration	10 h	10 h	12 h
Number of batteries	1	3	1
Battery type	built-in battery pack	Mignon AA LR6	built-in battery pack
Battery technology	lithium-ion	alkaline	lithium-polymer
Protection class	III	-	III
Degree of protection	IP20	-	IP20
PU	6	1	10

LED Torches

LuxPremium Focus-LED-Flashlight TL 210 F

Slim and lightweight pen torch with clip

- infinitely variable focus
- Osram LED up to 50.000h lifetime and up to 50m luminous range
- dust protected and splash-proof, IP 44
- versatile use in shirt pocket format
- switching levels: 100% - 40% - 10% - SOS

LuxPremium Focus-LED-Flashlight TL 410 F

- with extra bright CREE-LED for powerful light
- infinitely focus from laminary light to high beam focused light
- switch with soft touch function for 100% - 30% - SOS
- durable aluminium housing with wrist strap

LuxPremium LED-Flashlight THL 300

Multifunctional torch with warning light

- with extremely bright CREE and COB LEDs
- multifunctional switch with 8 operating modes:
 - sequences: Spot at front 100 % - 40 %
 - red - red flashing - off
 - direct control: Spot at front 100 % - floodlight - red flashing
- 180° foldable hook and magnet
- impact-resistant plastic housing and metal head
- with wrist strap



Art. No.	1173750002	1173750004	1178690
Luminous flux	180 lm	350 lm	360 lm
Light duration max.	7 h	34 h	30 h
Colour temperature	6500 K	6900 K	7500 K
Battery voltage	1.5 V	1.5 V	1.5 V
Number of batteries	2	3	3
Battery type	Micro AAA LR03	Micro AAA LR03	Mignon AA LR6
Battery technology	alkaline	alkaline	alkaline
Protection class	III	III	III
Degree of protection	IP44	IP44	IP54
Colour	black	black	black
PU	10	1	1

LED Torches



Rechargeable LuxPremium Focus-LED-Flashlight TL 210 AF

Slim and lightweight pen torch with clip

- infinitely variable focus
- Osram LED up to 50.000h life time and up to 55m luminous range
- dust protected and splash-proof, IP 44
- versatile use in shirt pocket format
- switch levels 100% - 40% - 10% - SOS



Rechargeable LuxPremium LED-Headlight TL 410 A

Compact torch with high luminosity

- CREE-LED up to 50.000h lifetime and up to 131m range
- switch with soft touch function for 100%, 40%, 10% and SOS
- durable aluminium housing with carrying strap
- rechargeable battery (3.7V/2000mAh)
- USB-C charging cable included



Rechargeable LuxPremium Focus-LED-Flashlight TL AF

Extremely bright CREE-LED flashlight with high-quality focus function

- with extra bright CREE LED for powerful light
- infinitely focus from laminary light nearby to high beam focused light
- switch with soft touch function for 100% - 40% - 10% - SOS
- integrated Li-Ion rechargeable battery with charging indicator
- durable aluminium housing with wrist strap
- USB charging included



Art. No.	1173750003	1173750005	1178600401
Luminous flux	200 lm	400 lm	630 lm
Light duration max.	13 h	29 h	22 h
Colour temperature	6800 K	6000 K	6500 K
Battery voltage	3.7 V	3.7 V	3.7 V
Number of batteries	1	1	1
Battery technology	lithium ion	lithium ion	lithium ion
Protection class	III	III	III
Degree of protection	-	IP 44	IP67
Colour	black	black	black
PU	1	1	1

Head Lamps

LuxPremium LED rechargeable Sensor Headlamp SL 400 AF

Multi-functional with very simple operation

- with extremely bright OSRAM LED
- two operating modes: manual and infrared sensor
- infrared sensor for hands-free operation
- headlight 100% - 40% - 10% - SOS - Red
- tail light red, red flashing
- infinitely focus from laminary light nearby to high beam focused light
- exchangeable lithium-ion battery with charging indicator
- focus angle can be adjusted
- USB charging cable included

LuxPremium LED-rechargeable Headlight KL 250AF

Versatile with very long lighting duration

- with extremely bright CREE LED at front with up to 30h lighting duration
- switch with 100% - 50% - 10% - SOS - rear light red/ red flash functions
- infinitely focus from laminary light nearby to high beam focused light
- exchangeable lithium-ion battery with charging indicator
- focus angle can be adjusted
- USB charging cable included

LuxPremium LED-Headlight KL 200 F

Ultra lightweight for more comfort

- with extra bright CREE LED for powerful light
- infinitely focus from laminary light nearby to high beam focused light
- front and rear lights
- switch with 4 different settings (40%, 100%, 100% and red-blinking light at back, SOS).
- focus angle can be adjusted

LuxPremium LED-Headlight KL 100

Ultra lightweight for more comfort

- with extra bright CREE LED for powerful light
- ideal for any application (work, sports, leisure) leaving both hands free
- switch with 3 different settings (100%, 20%, SOS)
- focus angle can be adjusted



Art. No.	1177310	1177300	1178780	1178760
Luminous flux	400 lm	250 lm	200 lm	100 lm
Colour temperature	6500 K	6500 K	6500 K	6500 K
Battery capacity	2.6 Ah	2.6 Ah		
Battery voltage	3.7 V	3.7 V	1.5 V	1.5 V
Light duration max.	50 h	30 h	16 h	35 h
Battery charging time	4 h	4 h		
Number of batteries	1	1	3	3
Battery technology	lithium-ion	lithium-ion	Mignon AA LR6	Mignon AA LR6
Protection class	III	III	III	III
Degree of protection	IP44	IP44	IP44	IP44
Colour	black	black	black	black
PU	1	1	1	10

Hot Air Guns

STEINEL®
HL 1821 S

HL 1620 S

HL 1920 E

- with two heating and airflow stages

- electronically controlled hot air gun with temperature control and cool air stage

Model	HL 1821 S
Art. No. (Schuko-Plug)	068929
Art. No. (BS-Plug)	n. a.
output (watt)	1800
melt. temp. (C°)	300 - 500
voltage	220 - 230
temp. setting	2-stage

Model	HL 1620 S	HL 1920 E
Art. No. (Schuko-Plug)	351106	352103
Art. No. (BS-Plug)	009632	n.a.
output (watt)	1600	2000
melt. temp. (C°)	300 - 500	80 - 600
voltage	220 - 230	220 - 230
temp. setting	2-stage	9-stage

HG 2120 E

- electronically controlled hot air gun with continuously air flow and temperature control

HL 2020 E

- with LCD display
- microprocessor controlled hot air gun with temperature control and cool air stage

HG 2220 E

- manual temperature setting in 9 stages
- including fine dust filter
- easy-to-change power cord
- suitable for push-on nozzles

Model	HG 2120 E
Art. No. (Schuko-Plug)	351403
Art. No. (BS-Plug)	009663
output (watt)	2200
melt. temp. (C°)	80 - 630
voltage	220 - 230
airflow rate	in 3 steps
temp. setting	

Model	HL 2020 E	HG 2220 E
Art. No. (Schuko-Plug)	008192	351700
Art. No. (BS-Plug)	009656	n.a.
output (watt)	2200	2200
melt. temp. (C°)	80 - 630	80 - 630
voltage	220 - 230	220 - 230
airflow rate	in 3 steps	in 2 steps
temp. setting	in 10°C steps	9-stage

Glue Guns



GlueMatic 1007-LT Precise. Handy. 85°C.

- perfect for temperature-sensitive materials, such as polystyrene or film
- fast heating-up time of 8 min.
- flow rate: 4 g/min.
- compact and ergonomic
- integrated, foldable foot for a safe standing position
- suitable for Ø 7 mm **85 °C glue sticks** in different colours
- including 6 glue sticks



GlueMatic 1007-LT

GlueMatic 1007

- ideal for all arts and crafts
- fast heating-up time of 6 min.
- flow rate: 5 g/min.
- compact and ergonomic
- integrated, foldable foot for a safe standing position
- with practical storage box
- suitable for Ø 7 mm glue sticks in different colours
- including 6 glue sticks



GlueMatic 1007

GLUEMATIC 1011

- perfect for everyday craft and repair work
- fast heating-up time of 8 min
- high flow rate of 13 g/min.
- compact and ergonomic
- integrated, foldable foot for a safe standing position
- practical glue stick viewing window
- Suitable for Ø 11 mm glue sticks in different colours
- including 2 glue sticks



GlueMatic 1011

GLUEMATIC 3011

- ideal for challenging bonding projects, floristry or craft activities
- fast heating-up time of 7 min
- high flow rate of 16 g/min.
- interchangeable fine and long nozzle available as an option
- integrated, foldable foot for a safe standing position
- Suitable for Ø 11 mm glue sticks in different colours
- including 3 glue sticks



GlueMatic 3011

MobileGlue 1007

- ideal for fast, cordless arts and crafts, repairs and much more
- lightning-fast heating-up time <15 sec.
- flow rate: 3 g/min.
- eco-mode and charging status display
- suitable for Ø 7 mm glue sticks in different colours
- USB charging cable included
- including 3 glue sticks



MobileGlue 1007

MobileGlue 3011

- ideal for cordless DIY, repairs and professional work
- 100 min. with a single battery charge
- heating-up time: 2 min
- high flow rate of 20 g/min.
- compatible with BOSCH POWER FOR ALL battery system
- two temperature levels for even more bonding applications
- Energy-saving eco-mode
- interchangeable fine and long nozzle available as an option
- with temperature and charging status display
- suitable for Ø 11 mm glue sticks with different melting temperatures



Mobile Glue 3011

GLUE STICKS

Glue Sticks suitable for above models
dia 11 mm, length 250 mm
250 g / pack containing 10 pcs



Art. No.	colour	PU
006761	transparent, ULTRA POWER	10 pcs
006754	transparent, CRYSTAL	10 pcs
006792	black	10 pcs
006808	white	10 pcs
006778	wood application	10 pcs

Glue Sticks Neo

dia 7 mm, length 150 mm
suitable for different materials



Art. No.	colour
006594	transparent, CRYSTAL 240g
000730	transparent, Ultra Power 240g

Voltage Tester

Voltage Testers - EGK VT140 / EGK VT 200

- 100-500 V
- With clip hanger
- In counter-top display box

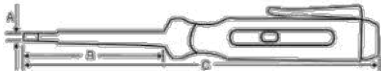

Art. No.

A

B

C

Weight / pc

pcs / Display Box

pcs / Master Carton

pcs / Pallet

EGK VT140

3.5 mm

59 mm

140 mm

21.7 g

20 pcs

500 pcs

12.000 pcs

EGK VT200

4.0 mm

115 mm

200 mm

34.3 g

20 pcs

500 pcs

9.000 pcs

Voltage Testers

- 100-500 V
- with brass cap

EGK 452 PM



EGK 457 PM



Art. No.

Length

pcs / carton

EGK 452 PM/g

140 mm

2.400 pcs

EGK 457 PM/g

190 mm

2.400 pcs

Voltage Testers

Voltage Tester 100 - 500 V

with aluminium cap

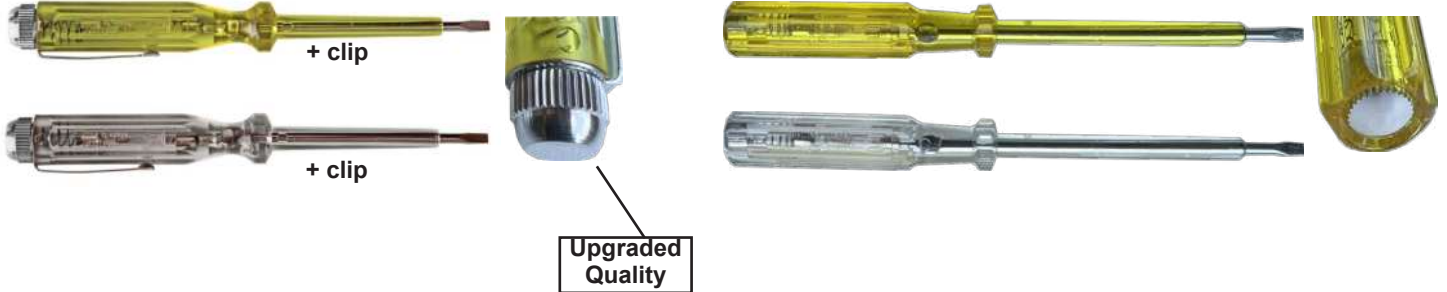

Art. No.	452 PA/k	452 PA/g
Colour	clear	yellow
Length	140 mm	140 mm
pcs / carton	2.400 pcs	2.400 pcs

Art. No.	457 PA/k	457 PA/g
Colour	clear	yellow
Length	190 mm	190 mm
pcs / carton	1.200 pcs	1.200 pcs

Euro Voltage Tester 100 - 500 V

with plastic cap and clip



Art. No.	452 P/K	452 P/G
Colour	clear	yellow
Length	140 mm	140 mm

Euro Voltage Tester 125 - 250 V

with plastic clip



Art. No.	45300P/b	45800P/b	45400P/r	45900P/r	45300P/o	45800P/o
Colour	blue	blue	red	red	orange	orange
Length	150 mm	190 mm	150 mm	190 mm	150 mm	190 mm

Electronic Tester

VT - Volt Check 3.1
IP 61



Art. No.
Range
Display

991895
12-690V AC/DC
LED

VT Master
battery powered, IP 54



Art. No.
Range
Display

991888
12-690V AC/DC
LED

VT Combi Pro
battery powered, IP 65



Art. No.
Range
Display

991886
6-690V AC/DC
LED

VT Digi Pro



Art. No.
Range
Display

991887
1-1000V AC/DC
digital LED

Soldering & Welding



Soldering Irons for Plumbers

with wooden handle

Type No. 1 - Hammer Head



Type No. 4 - Taper Head

Art. No.	weight (g)	Art. No.	weight (g)
1/100	100	1/350	350
1/150	150	1/400	400
1/200	200	1/500	500
1/250	250	1/600	600
1/300	300		

Electric Soldering Irons

with wooden handle

- with 2 core cable and euro plug, 230V, 50/60 cycles

- with 3 core cable and BS-plug 13A, 230-240V, 50/60 cycles



Lightweight model



Heavy duty model



Art. No.	power	Art. No.	power	Art. No.	power
101/2D	60 Watt	121/2D	100 Watt	101/3D BS	60 Watt
120/2D	75 Watt	122/2D	125 Watt	120/3D BS	75 Watt
123/2D	80 Watt	130/2D	150 Watt	121/3D BS	100 Watt
		132/2D	200 Watt	130/3D BS	150 Watt
				132/3D BS	200 Watt

Art. No.	power	Art. No.	power
151/2D	250 Watt	151/3D BS	250 Watt
152/2D	300 Watt	152/3D BS	300 Watt
154/2D	400 Watt	154/3D BS	400 Watt
156/2D	500 Watt	156/3D BS	500 Watt

STANNOL Soldering Irons

with plastic handle, cable length approx. 1,5 m and safety plug (230 V), packed in individual carton



Art. No.	usage	power	tip temp (approx. °C)
750100	for electronics soldering	15 Watt	370
750300	for soldering in radio and telecommunication work	30 Watt	410
750600	for use in electrical installation and work involving fine wires and metal sheets	60 Watt	460
750800	for metal sheets soldering and general workshop operation	80 Watt	480
751000	for coarse soldering work in handicraft	100 Watt	500
751500	for workshop and factory, seam soldering on fine metal sheets	150 Watt	510
752000	for workshop and factory, seam soldering on metal sheets up to 1.0 mm thickness	200 Watt	530

Soldering & Welding



Soldering Set SK 3000

suitable for universal soldering capacity, in practical storage case

contents:

- soldering gun 100W + replacement tip
- soldering iron 30W incl. soldering stand
- de-soldering pump
- soldering aid tool
- solder wire in dispenser tube, 20 g
- helping hand



Art. No.	description
206439	soldering Set SK 3000

STANNOL Soldering Guns

protection class II - double insulated, ready for soldering within 5 sec. (230 V)

Art. No.	power	colour
206430-W90	60 Watt	black colour in blister packing
206460-EP75	75 Watt	blue colour in blister packing
206786-EP100	100 Watt	black colour in blister packing



STANNOL Woodburning Pen 30WBC

with different colours

- power supply 230V
- with soldering iron stand
- 7 woodburning tips: star, windmill, square, triangle, wheel, stripe, dart board
- 6 water colours: white, black, blue, brown, red, yellow + paint brush

Art. No.	power
274006	30 Watt



Sal ammoniac in blocks

for cleaning of soldering tips

Art. No.	description	PU	colour
27100001	Stone No. 1	300 pcs	65 x 45 x 20
27100002	Stone No. 2	150 pcs	65 x 45 x 40
27100004	Stone No. 4	100 pcs	100 x 50 x 25 in plastic jar
27100008	Stone No. 8	200 pcs	100 g in can



Soldering & Welding



Soldering Wire - RA

for soldering onto metals, tins, brass, cans, batteries,
not suitable for soldering involving electrical
engineering and electronic applications



Alloy - S-PB50Sn50 on spools

Ø (mm)	1.0 mm	1.5 mm	2.0 mm	3.0 mm
100 g	18501010	18501510	18502010	18503010
250 g	18501020	18501520	18502020	18503020
500 g	18501030	18501530	18502030	18503030
227 g	18501017	18501517	18502017	18503017
454 g	18501027	18501527	18502027	18503027

Alloy - S-PB60Sn40 on spools

Ø (mm)	1.0 mm	1.5 mm	2.0 mm	3.0 mm
100 g	18401010	18401510	18402010	18403010
250 g	18401020	18401520	18402020	18403020
500 g	18401030	18401530	18402030	18403030
227 g	18401017	18401517	18402017	18403017
454 g	18401027	18401527	18402027	18403027

Alloy - S-PB70Sn30 on spools

Ø (mm)	1.0 mm	1.5 mm	2.0 mm	3.0 mm
100 g	18321010	18321510	18322010	18323010
250 g	18321020	18321520	18322020	18323020
500 g	18321030	18321530	18322030	18323030
227 g	18321017	18321517	18322017	18323017
454 g	18321027	18321527	18322027	18323027

Alloy - S-PB78Sn20 Sb2 on spools (RA 30/70/H4)

Ø (mm)	1.0 mm	1.5 mm	2.0 mm
100 g	1821101092	1821151092	1821201092
250 g	1821102092	1821152092	1821202092
500 g	1821103092	1821153092	1821203092
227 g	1821101792	1821151792	1821201792
454 g	1821102792	1821152792	1821202792

Soldering Wire ISO-Core - SP

Flux-cored soft solder wire acc. to DIN EN ISO 9453
for general soldering of copper and copper base alloys



Alloy - S-PB50Sn50 on spools

Ø (mm)	1.0 mm	1.5 mm	2.0 mm	3.0 mm
100 g	15501010	15501510	15502010	15503010
250 g	15501020	15501520	15502020	15503020
500 g	15501030	15501530	15502030	15503030
227 g	15501017	15501517	15502017	15503017
454 g	15501027	15501527	15502027	15503027

Alloy - S-PB60Sn40 on spools

Ø (mm)	1.0 mm	1.5 mm	2.0 mm	3.0 mm
100 g	15401010	15401510	15402010	15403010
250 g	15401020	15401520	15402020	15403020
500 g	15401030	15401530	15402030	15403030
227 g	15401017	15401517	15402017	15403017
454 g	15401027	15401527	15402027	15403027

Alloy - S-PB70Sn30 on spools

Ø (mm)	1.0 mm	1.5 mm	2.0 mm	3.0 mm
100 g	15321010	15321510	15322010	15323010
250 g	15321020	15321520	15322020	15323020
500 g	15321030	15321530	15322030	15323030
227 g	15321017	15321517	15322017	15323017
454 g	15321027	15321527	15322027	15323027

Alloy - S-PB78Sn20 Sb2 on spools (SP 30/70/H4)

Ø (mm)	1.0 mm	1.5 mm	2.0 mm
100 g	1521101092	1521151092	1521201092
250 g	1521102092	1521152092	1521202092
500 g	1521103092	1521153092	1521203092
227 g	1521101792	1521151792	1521201792
454 g	1521102792	1521152792	1521202792

Soldering & Welding

Soldering Paste (Grease)

flux for general soft soldering to copper and copper base alloys

DIN 29454-1, 3.1.1.C (F-SW 21)



Art. No.	size
243100351	50 g
243100501	100 g
243100551	250 g

Aluminium welding Powder

in PVC-tins

for welding thick aluminium sheets



Art. No.	size
26420050	100 g
26420055	250 g
26420060	500 g
26420070	1000 g

Aluminium welding/soldering Powder „Nr. 1“

DIN EN1045 FL 10

for hard soldering and welding of aluminium and aluminium base alloys



Art. No.	size
26400050	100 g
26400055	250 g
26400060	500 g
26400070	1000 g

Soldering Liquid

flux for general soft soldering to all metallic surfaces except aluminium and stainless steel

DIN 29454-1, 3.1.1.C (F-SW 12)



Art. No.	size
24220051	100 ml
24220056	250 ml
24220061	500 ml
24220071	1000 ml

Hard solder Powder „Universal“

for hard soldering of brass, copper, copper base alloys and steel

DIN EN 1045-FH21



Art. No. Felder	Art. No. Stannol	size
26200050		100 g
26200055	142030	250 g
26200060	142028	500 g
26200070		1000 g

Strengthening powder for hardening of steel

nitrogen-hardening of powder for hardening of iron and unalloyed steel



Art. No.	size
26510060	500 g
26510070	1000 g

Soldering & Welding



Soldering Paste - Silver Solder

fluxing paste for brazing brass - DIN EN 1045 - FH 10



Art. No.	size
26100050	100 g
26100055	250 g
26100060	500 g

Hard Solder Paste

for hard soldering of copper, copper base alloys and steel as well as welding of brass - DIN EN 1045 FH 21



Art. No.	size
26250050	100 g
26250055	250 g
26250060	500 g
26250070	1000 g

Soft Soldering Bars - Triangular

packed in cartons of 25 kgs

Art. No.	description	colour
1215012092	30/70/H3 - Export	L-Pb85Sn15Sb
1221012094	40/60/H4 - Export	L-Pb78Sn20Sb2
1231012095H	50/50H6 - Export	L-Pb70Sn30
12310120	standard quality	S-Pb70Sn30
12410122	standard quality	S-Pb60Sn40
12510120	standard quality	S-Pb50Sn50
1299120	standard quality	L-Sn99,9 (Pure tin)



Brass Welding Rods

in length of 1 mtr., packed in bundles of 10 kg, each bundle packed in plastic foil, 10 bundles per case



	Ø (mm)	2.0	2.5	3.0	3.2	4.0
SMS 60 - L-CuZn40 - hard type		75630 0020	75630 0025	75630 0030	75630 0032	75630 0040
MS 63 - CuZn37 - flexible type		MS 63/2	MS63/2,5	MS63/3	MS63/3.2	MS63/4

Welding Electrodes

**LINCOLN[®]
ELECTRIC**

Cast-Iron Electrodes GRICAST 6

Ni/Cu welding electrodes for welding cast iron, according to AWS A 5.15

Art. No.	size (mm)	weight (kg/box)
99892530	2.5 x 300	3.8
99893235	3.2 x 350	4.5
99894040	4.0 x 400	5.0



Welding Stick Electrodes CONARC 49

for shipbuilding and light general construction work, according to AWS A5.1, E 7018 H44, ISO 2650-A



Art. No.	size (mm)	weight (kg/box)
609266	2.5 x 350	4.5
609267	3.2 x 350	4.5
609268	4.0 x 350	5.0
609270	5.0 x 450	6.7

GRILUMIN 14 Welding Electrodes

for aluminium alloys, used for marine constructions and repairing cast aluminium, bodies and components of pumps, electric motor housings etc., according to AWS A5.3-91 E 4043

Art. No.	size (mm)	weight (kg/tin)
803204	3.2 x 350	2.0



SUPERGLAZE MIG-4043

wire electrodes for aluminium alloys, used for welding of automotive components like frame and drive shafts, bicycle frames according to AWS A5.10/5.10M, ER 4043, ISO 18273

Art. No.	Ø (mm)	weight (kg/spool)
701753	1.0	7.0
701754	1.2	7.0



SUPERGLAZE MIG-5356

wire electrodes for aluminium alloys, used for welding of structural frames in shipbuilding, furniture, storage tanks, railway, automotive and trailer industry according to AWS A5.105.10M, ER 5356, ISO 18273

Art. No.	Ø (mm)	weight (kg/spool)
701762	0.8	7.0
701763	1.0	7.0
701764	1.2	7.0
701765	1.6	7.0



Welding Electrodes

KISTENMACHER Aluminum Welding Sticks

ALUMINIL Si5 Welding Sticks E 4043-aluminium,
EN ISO 18273 - AWS A 5.3
packed in alu cans of 2.0 kg



Art. No.	size (mm)	weight (kg/can)
ALSi5-2,5	2.5 x 350	2.0
ALSi5-3,2	3.2 x 350	2.0

Welding Electrode Rods

HILCO Aluminium AISi5 Welding Electrode Rods ER 4043
EN ISO 18273 - AWS A 5.10
packed in cartons of 5.0 kg



Art. No.	size (mm)	weight (kg/box)
75190	1.6 x 1000	5.0
75191	2.0 x 1000	5.0
75947	2.4 x 1000	5.0
75192	3.2 x 1000	5.0

Nickel Iron Stick Electrodes

HILCO Nickel Iron Stick Electrodes, ENiFe-Ci,
packed in packs of 1.0 kg
EN ISO 1071 AWS-standards A5.15



Art. No.	Ø (mm)	weight (kg/box)
70403	3.2 x 350	1.0

Welding Electrode Rods

HILCO AL Mg5 Welding Electrode Sticks ER 5356
EN ISO 18273: S Al 5356 (AlMg5Cr(A)) - AWS A 5.10
packed in cartons of 5.0 kg



Art. No.	Ø (mm)	weight (kg/box)
78218	1.6 x 1000	5.0
77940	2.0 x 1000	5.0
77019	2.4 x 1000	5.0
66658	3.2 x 1000	5.0

Welding Stick Electrodes HILCO BASIC

for shipbuilding and light general construction work,
E 7018-1

Art. No.	size (mm)	weight (kg/box)
61818	3.2 x 350	5.8
61819	4.0 x 450	4.3



Safety Equipment

Welding Goggles

traditional welding goggles with a flip up mechanism for the shaded welding glasses, indirect ventilation as well as easy replacement of lenses with screw-on construction. With adjustable headband for comfortable fit.



Art. No.	shade	colour	lens size
172200105	5	yellow	50 mm

Safety Welding Goggles Model 879

Art. No.	shade	colour	lens size
187902740	clear	black	50 mm
187902106	6	black	50 mm
187902105	5	black	50 mm



Dark Welding Glasses DIN 4646/4647

available sizes:
50 x 105 mm
50 x 108 mm
51 x 108 mm

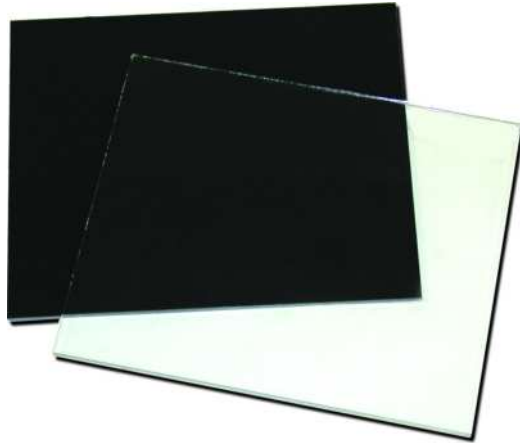

Art. No.	shade
50105/9	9
50105/10	10
50105/11	11
50105/12	12

Art. No.	shade
51108/9	9
51108/10	10
51108/11	11
51108/12	12

Art. No.	shade
50108/9	9
50108/10	10
50108/11	11
50108/12	12



Heavy Duty Electrode Holders

with pressure spring, brass version, 60 % duty cycles

Art. No.	amp	sqmm
512.D255	200	25/35
512.D256	300	35/50
512.D257	400	50/70
512.D258	500	70/95
512.D259	600	70/95



Welding Electrode Holders

- export version - fully insulated, black

Art. No.	amp
3102-300	300
3102-400	400
3107-500	500
3107-600	600



Earth Clamps for Welders

with cable-shoe connection

Art. No.	amp
4165	300
4166	400
4167	600



Welding cable connectors

EN 60974-12

Art. No.	Art. No.	size (sqmm)
male-plug	female-socket	
511.0005	511.0003	10-25
511.0015	511.0013	35-50
511.0031	511.0029	50-70
511.0042	511.0000	70-95



Safety Equipment

Protective Hand-Shields Type EURO-STAR

thermostable up to 100° C - straight, made of black ABS material, with lens frame and handle

Art. No.	Glass size	version
214001	90 x 110 mm	with lens DIN9
214000	90 x 110 mm	w/o lens



Protective Hand-Shields Type EURO-HANDY 2000

thermostable up to 120° C - inclined

Art. No.	Glass size	version
200101	90 x 110 mm	with lens DIN 9
200100	90 x 110 mm	w/o lens



Welding Helmets Type EURO, working temperature up to 100°C

a) made of black ABS material

Art. No.	Glass size	version
219401	90 x 110 mm	with lens DIN9
219400	90 x 110 mm	w/o lens



Welding Helmets Type EURO, working temperature up to 140°C

b) fibre-glass reinforced

Art. No.	Glass size	version
219410	90 x 110 mm	with lens DIN9
219411	90 x 110 mm	w/o lens



Ear Protection

Ear defenders with fixed headband and adjustable ear muffs.

According to EN 352

Art. No.

2400000



Marking Crayons, Hose Clips & Fixing Material

BLEISPITZ brand Marking Crayons hexagonal

size: 12 x 120 mm
1 dozen in a carton box



Art. No.	colour
0136	red
0143	blue
0150	yellow
0167	white
0174	black
0181	green

LYRA brand Marking Crayons

size: 11 x 110 mm
1 dozen in a carton box



Art. No.	colour
L4850001	white
L4850007	yellow
L4850017	red
L4850051	blue
L4850067	green
L4850099	black

NORMA brand Hose Clips TORRO

in carton box packing



range mm	Art. No. width 12 mm
16-27	W1/16-27/12
20-32	W1/20-32/12
25-40	W1/25-40/12
30-45	W1/30-45/12
35-50	W1/35-50/12
40-60	W1/40-60/12
50-70	W1/50-70/12
60-80	W1/60-80/12
70-90	W1/70-90/12
80-100	W1/80-100/12
90-110	W1/90-110/12
100-120	W1/100-120/12
110-130	W1/110-130/12
120-140	W1/120-140/12
130-150	W1/130-150/12
140-160	W1/140-160/12
150-170	W1/150-170/12
160-180	W1/160-180/12
180-200	W1/180-200/12
200-220	W1/200-220/12

range mm	Art. No. width 9 mm
8-12	W1/8-12
10-16	W1/10-16
12-18	W1/12-18
12-22	W1/12-22
16-27	W1/16-27
20-32	W1/20-32
25-40	W1/25-40
30-45	W1/30-45
35-50	W1/35-50
40-60	W1/40-60
50-70	W1/50-70
60-80	W1/60-80
70-90	W1/70-90
80-100	W1/80-100
90-110	W1/90-110

Steel Collars for Light Pipes

band size 15 x 1.2 mm,
thread M6, bulk packing 100 pcs

Art. No.	pipes for mm	type
1402	14	CT14
1403	16	CT16
1404	18	CT18
1405	20	CT20
1406	22	CT22
1407	24	CT24
1408	26	CT26
1409	28	CT28



Steel Collars

screw with threaded steel, with
wall plug, blister packing



4 + 4 + 4 pcs / pack

Art. No.	pipes for mm	type
3191	14	CTV14.S
3192	16	CTV16.S
3193	18	CTV18.S
3194	20	CTV20.S
3195	22	CTV22.S
3196	24	CTV24.S

3 + 3 + 3 pcs / pack

Art. No.	pipes for mm	type
3197	26	CTV26.S
3198	28	CTV28.S



Fixing Materials

Fixing Sets

in poly bag packing



for Water Boilers

Art. No.	size (mm)	packing unit
5771 00 1095 1	10 x 950	100 pcs

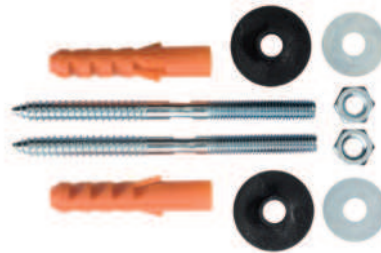

for Wash Basin

Art. No.	size (mm)	packing unit
5772 10 0140 1	10 x 140	80 pcs

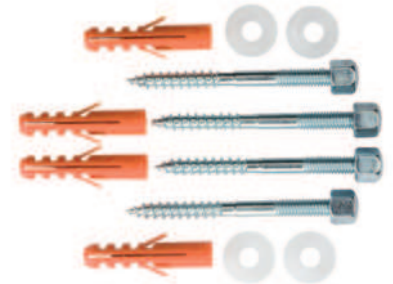

for WC and Bidet

Art. No.	size (mm)
5773 04 6070 1	6 x 70
5773 04 6090 1	6 x 90

Mirror Clamps Sets

4-piece, with 2 upper parts and 2 lower parts and 4 screws, 250 pcs per set

steel nickel-plated, in poly bag packing
Art. No. 6503 GE 0000 2

stainless steel, with additional 4 wall plugs, in carton packing
Art. No. 6503 SS 0000 2



VITOMOUNT Mirror Tapes

temperature up to 70°C

colour: white, two side-adhesive,
in rolls of 66 m,
13 pcs per carton

thickness 1 mm, covered with
green silicon-foil, 25 x 1 mm

Art. No.

125-SS-70 PE

thickness 1 mm, covered
with brown silicon-paper,
25 x 1 mm

Art. No.

125-SS-70 PBR



wood Screws

with inner thread 1/8" specially
made for mirror caps, iron
galvanized, Ø 4.5 mm



Art. No.	length (mm)
357/20	20
357/25	25
357/30	30
357/35	35
357/40	40
357/50	50
357/60	60

Mirror Caps

with 1/8" threaded pin

pointed



rounded



Art. No.	Ø (mm)
348/12	12
348/16	16
348/19	19
348/24	24

Art. No.	Ø (mm)
349/10	10
349/13	13
349/15	15
349/18	18
349/24	24

Fixing Materials



KISTENMACHER brand Assortment Boxes (300 pcs per box)

several assortments of wall plugs, pan head and countersunk screws.

a) Countersunk PZ

Art. No. 28568-A/EGK

containing screws:

- 60 pcs 3.5 x 30 mm
- 60 pcs 4.5 x 40 mm
- 30 pcs 6.0 x 50 mm

containing wallplugs:

- 60 pcs 5 x 25 mm
- 60 pcs 6 x 30 mm
- 30 pcs 8 x 40 mm

b) Pan Head PZ

Art. No. 28568-B/EGK

containing screws:

- 60 pcs 3.5 x 30 mm
- 60 pcs 4.5 x 40 mm
- 30 pcs 6.0 x 50 mm

containing wallplugs:

- 60 pcs 5 x 25 mm
- 60 pcs 6 x 30 mm
- 30 pcs 8 x 40 mm

c) MIX 50/50 PZ

Art. No. 28568-C/EGK

containing countersunks PZ:

- 30 pcs 3.5 x 30 mm
- 30 pcs 4.5 x 40 mm
- 15 pcs 6.0 x 50 mm

containing pan head screws:

- 30 pcs 3.5 x 30 mm
- 30 pcs 4.5 x 40 mm
- 15 pcs 6.0 x 50 mm

containing wallplugs:

- 60 pcs 5 x 25 mm
- 60 pcs 6 x 30 mm
- 30 pcs 8 x 40 mm

d) Wall Plugs only

Art. No. 28568-D/EGK

containing:

- 100 pcs 5 x 25 mm
- 150 pcs 6 x 30 mm
- 50 pcs 8 x 40 mm



KISTENMACHER brand

Sets of Anchors and Screws



Art. No.	type	screw	size (mm)	PU / SET
280420/EGK	PZ 1	countersunk	4.0 x 20	25
280525/EGK	PZ 2	countersunk	5.0 x 25	20
280630/EGK	PZ 2	countersunk	6.0 x 30	12
280840/EGK	PZ 3	countersunk	8.0 x 40	8
2820420/EGK	PZ 1	pan head	4.0 x 20	25
2820525/EGK	PZ 2	pan head	5.0 x 25	20
2820630/EGK	PZ 2	pan head	6.0 x 30	12
2820840/EGK	PZ 3	pan head	8.0 x 40	8
281050/EGK	HEX	pan head	10.0 x 50	4
281260/EGK	HEX	pan head	12.0 x 60	2



Fixing Materials

Expandet brand Wall Plug

for fixing in solid brick and concrete in carton packing



Art. No.	size (mm)	length (mm)	colour
120425	4.0	25	yellow
120525	5.0	25	white
120535	5.0	35	white
120625	6.0	25	red
120635	6.0	35	red
120725	7.0	25	green
120730	7.0	30	green
120735	7.0	35	green
120750	7.0	50	green
120825	8.0	25	blue
120835	8.0	35	blue
120850	8.0	50	blue
121035	10.0	35	orange
121050	10.0	50	orange
121060	10.0	60	orange
121250	12.0	50	grey
121260	12.0	60	grey
121275	12.0	75	grey
121460	14.0	60	black
121490	14.0	90	black

Expandet brand Metal Cavity Anchors

for fixing in plaster boards, chipboards, gypsum fiber boards and other walls with cavities



Art. No.	size (mm)	pcs/box
904032	4 x 32	100
904045	4 x 45	100
905052	5 x 52	100
905065	5 x 65	100
906052	6 x 52	100
906065	6 x 65	50

Expandet brand Wall Plugs

for fixing in solid brick and concrete



Art. No.	size (mm)	pcs/box
260420	4.0 x 20	100
260525	5.0 x 25	100
260630	6.0 x 30	100
260840	8.0 x 40	100
261050	10.0 x 50	50
261260	12.0 x 60	25
261470	14.0 x 70	20
261680	16.0 x 80	15
262090	20.0 x 90	10

Expandet brand Expansion Shield

is suitable for fixing of heavy objects in concrete and solid brick. Used with set screw, threaded rod, bolts, etc.



Art. No.	size (mm)	pcs/box
HAC 240	M 6 x 40	50
HAC 250	M 8 x 50	50
HAC 260	M 10 x 60	50
HAC 270	M 12 x 80	25
HAC 280	M 16 x 100	10

Expandet brand Chemical Anchors



Art. No.	size	length (mm)
900008	8	80
900010	10	80
900012	12	95
900016	16	95
900020	20	170
900024	24	210

Fixing Materials



Expandet brand Wall Plugs

strong fastening solution in plasterboards, gypsum fibre boards, chipboards and other cavity walls. easy installation, no special tools required. also works effectively in cavities with insulation.

Colour BLUE: for one layer plasterboards
Thickness of board: 9-18 mm, TX 25

Colour RED: for two layer plasterboards
Thickness of board: 18-30 mm, TX 25

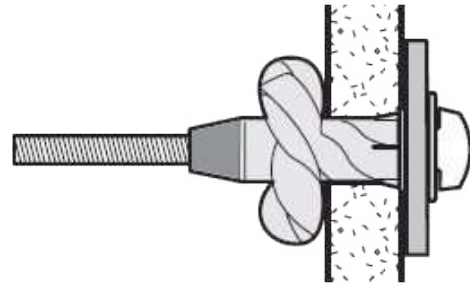

when the screw is tightened, the plug forms a strong knot on the back of board (in the cavity)

Art. No.	description	size (mm)	PU
410132/EGK	wall plug red, pan head	5 x 65	4
410133/EGK	wall plug blue, pan head	5 x 55	4
410632/EGK	wall plug red, countersunk	5 x 75	4
410633/EGK	wall plug blue, countersunk	5 x 65	4

Expandet brand metal toggle anchor, zinc plated

with threaded bars for fixing lightweight in ceiling
each set in a bag including nut + washer

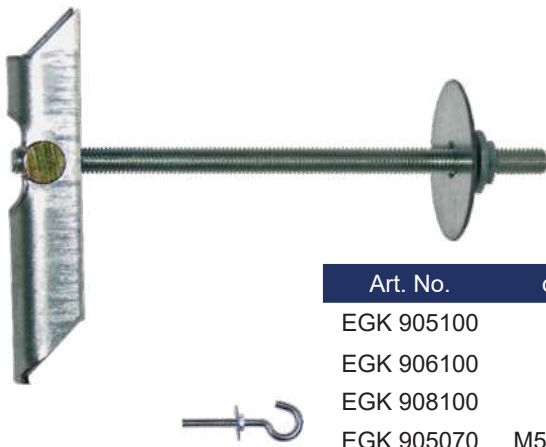

Art. No.	description
EGK 905100	M5 x 100
EGK 906100	M6 x 100
EGK 908100	M8 x 100
EGK 905070	M5 x 70 w. hook

Expandet brand metal spring toggles

with threaded bars for fixing lightweight in ceiling
each set in a bag including nut + washer



Art. No.	description
EGK 903085	M3 x 85
EGK 904090	M4 x 90
EGK 903070	M3 x 70 w. hook
EGK 904070	M4 x 70 w. hook

Drywall Screws for steel, with bugle head

PH2 - phosphated

Art. No.	size (mm)	pcs/box
EGK 335025	3,5 x 25	1000
EGK 335038	3,5 x 38	1000
EGK 335050	3,5 x 51	500



Jet Drive Anchors for fixing lightweight objects in plasterboard

supplied with screw 4.5 x 30 mm

Art. No.	size (mm)	material	pcs/box
961001	14 x 32	nylon	100
961000	14 x 32	metal	100



Anchors for hollow bricks and plasterboard panel walls

Art. No.	size (mm)	PU
282630/EGK	6 x 30 mm	4 pcs per bag
282840/EGK	8 x 40 mm	4 pcs per bag

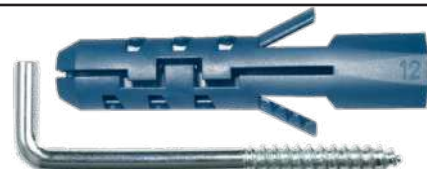

Furniture Nails

Please add colour code to Art. No.:

No. 050 - brass plated, polished

No. 013 - burnished light

No. 058 - brass relieved, polished

No. 031 - nickel plated, polished

No. 055 - old gold spotted light

No. 011 - copper relieved, polished

No. 054 - old gold spotted normal

Flat Head Chair Nails



Domed Head Chair Nails



Decorative Nails



Art. No.	head dia.	head height	PU
1 1/4	6.0	1.60	1000
20 1/3	6.5	1.8	1000
50 1/3	7.5	2.20	1000
60 1/3	8.0	2.30	1000
90 1/3	9.0	2.40	1000
100 1/3	9.5	2.50	1000
110 1/3	10.0	2.80	1000
130 1/3	11.0	2.80	1000
160 1/3	12.5	3.00	1000
1507	14.0	4.00	1000
1505	16.0	4.20	500
1504	18.0	4.50	500
1503	20.0	5.00	500
1501	22.0	5.50	500
1500	24.0	6.00	250
1499	26.0	8.00	250
1498	28.0	7.00	250
1497	30.0	8.00	250

Art. No.	head dia.	head height	PU
5/0	4.0	1.70	1000
3/0	4.5	1.80	1000
0	5.5	2.20	1000
20 1/2	6.5	2.50	1000
610	8.0	3.00	1000
630	9.0	3.40	1000
650	10.0	3.80	1000
660	10.5	4.00	1000
670	11.0	4.20	1000
507	12.5	4.50	1000
506	14.0	5.00	500
504	16.0	5.70	500
503	18.0	6.00	500
502	20.0	7.00	500
500	22.0	7.60	250
499	25.0	8.50	250

Art. No.	head dia.	head height	PU
549/W	10.0	3.0	1000
548/W	12.0	3.5	1000
547/W	14.0	4.0	1000
546/W	16.0	4.4	500
545/W	19.0	5.0	500



Art. No.	head dia.	head height	PU
510/A	9.0	4.0	1000
508/A	12.0	4.5	1000
500/A	22.0	8.5	250



Art. No.	head dia.	head height	PU
506/O	14.0	5.0	1000
504/O	17.5	7.0	500



Art. No.	head dia.	head height	PU
558/A	12.0	3.5	1000
555/A	20.0	4.0	500



Art. No.	head dia.	head height	PU
548/WH	12.0	4.0	1000



Art. No.	head dia.	head height	PU
1611/M	11.0	4.0	1000

Fixing Materials

PRYM brand Eyelets and Washers

of brass, matt



Art. No.	head dia.	head height	PU
541112**	8.0	0B	1000
541345**	9.5	2B	200
541335	10.5	3B	200
541079	11.5	4B	200
541242	12.5	5B	200
541396	13.5	6B	200
541182	14.0	7B	200
541087	15.0	8B	100
541178	17.5	9B	100
541410	19.5	10B	100
541094**	23.5	12B	100

Art. No.	head dia.	head height	PU
541113**	8.0	0B	1000
541357**	9.5	2B	200
541336	10.5	3B	200
541080	11.5	4B	200
541243	12.5	5B	200
541347	13.5	6B	200
541372	14.0	7B	200
541088	15.0	8B	100
541549	17.5	9B	100
541387	19.5	10B	100
541093**	23.5	12B	100

** polished version

** polished version

Eyelet and Washer Puncher

consisting of upper and lower part

Art. No.	d Ø (mm)	weight (kg)
1500008	8	0,325
1500010	10	0,640
1500012	12	0,640
1500014	14	0,700
1500016	16	0,900
1500018	18	0,900
1500020	20	0,900
1500025	25	1,050
1500028	28	1,200
1500032	32	1,650
1500036	36	2,300
1500040	40	2,475

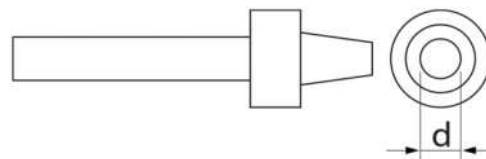

Fixing Materials



Eyelet Pliers MAMMUT

- Pressing Power of up to 1 ton!
- simple tool to change
 - manual plier with gigantic force
 - for DIN eyelets 14 - 20 mm
 - Punching and pressing eyelets without changing tool



Art. No.	length	weight (g)
0920-5000	500 mm 19"	1500

Art. No.	version
0920-5214	Tool insert Ø 14 mm (pair)
0920-5216	Tool insert Ø 16 mm (pair)
0920-5218	Tool insert Ø 18 mm (pair)
0920-5220	Tool insert Ø 20 mm (pair)

DIN Eyelets MAMMUT

bright brass finish



Art. No.	eyelets	version
0920-8140	Ø 14 mm	Bright brass
0920-8160	Ø 16 mm	Bright brass
0920-8180	Ø 18 mm	Bright brass
0920-8200	Ø 20 mm	Bright brass

DIN Eyelets Two in One

bright brass finish



Art. No.	eyelets	version
9100-3640	Ø 4.5 mm	Bright brass
9100-3645	Ø 5.0 mm	Bright brass
9100-3650	Ø 5.5 mm	Bright brass

for eyelet pliers please refer to page 182

Mason cords

on spools of 50 m,
12 spools per carton



Art. No.	Ø (mm)	colour
P23R	1.0	red
P23W	1.0	white
P232R	2.0	red
P232W	2.0	white
P233R	3.0	red
P233W	3.0	White

Polypropylene Cords - Multifil

12 spools per carton



Art. No.	Ø (mm)	colour	length
N8500W	1.0	white	100 m
N85200W	2.0	white	100 m
N85300W	3.0	white	100 m
N85400W	4.0	white	100 m
N85500W	5.0	white	100 m
N85600W	6.0	white	100 m



Other colours are available on request

Window and Door Weatherstrips

Premium Door-Weatherstrips

- self adhesive
- for gaps up to 18 mm
- for smooth, slightly uneven floors as well as textile floors (interior)
- Vinyl body
- Soft nylon brush

Art. No.	colour	length (m)	height (mm)	packing unit
3565331	white	1	54	10
3565332	brown	1	54	10



Standard Door-Weatherstrips

- self adhesive
- for gaps up to 18 mm
- for smooth, slightly uneven floors (interior)
- with polypropylene brush

Art. No.	colour	length (m)	height (mm)	packing unit
3565342	white	1	46	10
3565343	brown	1	46	10
3565341	transparent	1	46	10
3565349	black	1	46	10
3565347	hazel	1	46	10
3565348	beech	1	46	10



Universal Door-Weatherstrips

- self adhesive
- for gaps up to 20 mm
- for smooth and slightly uneven floors (interior)
- with soft plastic sealing lip
- for use in damp locations

Art. No.	colour	length (m)	height (mm)	packing unit
3565351	white	1	44	10
3565352	brown	1	44	10
3565350	black	1	44	10



Window and Door Weatherstrips

Aluminium Door-Weatherstrips

- mounting with megastrap
- for gaps up to 20 mm
- for smooth and uneven floors (interior and exterior)
- with horsehair bristles

Art. No.	colour	length (m)	height (mm)	packing unit
3565305	silver matt	1	46	10



V-profile Weatherstrips

- self-adhesive
- for gaps up to 8 mm
- especially suited for the sealing of sliding doors
- extra smooth profile

Art. No.	colour	length (m)	height (mm)	packing unit
3565541	white	10	10	6



Door-Weatherstrips DUO QUICK

- double sided sealing, easy and quick application. no stick or screw
- suited for indoor use



Art. No.	colour	length (m)	height (mm)	width (mm)	packing unit
3565570	anthrazit	0,95	30	100	1

Anti-slip and Repair Tapes

Anti-slip Tape

self-adhesive anti-slip tape and stripes
to avoid slip hazards. more sure-footedness on
stairs, ladders or smooth surfaces



Art. No.	colour	length (m)	width (mm)	packing unit
3567011	black	3	19	6
3567012	black	3	38	3
3567013	transparent	3	19	6
3567014	transparent	3	38	3

Reinforced Repair Tape - PREMIUM

- reinforced repair tape
- high temperature and weather resistance
- to tear by hand

Art. No.	colour	length (m)	width (mm)	packing unit
3563040	silver	10	50	4
3563091	black	10	50	4
3563093	white	10	50	4
3563041	silver	25	48	3
3563098	black	25	48	3
3563042	silver	50	48	3
3563101	black	50	48	3



Reinforced Repair Tape - STANDARD

- reinforced repair tape
- high temperature and weather resistance
- to tear by hand

Art. No.	colour	length (m)	width (mm)	packing unit
3563090	silver	50	48	6
3563105	black	50	48	6
3563103	silver	25	48	6
3563104	silver	25	30	9



Repair Tapes

Transparent Repair Tape

especially suitable for repair of glass and transparent plastics



Art. No.	colour	length (m)	width (mm)	packing unit
3563092	transparent	10	50	4

Aluminium Foil Tape

aluminium-vaporised foil tape for sealing and isolating roof work or laying laminate. self-adhesive.

Art. No.	colour	length (m)	width (mm)	packing unit
3563294	silver	50	50	4



Self-amalgamating Repair Tape

ideal for household repairs, hobbies, plumbing and electrical industries.

- self-amalgamating polyisobutyl
- UV and weather resistant
- insulating against current (up to a maximum of 35.000 V)
- water resistant



Art. No.	colour	length (m)	width (mm)	packing unit
3563085	black	10	19	6

Repair Tapes

Insulation Tape

for repairing and insulating electric cables or lustre terminals

- up to 6000 Volts
- high temperature resistant
- self-extinguishing
- tested according to VDE 0340



Art. No.	colour	length (m)	width (mm)	packing unit
3563282	white	10	15	6
3563281	black	10	15	6
3563280	grey	10	15	6
3563283	red	10	15	6

Double-sided mounting Mirror Tape

double-sided mounting tape for fastening mirrors, mirror tiles etc. permanently, humidity resistant, for interior use

Art. No.	colour	length (m)	width (mm)	packing unit
3563055	white	1,5	19	6
3563056	white	5	19	6
3583057	white	66	19	15



Hooks & Carpet Tapes

Stainless Steel Hooks with Megastrip

high quality stainless steel hooks for fixing objects in bathroom and kitchen.

- strong hold up to 0,75 kg
- suitable for application on smooth surfaces
- attachment with fix-o-moll Megastrip
- clean removal
- waterproof

Art. No.	shape	dia (mm)	pieces	packing unit
3562926	round	35	2	6
3562927	oval	21 x 34	2	6



Plastic Hooks

these plastic hooks, equipped with self-adhesive mounting tape, are ideal for fixing objects in the household

- suitable for application on smooth surfaces such as tiles, in cabinets etc.

Art. No.	colour	pieces	width (mm)	height (mm)	packing unit
3566707	silver	1	32	54	5
3566706	white	1	32	54	5
3566705	silver	2	26	43	5
3566704	white	2	26	43	5
3566703	silver	3	15	24	5
3566702	white	3	15	24	5
3562924	silver	2	∅	35	6
3562925	white	2	∅	35	6



Carpet Tapes - STANDARD

- film tape
- normal load
- permanently double-sided adhesive
- versatile applicable
- -10 up to +60°C

Art. No.	length (m)	width (mm)	packing unit
3563195	5	50	4
3563196	10	50	4
3563197	25	50	3
3563198	5	38	5
3563199	10	38	5
3563200	25	38	5



Carpet Tapes & Crack Cover

Carpet Tapes - PROFI

- extra strong
- fabric-reinforced
- heavy load
- permanently double-sided adhesive



Art. No.	length (m)	width (mm)	packing unit
3563192	5	50	4
3563193	10	50	4
3563194	25	50	3

Carpet Tapes - SUPER

- fabric-reinforced
- heavy load
- permanently double-sided adhesive
- for rough surfaces
- -10 up to +60°C



Art. No.	length (m)	width (mm)	packing unit
3563191	5	50	4
3563189	10	50	4
3563190	25	50	3

Crack cover

- covering of cracks and plug holes
- paint and wallpaper can be applied directly after use
- invisible under wallpaper



Art. No.	colour	length (m)	width (mm)	packing unit
3563221	white	10	50	4

Crack cover fibreglass

- for plasterboard and dry wall joints
- for wall and ceiling repairs
- robust and sturdy



Art. No.	colour	length (m)	width (mm)	packing unit
3563222	white	20	50	4

Masking Tapes

Masking tape for straight clean edges

for straight clean edges on smooth surfaces in indoor areas.
reliable adhesion, no paint underflow, clean removal.

Art. No.	colour	length (m)	width (mm)	set/pcs	packing unit
3563011	chamois	50	19		7
3563012	chamois	50	25		6
3563013	chamois	50	30		5
3563014	chamois	50	38		4
3563015	chamois	50	50		3
3563111	ECO chamois	50	19		12
3563113	ECO chamois	50	30		8
3563115	ECO chamois	50	50		5
3563116	ECO chamois	3 x 50	30	3	1
3563118	ECO chamois	3 x 50	19 30 50	3	1



Coverfix 2in1

masking tape with attached foil - for razor-sharp masking and protection of large areas in a single step.

Art. No.	colour	length (m)	width (cm)	packing unit
3563177	Refill XL transparent	17	270	2
3563183	Refill L transparent	33	140	2
3563185	Refill M transparent	33	55	2



Protection foil Standard

for covering and protecting large areas during renovation. the electrostatically charged film clings to the surface and thus offers optimal protection from paint splashes.

Art. No.	colour	length (m)	width (m)	packing unit
3563016	20 m ² , 8µm transparent	4	5	20



Parcel Tapes

Parcel Tape PROFI

PVC no noise

Art. No.	colour	length (m)	width (mm)	packing unit
3563335	brown	66	50	6
3563336	transparent	66	50	6



Parcel Tape UNIVERSAL

PP no noise

Art. No.	colour	length (m)	width (mm)	packing unit
3563333	brown	66	50	6
3563334	transparent	66	50	6
3563337	brown	66	38	8
3563338	transparent	66	38	8



Parcel Tape BASIC PP

Art. No.	colour	set pcs	length (m)	width (mm)	packing unit
3563330	brown		66	48	6
3563331	transparent		66	48	6



Dispenser for parcel tape

standard dispenser for parcel tape for secure and clean sealing of packages. usable for rolls of 66 m. roll breadth up to 50 mm.

Art. No.	length of roll	max. roll breadth
3563341	66 m	50 mm



Door Wedges

Door Wedges

doors are securely fixed with a door wedge and the slamming of doors is prevented.

Art. No.	colour	pieces	length (mm)	width (mm)	packing unit
3566691	transparent	1	100	28	5
3566690	transparent	1	98	36	6
3566689	black	1	97	40	6



Hook and Loop Tape

- self-adhesive
- can be cut to size
- hold light objects

Art. No.	colour	length (cm)	width (mm)	packing unit
3563405	white	60	20	6
3563406	black	60	20	6
3563407	light-grey	60	20	6
3563002	white	150	20	4
3563003	black	150	20	4
3563413	light-grey	150	20	4
3563411	white	300	20	4
3563412	black	300	20	4



Touch fastener pads and dots

- self-adhesive
- pre-assembled, glued directly
- hold light objects

Art. No.	colour	sets	length (mm)	width (mm)	packing unit
3563422	white	12	25	25	15
3563423	black	12	25	25	15
3563421	black-grey	4	48	25	15
3563424	white	2	Ø	35	15
3563425	black	2	Ø	35	15
3563426	red	8	Ø	20	15
3563427	white	8	Ø	20	15
3563428	black	8	Ø	20	15



Plastic Gliders and Door Stops

Carpet Gliders

carpet gliders allow the movement of furniture or objects on textile surfaces. laminates, tiles etc. and carpets are safely protected. self-adhesive carpet gliders made of durable plastic with very good gliding abilities and sound absorbing felt insert.



Art. No.	colour	pieces	dia (mm)	packing unit
3566467	white	8	18	15
3566468	white	8	22	15
3566469	white	8	26	15

Cork Pads

cork pads are fastened under movable objects and protect furniture surfaces against scratches and damages. self-adhesive.



Art. No.	pieces	length (mm)	width (mm)	height (mm)	packing unit
3566392	9	Ø	28	2,1	5
3566393	1	200	100	2,1	5
3566390	30	12	12	2,1	5
3566391	9	Ø	21	2,1	5

Protection Buffers

protection against damages, self-adhesive



Art. No.	colour	pieces	length (mm)	width (mm)	packing unit
3566673	white	9	Ø	21	15
3566674	white	9	Ø	28	15
3566675	white	9	28	28	15
3566676	white	1	200	100	15

Door Stops

protect walls and furniture against damage from slamming doors. with plug and screw.



Art. No.	colour	pieces	dia (mm)	packing unit
3566680	white	2	22	5
3566681	beige	2	22	5
3566682	brown	2	22	5
3566683	transparent	2	22	5
3566684	white	1	30	5
3566685	light grey	1	30	5
3566687	white	1	40	5
3566686	light grey	1	40	5
3566688	white	2	21	6

Felt Gliders

Felt Gliders and Felt Pads, self-adhesive

self-adhesive felt gliders allow the effortless movement of furniture or objects on smooth surfaces without either noise or damage to the floor. laminates, tiles etc. are safely protected. made of abrasion-resistant needle felt, with strong adhesive for simple and secure fastening.

Art. No.	colour	length (mm)	width (mm)	height (mm)	set/pcs	packing unit
3566300	white	Ø	17	3	20	15
3566340	brown	Ø	17	3	20	15
3566320	white	22	22	3	16	15
3566360	brown	22	22	3	16	15
3566327	white	16	44	3	8	15
3566367	brown	16	44	3	8	15

Many other sizes available on request



Felt Gliders with Pin

felt gliders with pin allow the effortless movement of chairs or tables on smooth surfaces without either noise or damage to the floor. laminates, tiles etc. are safely protected. made of abrasion-resistant needle felt, simple and secure fastening with pin, suitable for wooden furniture legs. wooden furniture legs must be pre-drilled.



Art. No.	colour	pieces	dia (mm)	packing unit
3566201	white	8	20	4
3566210	brown	8	20	4
3566202	white	16	20	4
3566211	brown	16	20	4
3566204	white	8	24	4
3566213	brown	8	24	4
3566207	white	4	28	4
3566216	brown	4	28	4

Many other sizes available on request

Felt Gliders with Screws

parquet gliders with screw allow the gentle and safe movement of chairs or tables without either noise or damage to the floor. exclusive tiles, fine parquet and top-quality laminates are safely protected against nasty scratches. simple and secure fastening with screw, stable metal socket and very thick and smooth gliding felt layer ensure long durability and top wear and abrasion resistance of the parquet gliders. suitable for wooden furniture legs. wooden furniture legs must be pre-drilled.



Art. No.	colour	pieces	dia (mm)	packing unit
3566230	nature	4	20	4
3566231	nature	16	20	4
3566147	nature	4	24	4
3566148	nature	16	24	4
3566237	nature	4	28	4
3566169	nature	16	28	4

Glass Sliding Door Fittings

Aluminium Glass Sliding Door Fittings
Made in Germany

Precise and elegant aluminium profiles in combination with runners ensure smooth and quiet functionality. The fitting features great variety of application by simply altering the basic parts.



silver

Art. No.: 57700.68.29

Aluminium profiles are available in brass or silver anodized finish, supplied in sets including all necessary accessories.

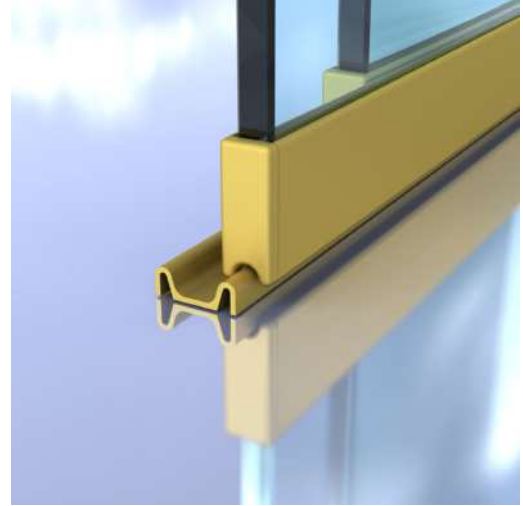

gold

Art. No.: 57700.71.29

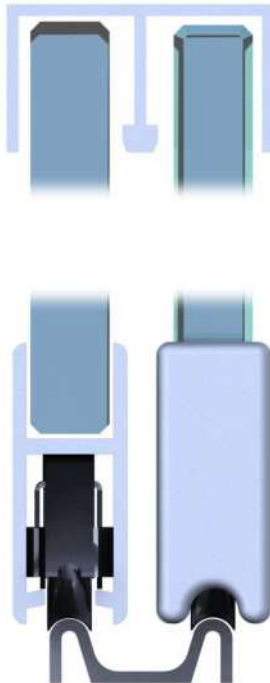

Technical details

- suitable for glass panes of 6 or 8 mm thickness
- 4 runners holding glass panes up to 140 kgs weight
- zinc-plated steel runners with noise reducing ball bearings
- self-adhesive twin track bottom rail
- easy and quick assembling with special mounting tool
- all profile surfaces equipped with transparent protection foil



easy fix

Content per case (brass or silver coloured)

- 10 x 5 mtr. aluminium twin track bottom rail
- 10 x 5 mtr. aluminium shoe rail
- 10 x 5 mtr. aluminium top rail
- 100 pieces plastic end cap in matching colour
- 150 pieces steel runner, zinc plated
- 5 pieces runner mounting tool

Shelving Systems



Wall Uprights - Single Slotted

suitable as end elements for wall mounted shelf units in combination with double slotted uprights - pair packing

RAL 9003 white
RAL 9006 silver
RAL 9005 black

Art. No.	Art. No.	Art. No.	length (cm)
RAL 9003 white	RAL 9006 silver	RAL 9005 black	
10000-00000	10000-00005	10000-00001	50
10000-00017	10000-00023	10000-00018	100
10000-00028	10000-00034	10000-00029	150
10000-00039	10000-00044	10000-00040	200
10000-00049	10000-00054		250



Wall Uprights - Double Slotted

permit shelves, baskets, ets. to be mounted immediately alongside each other - pair packing

RAL 9003 white
RAL 9006 silver
RAL 9005 black

Art. No.	Art. No.	Art. No.	length (cm)
RAL 9003 white	RAL 9006 silver	RAL 9005 black	
10001-00001	10001-00005	10001-00002	50
10001-00010	10001-00014	10001-00011	100
10001-00019	10001-00023	10001-00020	150
10001-00028	10001-00032	10001-00029	200
10001-00037	10001-00041		250



Clip-On Holders

support for wooden and glass shelves, 12 pcs/box

Art. No.	details
11604-00001	single sided
11612-00001	double sided

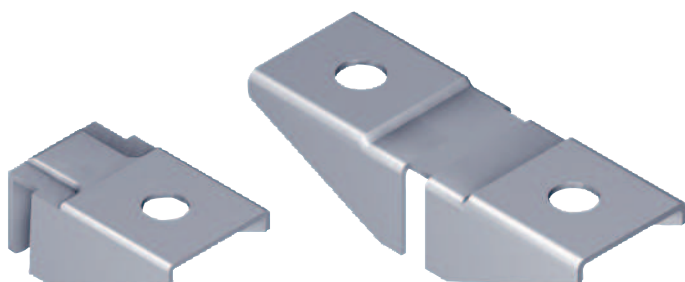

Suction Pads

can be installed on clip-on and insert holders to support glass or wooden shelves, Ø 13,5 mm, 20 pcs/box

Art. No.
11605-00001



Shelving Systems



Angle Brackets

suspension hooks, specific left-hand and right-hand, designs permit use as attractive brackets for the ends of shelves - pair packing

RAL 9003 white
RAL 9006 silver
RAL 9005 black

Art. No. RAL 9003 white	Art. No. RAL 9006 silver	Art. No. RAL 9005 black	length (cm)
10300-00019	10300-00023	10300-00020	18
10300-00026	10300-00030	10300-00027	23
10300-00033	10300-00037	10300-00034	28
10300-00040	10300-00044	10300-00041	33
10300-00047	10300-00051	10300-00048	38
10300-00000	10300-00004	10300-00001	48

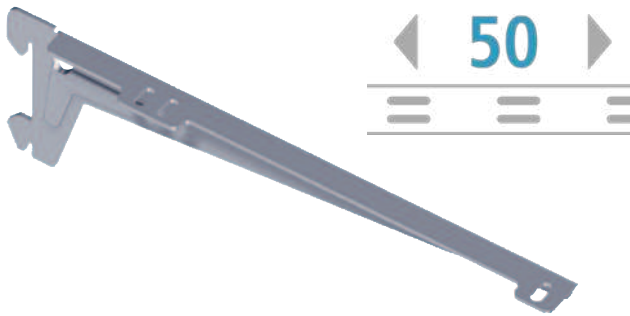

Safety Brackets, Two Lugs, Shelf Support

Locking System
can be used with all types of wall uprights

RAL 9003 white
RAL 9006 silver
RAL 9005 black

Art. No. RAL 9003 white	Art. No. RAL 9006 silver	Art. No. RAL 9005 black	length (cm)
10105-00001	10105-00008	10105-00002	10
10105-00101	10105-00103	10105-00102	15
10105-00201	10105-00203	10105-00202	20
10105-00301	10105-00303	10105-00302	25
10105-00401	10105-00403	10105-00402	30
10105-00501	10105-00503	10105-00502	35
10105-00601	10105-00603	10105-00602	40
10105-00801	10105-00803	10105-00802	50

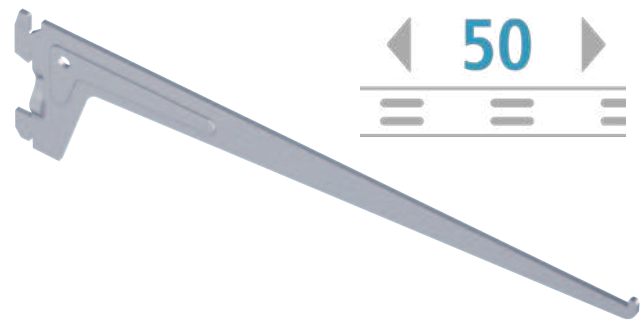

U-Brackets

can be used with double slotted wall upright

RAL 9003 white
RAL 9006 silver
RAL 9005 black

Art. No. RAL 9003 white	Art. No. RAL 9006 silver	Art. No. RAL 9005 black	length (cm)
10201-00002	10201-00006	10201-00003	17
10201-00008	10201-00012	10201-00009	22
10201-00015	10201-00019	10201-00016	27
10201-00021	10201-00025	10201-00022	37
10201-00027	10201-00031	10201-00028	47

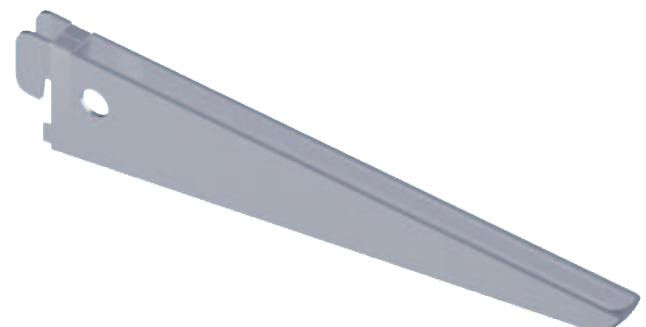

Shelving Systems



Steel Shelves

can be used with brackets - Ref. 10105

RAL 9003 white
RAL 9006 silver
RAL 9005 black

Art. No.	Art. No.	Art. No.	length (cm)
RAL 9003 white	RAL 9006 silver	RAL 9005 black	
10700-00004	10700-00010	10700-00007	20 x 80
10700-00012	10700-00018		25 x 80
10700-00020	10700-00025	10700-00022	30 x 80
10700-00027	10700-00033	10700-00031	35 x 80



Perforated Steel Panels

suitable for use with with all wall-mounted tracks

RAL 9003 white
RAL 9006 silver

Art. No.	Art. No.	length (cm)
RAL 9003 white	RAL 9006 silver	
11400-00004	11400-00007	20 x 80

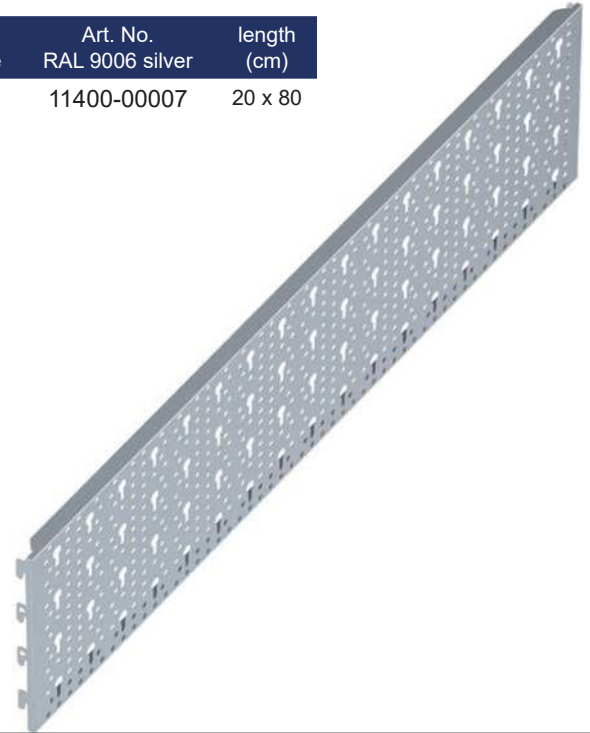

Shelf Set Storage

- flexible shelf solution with 2 TWIN wire shelves
- TWIN wire shelves allow an optimal view of the content on your shelf - especially at higher levels
- TWIN wire shelves provide almost no space for dust and allow an optimal air circulation
- quick and easy to install
- compact solution for areas such as office, pantry, garage, workshop, laundry etc.
- colour: white aluminium



Art. No.	dimensions (w x h x d)	max. load	PU
11356-01030	828 x 496 x 332 mm	20 kg / 44 lbs	7



set contents	Qty
wall upright double, 500 mm, white aluminium	2
twin wire shelf bracket, 320 mm, white aluminium	4
twin wire shelf, 800 x 300 mm, white aluminium	2
screws and dowels in wrapping	6

Shelving Systems



Shelf Set Office 3

- flexible shelf solution with 2 steel shelves
- the washable surface of steel shelves makes them ideally suited for wide ranging applications
- quick and easy to install
- compact solution for areas such as office, pantry, garage, workshop, laundry etc.
- colour: white



Art. No.	dimensions (w x h x d)	max. load
11356-00000	828 x 496 x 320 mm	30 kg / 66 lbs



set contents	Qty
wall upright double, 500 mm, white	2
bracket, 300 mm, white	4
steel shelf, 800 x 300 mm, white	2
screws and dowels in wrapping	6

Shelf Set Walk-in Closet

- flexible wardrobe solution with 3 TWIN wire shelves
- quick and easy to install
- used in areas such as corridor, walk-in closet, wardrobe, laundry room etc.
- colour: white



Art. No.	dimensions (w x h x d)	max. load
11356-00010	996 x 911 x 331 mm	shelf: 20 kg / 44 lbs tube: 15 kg / 33 lbs

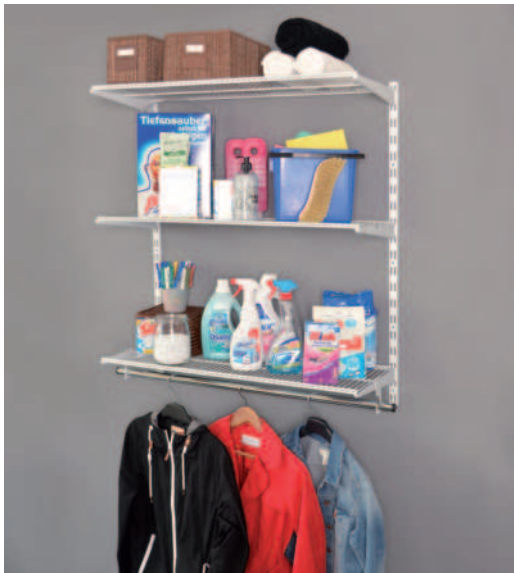

set contents	Qty
wall upright double, 1000 mm, white	2
twin wire shelf bracket, 320 mm, white	6
twin wire shelf, 800 x 300 mm, white	3
twin tube, 900 mm, chrome	1
twin tube holder + endcap-set, white	1
screws and dowels in wrapping	12

Electric Door Openers

eff-eff brand Electric Door Openers „FaFix“

new model - surface mounted for case locks with wide springbolts, suitable for DIN left or right mounting
 - with adjustable and fixable electric strike latch bolt
 - ideal to compensate for expansion at any time



eff-eff brand Electric Door Openers



- suitable for all common striking plates
 - suitable for DIN right and left due to 180° fitting, 6-12V



10 K-118 A3002D1119



14 / D11



17 / D11

Art. No.	Power	Size
10 K-118	6 - 12 V	132 x 65 x 24 mm
14 / D11	6 - 12 V	90 x 20 x 28,2 mm
17 / D11	6 - 12 V	75 x 20,5 x 28 mm

KISTENMACHER brand Electric Door Openers

new model - surface mounted for case locks with wide springbolts, suitable for DIN left or right mounting
 - with adjustable and fixable electric strike latch bolt
 - ideal to compensate for expansion at any time



Art. No.	Power	Size	Colour
ES10K/6-12b	6 - 12 V	132 x 62 x 24 mm	black
ES10K/6-12g	6 - 12 V	132 x 62 x 24 mm	grey

Castor Wheels



Castor Wheels Series ALPHA

housing made of pressed steel, bright zinc plated,
wheel centre made of pressed steel
Tread: solid rubber, black, roller bearing



BETTER MOBILITY. BETTER LIFE.

Plate fitting

Bolt Hole



Swivel Type

Fixed Type

Brake Type



double ball bearing swivel head,
dustguard, wheel axle with nut

fork made of pressed steel,
bright zinc plated, wheel axle
with nut

with total lock, tail end of castor,
double ball bearing swivel head,
dustguard, wheel axle with nut

Art. No. swivel type	Art. No. fixed type	Art. No. brake type	size (mm)	load capacity (kg)
3470 DVR 100 P62	3478 DVR 100 P62	3477 DVR 100 P62	100	70
3470 DVR 125 P62	3478 DVR 125 P62	3477 DVR 125 P62	125	100
3470 DVR 160 P63	3478 DVR 160 P63	3477 DVR 160 P63	160	135
3470 DVR 200 P63	3478 DVR 200 P63	3477 DVR 200 P63	200	205



BETTER MOBILITY. BETTER LIFE.

Castor Wheels



BETTER MOBILITY. BETTER LIFE.

Castor Wheels Series ALPHA

housing made of pressed steel, bright zinc plated,
wheel centre made of polypropylene
Tread: solid rubber, black, roller bearing

Swivel Type



double ball bearing swivel head,
dustguard, wheel axle with nut

Fixed Type



fork made of pressed steel,
bright zinc plated, wheel axle
with nut

Brake Type



with total lock, tail end of castor,
double ball bearing swivel head,
dustguard, wheel axle with nut

Art. No. swivel type	Art. No. fixed type	Art. No. brake type	size (mm)	load capacity (kg)
3470 PVR 080 P62	3478 PVR 080 P62	3477 PVR 080 P62	80	70
3470 PVR 100 P62	3478 PVR 100 P62	3477 PVR 100 P62	100	75
3470 PVR 125 P62	3478 PVR 125 P62	3477 PVR 125 P62	125	100
3470 PVR 160 P63	3478 PVR 160 P63	3477 PVR 160 P63	160	135
3470 PVR 200 P63	3478 PVR 200 P63	3477 PVR 200 P63	200	205

Stainless Steel Castor Wheels Series ALPHA

housing made of stainless steel, wheel centre made of polyamide, white
Tread: polyurethane, purple, roller bearing, stainless

Swivel Type



double ball bearing swivel head,
wheel axle with nut

Fixed Type



fork made of stainless steel,
wheel axle with nut

Brake Type



with total lock, tail end of castor,
double ball bearing swivel head,
wheel axle with nut

Art. No. swivel type	Art. No. fixed type	Art. No. brake type	size (mm)	load capacity (kg)
8470 UAD 080 P62	8478 UAD 080 P62	8477 UAD 080 P62	80	100
8470 UAD 100 P62	8478 UAD 100 P62	8477 UAD 100 P62	100	150
8470 UAD 125 P62	8478 UAD 125 P62	8477 UAD 125 P62	125	200
8470 UAD 160 P63	8478 UAD 160 P63	8477 UAD 160 P63	160	350
8470 UAD 200 P63	8478 UAD 200 P63	8477 UAD 200 P63	200	400

Castor Wheels

Castor Wheels Series ALPHA

housing made of pressed steel, bright zinc plated,
blue passivated, roller bearing, wheel centre made of polyamide
Tread: elastic-tyre, blue, non-marking



Swivel Type



double ball bearing swivel head,
wheel axle with nut, dustguard

Fixed Type



fixed castor, fork made of
pressed steel, wheel axle
with nut, plate fitting

Brake Type



with total lock, tail end of castor,
double ball bearing swivel head,
wheel axle with nut, dustguard

Art. No. swivel type	Art. No. fixed type	Art. No. brake type	size (mm)	load capacity (kg)
3470 UFR 100 P62 blue	3478 UFR 100 P62 blue	3477 UFR 100 P62 blue	100	160
3470 UFR 125 P62 blue	3478 UFR 125 P62 blue	3477 UFR 100 P62 blue	125	250



BETTER MOBILITY. BETTER LIFE.

Castor Wheels



Castor Wheels Series ALPHA

housing made of pressed steel, bright zinc plated,
wheel centre made of polyamide, black / white, roller bearing
all types optionally available in white colour!
size 200 mm only available in white colour!

* to order white version please add „white“ to the Art. No.



BETTER MOBILITY. BETTER LIFE.

Plate fitting

Bolt Hole



Swivel Type



double ball bearing swivel head,
dustguard, wheel axle with nut

Fixed Type



fork made of pressed steel,
bright zinc plated, wheel axle
with nut

Brake Type



with total lock, tail end of castor,
double ball bearing swivel head,
dustguard, wheel axle with nut

Art. No. swivel type	Art. No. fixed type	Art. No. brake type	size (mm)	load capacity (kg)
3470 UOR 100 P62	3478 UOR 100 P62	3477 UOR 100 P62	100	200
3470 UOR 125 P63	3478 UOR 125 P63	3477 UOR 125 P63	125	250
3470 UOR 160 P63	3478 UOR 160 P63	3477 UOR 160 P63	160	350
3470 UOR 200 P63	3478 UOR 200 P63	3477 UOR 200 P63	200	350



BETTER MOBILITY. BETTER LIFE.

Castor Wheels

Castor Wheels Series ALPHA

housing made of pressed steel, bright zinc plated, wheel centre made of polypropylene, dark grey, roller bearing

Swivel Type



double ball bearing swivel head, dustguard, wheel axle with nut

Fixed Type



fork made of pressed steel, bright zinc plated, wheel axle with nut

Brake Type



with total lock, tail end of castor, double ball bearing swivel head, dustguard, wheel axle with nut

Art. No. swivel type	Art. No. fixed type	Art. No. brake type	size (mm)	load capacity (kg)
3470 POR 080 P62	3478 POR 080 P62	3477 POR 080 P62	80	125
3470 POR 100 P62	3478 POR 100 P62	3477 POR 100 P62	100	160
3470 POR 125 P62	3478 POR 125 P62	3477 POR 125 P62	125	200

Castor Wheels Series AGILA-TWIN

housing made of pressed steel, bright zinc plated, wheel center made of polyamide, plain bearing

Swivel Type



double ball bearing swivel head, dustguard, wheel axle with nut

Brake Type



with wheel brake, tail end of castor, double ball bearing swivel head, wheel axle with nut

Art. No. swivel type	plate fitting / Bolt hole	Art. No. brake type	size (mm)	load capacity (kg)
2970 UOO 050 P40		2975 UOO 050 P40	50	70
2970 UOO 050 P30-11	bolt hole 11 mm	2975 UOO 050 P30-11	50	70



Castor Wheels



Castor Wheels Series ALPHA

housing made of pressed steel, bright zinc plated,
wheel centre made of polyamide, white, plain bearing



BETTER MOBILITY. BETTER LIFE.

Plate fitting

Bolt Hole



Swivel Type



Fixed Type



Brake Type



double ball bearing swivel head,
dustguard, wheel axle with nut

fork made of pressed steel,
bright zinc plated, wheel axle
with nut

with total lock, tail end of castor,
double ball bearing swivel head,
dustguard, wheel axle with nut

Art. No. swivel type	Art. No. fixed type	Art. No. brake type	size (mm)	load capacity (kg)
3470 UOO 080 P62	3478 UOO 080 P62	3477 UOO 080 P62	80	200
3470 UOO 100 P62	3478 UOO 100 P62	3477 UOO 100 P62	100	200
3470 UOO 125 P62	3478 UOO 125 P62	3477 UOO 125 P62	125	275
3470 UOO 160 P63	3478 UOO 160 P63	3477 UOO 160 P63	160	350
3470 UOO 200 P63	3478 UOO 200 P63	3477 UOO 200 P63	200	350



BETTER MOBILITY. BETTER LIFE.

Castor Wheels

Castor Wheels Series AGILA

housing made of pressed steel, bright zinc plated,
wheel centre made of Polypropylene
Tread: TENTEprene (thermoplastic rubber),
grey non-marking, plain bearing



BETTER MOBILITY. BETTER LIFE.

Plate fitting

Bolt Hole



Swivel Type



Fixed Type



Brake Type



double ball bearing swivel head,
dustguard, wheel axle with nut

fixed castor, fork made of
pressed steel, wheel axle
with nut, plate fitting

with total lock, tail end of castor,
double ball bearing swivel head,
dustguard, wheel axle with nut

Art. No. swivel type	Art. No. fixed type	Art. No. brake type	size (mm)	load capacity (kg)	plate fitting / bolt hole
2470 PJI 050 P40	2478 PJI 050 P41	2475 PJI 050 P40	50	40	plate fitting
2470 PJO 075 P40	2478 PJO 075 P60	2477 PJO 075 P40	75	75	plate fitting
2470 PJO 100 P50	2478 PJO 100 P50	2477 PJO 100 P50	100	80	plate fitting
2470 PJO 125 P50	2478 PJO 125 P50	2477 PJO 125 P50	125	100	plate fitting
2470 PJO 150 P50	2478 PJO 150 P50	2477 PJO 150 P50	150	100	plate fitting
2470 PJI 050 P30		2475 PJI 050 P30	50	40	11 mm hole
2470 PJO 075 P30		2477 PJO 075 P30	75	75	11 mm hole
2470 PJO 100 P30		2477 PJO 100 P30	100	80	11 mm hole
2470 PJO 125 P30		2477 PJO 125 P30	125	100	11 mm hole
2470 PJO 150 P30		2477 PJO 150 P30	150	100	11 mm hole



BETTER MOBILITY. BETTER LIFE.

Castor Wheels



Castor Wheels Series AGILA

housing made of pressed steel, bright zinc plated,
wheel centre made of pressed steel
Tread: solid rubber, with threadguards,
grey non-marking, cone ball bearing



BETTER MOBILITY. BETTER LIFE.

Plate fitting

Bolt Hole



Swivel Type

Fixed Type

Brake Type



double ball bearing swivel head,
wheel axle with nut

fixed castor, fork made of
pressed steel, wheel axle
with nut, plate fitting

with total lock, tail end of castor,
double ball bearing swivel head,
wheel axle with nut

Art. No. swivel type	Art. No. fixed type	Art. No. brake type	size (mm)	load capacity (kg)	plate fitting / bolt hole
2470 DIK 050 P40	2478 DIK 050 P40		50	40	plate fitting
2470 DIK 075 P40	2478 DIK 075 P60	2477 DIK 075 P40	75	55	plate fitting
2470 DIK 100 P50	2478 DIK 100 P50	2477 DIK 100 P50	100	80	plate fitting
2470 DIK 125 P50	2478 DIK 125 P50	2477 DIK 125 P50	125	100	plate fitting
2470 DIK 150 P50	2478 DIK 150 P50	2477 DIK 150 P50	150	100	plate fitting
2470 DIK 050 P30			50	40	11 mm hole
2470 DIK 075 P30		2477 DIK 075 P30	75	55	11 mm hole
2470 DIK 100 P30		2477 DIK 100 P30	100	80	11 mm hole
2470 DIK 125 P30		2477 DIK 125 P30	125	100	11 mm hole
2470 DIK 150 P30		2477 DIK 150 P30	150	100	11 mm hole



BETTER MOBILITY. BETTER LIFE.

Castor Wheels

Castor Wheels Series LEVINA

housing and wheels made from high grade synthetic materials, wheel centre made of polypropylene
Tread: TENTEprene (thermoplastic rubber), grey non-marking



BETTER MOBILITY. BETTER LIFE.

Plate fitting

Bolt Hole



Swivel Type



Brake Type



precision ball bearing

with total lock, tail end of castor, precision ball bearing

Art. No. swivel type	Art. No. brake type	size (mm)	load capacity (kg)
5370 PJP 100 P50	5377 PJP 100 P50	100	100
5370 PJP 125 P50	5377 PJP 125 P50	125	100
5370 PJP 150 P50	5377 PJP 150 P50	150	100

Castor Wheels for Shopping Trolleys

swivel castor, housing made of pressed steel, bright zinc plated, double ball bearing swivel head, wheel axle with nut, wheel centre made of polypropylene.
Tread: TENTEprene (thermoplastic rubber), grey non-marking, precision ball bearing, with threadguards, bolt hole

Art. No. swivel type	size (mm)	load capacity (kg)	plate fitting / bolt hole
2370 PJP 100 P30	100	100	bolt hole 11
2370 PJP 125 P30	125	100	bolt hole 13



BETTER MOBILITY. BETTER LIFE.

Castor Wheels



BETTER MOBILITY. BETTER LIFE.

Medical - Bed Castor Wheels Series INTEGRAL

Swivel castor with central, total lock and central directional lock, stem with cam hole for profile bars. Wheel centre made of polyamide, electric conductive, with threadguards
Tread: polyurethane, precision ball bearing, sealed



Medical - Bed Castor Wheels Series SMART

Swivel castor with central total lock, stem with cam hole for profile bars. Wheel centre made of polyamide, electric conductive, with threadguards
Tread: polyurethane, precision ball bearing, sealed



Art. No. swivel type	size (mm)	load capacity (kg)
2044 XSX 125 R26-28S45	125	150
2044 XSX 150 R26-28S45	150	150
2044 XSX 200 R26-28S45	200	150

Art. No. swivel type	size (mm)	load capacity (kg)
2046 XSX 125 R26-28S45	125	150
2046 XSX 150 R26-28S45	150	150
2046 XSX 200 R26-28S45	200	150

Castor Wheels Series INTEGRAL

Swivel castor with central, total lock, and central directional lock, frame made of pressed steel, wheel centre made of polyamide
Tread: Polyurethane, with threadguards, precision ball bearing



Castor Wheels Series INTEGRAL

Swivel castor with central, total lock, and central directional lock, frame made of pressed steel, wheel centre made of polyamide
Tread: Polyurethane, with threadguards, precision ball bearing



Art. No. swivel type	size (mm)	load capacity (kg)
2044 UAX 200 R26-28S45	200	150

Art. No. swivel type	size (mm)	load capacity (kg)
2046 UAX 200 R26-28S45	200	150

Castor Wheels



Heavy Duty Castor Wheels Series ZETA

housing made of very heavy pressed steel, reinforced, bright zinc-plated, wheel centre made of aluminium
Tread: black elastic-tyre, vulcanized, precision ball bearing

Swivel Type



sealed swivel double ball bearing, reinforced and heat treated ball covers, riveted king pin, wheel axle with nut

Fixed Type



fork made of heavy pressed steel, reinforced, bright zinc plated, wheel axle with nut

Brake Type



with wheel brake, double ball bearing swivel head, wheel axle with nut

Art. No. swivel type	Art. No. fixed type	Art. No. brake type	size (mm)	load capacity (kg)
4680 IEP 125 P63	4688 IEP 125 P63	4687 IEP 125 P63	125	300
4680 IEP 160 P63	4688 IEP 160 P63	4687 IEP 160 P63	160	350
4680 IEP 200 P63	4688 IEP 200 P63	4687 IEP 200 P63	200	450
4680 IEP 250 P63	4688 IEP 250 P63	4687 IEP 250 P63	250	500

Heavy Duty Castor Wheels Series KAPPA

housing and plate steel welded, bright zinc plated, wheel centre made of aluminium
Tread: polyurethane, casted, precision ball bearing

Swivel Type



sealed single swivel double ball bearing, riveted king pin, wheel axle with nut

Fixed Type



fork and plate steel welded, bright zinc plated, wheel axle with nut

Brake Type



with total lock, head end of castor, sealed single swivel double ball bearing, threaded king pin and locking nut secured, wheel axle with nut

Art. No. swivel type	Art. No. fixed type	Art. No. brake type	size (mm)	load capacity (kg)
9680 ITP 100 P63	9688 ITP 100 P63	-	100	540
9680 ITP 125 P63	9688 ITP 125 P63	9682 ITP 125 P63	125	500
9680 ITP 160 P63	9688 ITP 160 P63	9682 ITP 160 P63	160	800
9680 ITP 200 P63	9688 ITP 200 P63	9682 ITP 200 P63	200	800
9680 ITP 250 P63	9688 ITP 250 P63	9682 ITP 250 P63	250	1000



E-DRIVE FLEX - electrical driving unit



Increased productivity

E-Drive flex helps to make design operational procedures more efficient and, as a result, to realise cost savings.

High flexibility

Thanks to the lifting motor, E-Drive flex can be switched on as required and has no ground contact when in standby position. The practical system also makes it easy to integrate this into existing transport devices.

Improved ergonomics

The ergonomic system helps to prevent ailments to the neck, back, shoulders and hands among users - especially in times of high demographic change. Your investment in E-Drive flex will quickly bear fruit through fewer illness-related absences.



Application example of E-Drive flex

Foldable transport trolley with all E-Drive flex components. The battery displayed here is the lithium-ion battery set.

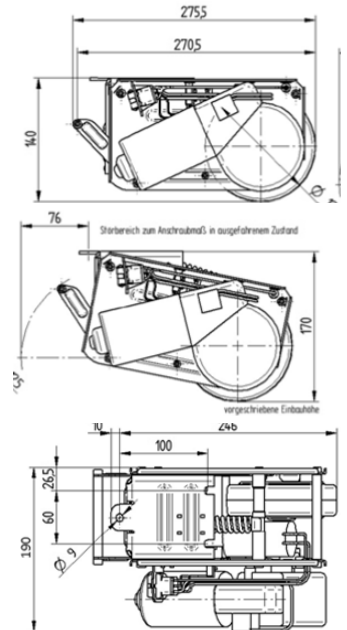

BETTER MOBILITY. BETTER LIFE.

Index

	page		page
A		C	
Abrasive Cloth	9	Cable Extension Reels - Schuko	192
Abrasive Flap Wheels	10-11	Cable Extension Reels - BS	183 - 186 + 189
Adhesive Tapes	227 - 233	Calipers	174 - 176
Adjustable Wrenches	121	Car Body Files	116
Air Chucks	84	Car Body Repair Tools	35
Air Guns	203	Cable Shears	121
Air Fittings	85-86	Car Washing Guns	82 - 83
Air Maintenance Units	80	Carpet Tape	230 - 231
Allen Keys + Sets	41 - 46	Carpet Grippers	149
Aluminium Welding Sticks	214	Castor Wheels	243 - 254
Anchors	219 - 221	Castor Wheels - Heavy Duty	253
Arbors for Hole Saws	113	Castor Wheels - Medical	252
Arch Punches + Sets	61	Ceiling Brushes	143
Axes	135	Center Drill Bits	112
Axe Handles	138	Centre Punches	62 - 63
		Chain Connectors	162
		Chair Nails	222
		Chisels	60
B		Circlip Pliers	120
Backing Pads	10	Circular Glass Cutter	148
Baghdadi Hand Saws	154	Circular Saw Blades	158 - 159
Band Saws	160	Claw Couplings	87
Barrel Pumps	75	Claw Hammers	137
Belt Punches + Sets	61 - 62	Cleaning Paste	65
Bevels	177	Cobalt Drill Bits	96
Bits	57 - 59	Coil Spring Compressors	33
Blow Guns	84	Combination Drill Bit Sets	107
Bolt Cutters	121	Combination Spanners	15, 18
Bow Saws and Bow Saw Blades	157	Concrete Core Cutter SDS Max	109
Brad Punches	63	Concrete Drill Bits	106
Brass Welding Rods	212	Conical Brushes	12
Brooms	14	Copper Hammers	136
Brushes	12 - 14, 143	Core Drills	102 - 104
Bumping Tools + Sets	34 - 35	Cork Pads	145, 235
		Countersinks	101
C		Crimping Tool Sets - hydraulic	122 - 125
C-Clamps	38, 152	Crimping Tool Sets - mechanical	124 - 126
Cable Boxes - BS	187-188	Cross Pein Hammers	34
Cable Boxes - Schuko	192	Cup Grinding Wheels	6
Cable Cutting Tools - Hydraulic	122 - 125	Cup Brushes	12 - 13
Cable Cutting Tools - Mechanical	127	Cutting Discs	4 - 5
Cable Extension Reels - CEE	189-191	Cutting Tool Sets	122 - 125



Index

	page		page
D		F	
Dial Indicators	177	Flap Wheels	10 - 11
Die Stocks	111	Flute Cutters	100
Dies	112	Felt Gliders	236
Diesel Pumps	80	Flood Lights	194-195
Discharge Spouts	67	Floor Brooms	14
Dividers	175	Floor Squeegees	14
Door Clamps	152	Flooring Trowels	139
Door Openers - electric	242	Foam Tapes	145
Door Stops	234 - 235	Forstner Bits	110
Door Weather Strips	225 - 226	Fretsaw Blades	155
Double Ended Ring Spanners	17	Fretsaw Frames	155
Double Ended Open Spanners	16	Fuel Cans	75
Drill Bits & Sets	96 - 110	Funnel Sets	66
Drill Chuck Arbors	112	Funnels	66 - 67
Drill Sleeves	112	Furniture Nails	222
E		G	
Ear Protections	216	Garden Shears	132 - 134
Earth Clamps	215	Glass Breaking Pliers	148
Electrician Screwdriver Sets	54	Glass Carrying Gloves	149
Electrician Screwdrivers	51 - 53	Glass Cutters	147
Electrode Holders	215	Glass Drill Bits	98
Electrodes	213 - 214	Glass Lifters	146
End Cutting Nippers	117	Glass Sliding Door Fittings	237
Engraver Sets	64	Gliders	235 - 236
Eyelet & Puncher	223 - 224	Glue Guns	204
F		Goggles (Safety)	215
F-clamps	153	Gold Polish	65
Face Protections	215	Granite Drill Bit Sets	107
Feeler Gauges	176	Granite Drill Bits	106
Fibre Discs	8 - 9	Grease Gun Accessories	72
File Handles	138	Grease Control Guns	79
File sets	114	Grease Couplers	72
Files	115 - 116	Grease Dispensors	76 - 77
Filter Regulators	81 - 82	Grease Guns	70 - 71
Filter Wrenches	39 - 40	Grease Guns - Compressed Air	70
Filters	81 - 82	Grease Guns - Industrial	71
Fixing Sets	218	Grease Hoses	73
Flap Discs	7	Grease Nipple Assortments	71
		Grease Nipples	74
		Grease Pumps - pneumatic	78



Index

	page		page
G		K	
Grease Supply Systems	78 - 79	Key Wrenches	41 - 48
Grinding Cups	6	Knockout Punching Tools	128 - 129
Grinding Discs	4, 6	Knotted Cup Brushes	12
Grip Pliers	36 - 38		
Grip Wrenches	121		
		L	
H		L-Squares	150 - 152
Hack Saw Blades	156 - 157, 159	Lead Seal Pliers	181
Hack Saws	157	Lead Seal Wires	181
Hammer Handles	138	Lead Seals	181
Hammers	34, 136 - 137	Lead Sheets	179
Hand Cleaning Paste	65	LED Lamps	194 - 202
Hand Saws	154 - 155, 157	Letter Punch Sets	64
Hand Taps	112	Letter Stencils	64
Hand Wire Brushes	14	Levelling Instruments	172
Handlamps	193	Lever Jacks	161
Hatchets	135	Lopping Shears	134
Head Lamps	202	Lubricators	81 - 82
Hedge Shears	132		
Hex Key Wrenches	41 - 48	M	
Hole Saw Arbors	113	Marble Drill Bit Sets	107
Hole Saws Bi-Metal	113	Marble Drill Bits	106
Hollow Core Bits SDS Max	109	Marking Crayons	217
Hooks	163, 230	Masking Tapes	232
Hose Clamps	87	Mason Cords	224
Hose Clips	217	Masonry Drill Bit Sets	107
Hose Reels	77, 88	Masonry Drill Bits	105
Hot Air Guns	203	Master Links	162
HSS Core Drills	102 - 104	Measures	69
HSS Drill Bit Sets	99	Measuring Tapes	167 - 170
HSS Drill Bits	96 - 98	Measuring Wheels	173
		Metal Polish	65
IJ		Metal Saws	155 - 157
Industrial Sprayers	92 - 94	Metal Wedges	138
Inflating Chucks	84	Micro Meter	177
Inspection Lamps	193	Mirror Caps	218
Jerry Cans	75	Mirror Clamp sets	218
Joint Brushes	12	Mirror Screws	218
Joint Pullers	31	Mirror Tapes	229
		Morse Taper Shank Drill Bits	97
		Mortise Bits	100



Index

	page		page
N		P	
Needle File Sets	114	Paint Rollers	142
Number Punch Sets	64	Polypropylene Cords	224
Number Stencils	64	Polyethylene Strings	224
Nut Wrenches	26 + 54	Pressure Gauges	89 - 90
Nylon Hammers	34	Protractors	178
Nylon Plugs	219 - 221	Pruning Shears	133 - 134
		Pry Bars	27
O		Pullers	28 - 32
Offset Screwdrivers	46	Puller Sets	29, 33
Oil Control Gun	79	Pumps	75, 78 - 80
Oil Dispensors	76 - 77	Punch Drivers	129
Oil Glass Cutters	147	Punch Pliers	182
Oil Pumps - Pneumatic	79	Punches	61 - 64
Oil Suction Guns	73	Putty Knives	148
Oilers	67 - 68		
		Q	
P		Quick Couplings	85 - 87
Paint Rollers + Frames	142		
Paint Spray Guns	83	R	
Parallel Pin Punch Sets	63	Rack Jacks	161
Parallel Pin Punches	62	Radiator Brushes	143
Parcel Tapes	233	Radiator Paint Rollers	142
Petrol Cans	75	Ratchets	21 - 24
Piano Hinges	179	Regulators	81 - 82
Pinching Bars	138	Repair Tapes	227 - 229
Pipe Bending Tools	131	Revolving Punch Pliers	182
Pipe Cutters	131	Rim Wrenches	26
Pipe Grip Wrenches	121	Roller Frames	142
Pipe Vice Stands	161	Rope Hoists	161
Piston Ring Compressors	39	Rotary Hammer Drill Bits	108
Piston Ring Pliers	40	Rotary Pumps	75
Planer Blades	160	Round Brushes	12 - 13
Plastic Finishing Trowels	140	Rubber Mallets	34
Plastic Hammers	34	Rulers	178
Pliers	117 - 120		
Pocket Knives	135		
Pocket Spring Balances	174		
Pocket Tape Measures	166		
Polish	65		



Index

	page		page
S		S	
Safety Hooks	163	Spanner Sets	18 - 19
Safety Inspection Lamps	193	Spanners	15 - 19
Sal Ammoniac Blocks	209	Spanning & Sealing Machines	180
Saws	154 - 159	Spark Plug Brushes	14
Scrapers	140	Spatulas	140
Screw Extractors	100	Spectacles	215
Screwdriver Bits	57 - 59	Spike Rollers	142
Screwdriver Sets	54 - 56	Spirit Levels	164 - 166, 171
Screwdrivers	49 - 53	Spray Guns	83
Scribers	175	Sprayers	92 - 94
SDS MAX Core Cutter	109	Squares	150 - 152
SDS Plus Chisels	109	Squeegees	14
SDS Plus Drill Bits	108 - 110	Steel Chains	161
Sealing Clips	181	Steel Collars	217
Sealing Compound	65	Steel Hooks	163
Seam Rollers	142	Steel Polish	65
Separators	32	Steel Shelves	240 - 242
Shears	132-134	Steel Straps	181
Sheep Shears	134	Steel Trowels	139
Shelving Systems	233 - 241	Step Drills	101
Shovel Handles	138	Strap Wrenches	39
Single Flut Cutter	100	Street Brooms	14
Silicone Sealant	141	Suction Lifters	146
Silver Polish	65		
Sledge Hammers	136	T	
Slogging Wrenches	20	T-Handles	22
Slotted U-Rails	179	T-Handle Wrenches	47 - 48
Snap-Off Knives & Blades	143	Tap Wrenches	111
Snips	130	TCT Core Drills	103
Sledge Hammers	136	Test Pumps	90 - 91
Slogging Wrenches	20	Thread Calipers	176
Slotted U-Rails	179	Threaded Rods	179
Snap-Off Knives & Blades	143	Tile Cutters	144
Snips	130	Tile Spacers	145
Socket Sets	21, 24 - 25	Tommy Bars	26
Socket Wrenches	25, 52, 57	Toggles	221
Soldering Guns	209	Tool Boxes - Metal	24, 95
Soldering Irons	208	Tool Sets	63
Soldering Powder/Liquids/Paste	211 - 212	Torches LED	196 - 201
Soldering Sticks	212	Torque Wrenches	23
Soldering Wires	210		



Index

	page		page
T		W	
Tower Pincers	117	Wall Plug & Screw Sets	219
Tube Brushes	14	Wall Plugs	219 - 221
Tube Cutters	131	Wall Uprights	238
Turn Blade Knife	160	Washing Guns	82 - 83
Trowels	139 - 140	Waste Oil Drainers	76
Tyre Inflating Guns	84	Waterpump Pliers	117
Tyre Levers	27	Wedges	138, 234
		Welding Electrodes and Sticks	213 - 214
U		Welding Glasses	215
U-Rails	179	Welding Goggles	215
Universal Joints	22	Welding Helmets	216
Universal Keys	121	Welding Powder	211
Utility Knives + Blades	143	Welding Rods	214
UV Adhesives	149	Welding Shields	216
		Wheel Brushes	13
V		Wheel Wrenches	26
Valve Spring Compressors	40	Wire Brushes	14
VDE-Pliers	119	Woodburning Pen	209
VDE-Screwdrivers	51 - 53	Wood Working Drill Bits	110
VDE-Pliers	119	Wooden Mallets	137
Vernier Caliper	174	Workshop Trolleys	95
Voltage Testers	205 - 206	Wrenches	23, 26, 39 - 48
Voltage Testers - Electronic	207		
Vulcanfibre Discs	8		



Sales Support





KISTENMACHER



KISTENMACHER

E.G. KISTENMACHER GmbH & Co. KG

Sachsenstrasse 5
20097 Hamburg, Germany

Phone +49 40 23 69 85 0
electrical@kistenmacher.de
www.kistenmacher.de



BRANCHES

Dubai, UAE
dubai@kistenmacher.de

Phone +971 4 222 1849



Jeddah, Saudi Arabia
jeddah@kistenmacher.de

Phone +966 50 564 9970

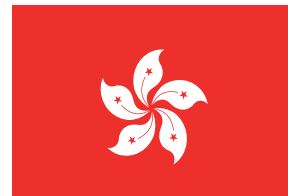

Hong Kong, China
china@kistenmacher.de

Phone +852 2887 6060